

Operation Manual

UV INKJET PRINTER ***JFX200-2513 EX***

Operation Manual

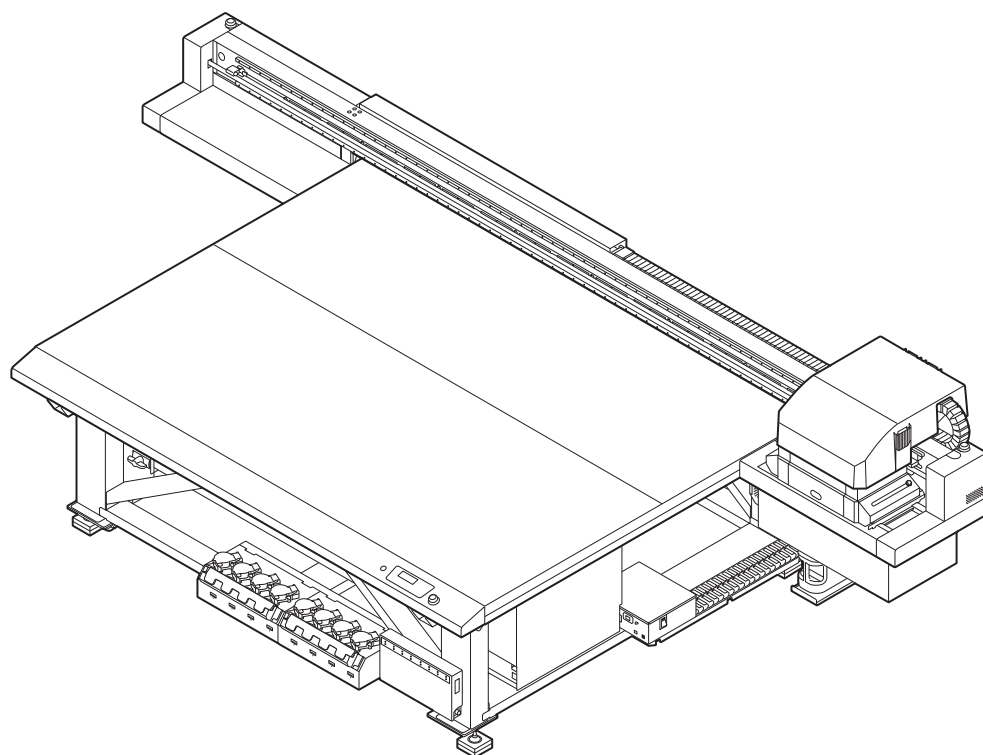

You can also download the latest manual from official website.

MIMAKI ENGINEERING CO., LTD.

<https://mimaki.com/>

D203431-23
Original instructions

TABLE OF CONTENTS

Introduction	6
For safe use	7
Symbols	7
Usage Warnings and Precautions	8
Cautions on Installation	14
Warning Labels	15

Chapter 1 Before Use

1.1 Usage Restrictions.....	20
Usage Restrictions.....	20
User Restrictions	20
Area Restrictions	20
1.2 Installing this Machine	21
Installation Environment	21
Where to Install This Machine	21
Fixing This Machine.....	22
Moving This Machine.....	22
1.3 Avoid These While Operating the Printer	23
1.4 Names of Parts and Functions	29
Front Side of this Machine	29
Rear Side and Right Side of this Machine	30
Operation Panel.....	31
Carriage	32
Capping Station	32
Stop Switch.....	32
1.5 Connecting the Cables	34
Connecting the USB Cables	34
Connecting Power Supply Cable	35
Connecting a LAN Cable	36
1.6 Ink Bottles.....	38
Types of Usable Inks	38
Setting Ink Bottles.....	38
Replacing an Ink Bottle.....	42
If the light-blocking cover comes off	45
Ink Bottle Lamps	45
Restrictions Regarding the Use of Ink	46
Ink End and Ink Near End.....	46
Storage of Ink Bottles	46
Precautions on Handling Ink Bottles.....	47
1.7 Media	48
Usable media sizes.....	48
Storing Media.....	48
Precautions when handling media.....	48
1.8 Notes Regarding Work Environment, etc.	50

Chapter 2 Basic Usage

2.1 Operation flow.....	52
2.2 Turning the Power On/Off.....	53
Turning the power on.....	53
Turning off the power.....	53
2.3 Setting up the Media.....	55
Setting up the Media.....	55
2.4 Move the illumination position of the UV-LED	58
Position of the UV-LED unit.....	58
2.5 Test printing	62
Examples of Plotting Failure	62
Relation between the head layout and the test patterns.....	63
Taking a Test Print.....	64
2.6 Head Cleaning	66
2.7 Printing the Data	68
Starting a Printing Operation	68
Aborting a Printing Operation	69
Deleting the Received Data (Data Clear)	69
Moving the Y-bar	69

Chapter 3 Convenient Usage

3.1 Changing the Point of Origin.....	72
Using JOG Keys to Change the Print Origin.....	72
Using FUNCTION menu to Change the Print Origin	73
3.2 Registering the Media Thickness.....	74
Registering the Media Thickness Manually	74
Registering the Media Thickness with the [UP] and [DOWN] Keys....	74
Automatic Checking of the Media Thickness	75
3.3 HEAD GAP Value	77
Registering the Head Gap Value	77
Checking the Head Gap Value	78
3.4 List of Functions.....	79
3.5 Adjusting the Bidirectional Print Drop Position	80
Correcting the Drop Position.....	80
3.6 Setting LOGICAL SEEK	82
3.7 Setting UV LEVEL	84
3.8 Reducing Stripes Between Passes.....	86
MAPS Function.....	86
Setting the MAPS2 function (4 color + special colored ink).....	86
3.9 WORK CHANGE Settings	90
3.10 Ionizer Settings.....	91
3.11 AUTO CLEANING Settings	92
3.12 Setting Nozzle Surface Cleaning Frequency	94
3.13 Other Settings.....	95

3.14 Machine Settings	96
AUTO Power-off Settings	97
Time Settings	97
Unit Settings	98
Key Buzzer Settings	99
Language Settings	100
Network Settings	101
External Stop I/F	102
3.15 Nozzle Check Menu	104
Nozzle Check Menu List	104
Printing Nozzle Check Flow	104
Print Operations During "Nozzle Missing" Judgment and Error Occurrence	105
Printing Nozzle Check Settings	105
Auto Nozzle Recovery Settings	107
Judgment Condition Settings	107
3.16 Resetting to Default Settings	109
3.17 Confirming Machine Information	110
Checking Machine Usage Status	110
Checking Version Information	111
Displaying other information	112

Chapter 4 Maintenance

4.1 Daily maintenance	116
Precautions for maintenance	116
About Washing Liquid	116
Maintenance timing	116
Maintenance of Machine Exterior	117
Table Maintenance	118
MBIS maintenance	118
LM guide cleaning	119
Ionizer Maintenance	119
4.2 Maintaining the Capping Station	120
Cleaning wiper and cap	120
Cleaning the NCU	126
Cleaning around the station	127
Washing the Ink Discharge Passage	128
When the Machine Is Not Used For a Long Time	129
4.3 Maintenance of Head Surroundings	132
Cleaning LED UV Unit	133
4.4 When Nozzle Clogging Cannot Be Solved	134
Filling with ink from the sub tank to the head	134
Washing of head nozzle	135
Washing the Head Nozzle (When Using the PR-200 INK)	137
Performing Air Purge	140
NOZZLE RECOVERY Function	144
4.5 Automatic Maintenance Function	149
Setting the refresh intervals	149
Setting the Cleaning Interval	150

4.6 Replacement of Consumables.....	152
Replacing the wiper	152
Replacing Carriage Filters	153
Disposing the Waste Ink	154
Replacing the waste ink tank before the waste ink tank confirmation message is displayed (1)	157
Replacing the waste ink tank before the waste ink tank confirmation message is displayed (2)	157
4.7 About Refilling the Cooling Water	159
Refilling the Coolant.....	160
4.8 Flushing Filter	162
Replacing the Flushing Filter	162
Replacing the flushing filter before the replacement message is displayed.....	163

Chapter 5 Troubleshooting

5.1 Troubleshooting	166
Power does not turn on.....	166
Machine does not start printing.....	166
Image quality is poor.....	166
Nozzle is clogged.....	167
Ink bottle error.....	167
Ink leakage	168
If the message "SHAKE WHITE INK BOTTLES" is displayed	168
If an error related to the sub tank occurs	169
If pressure abnormality occurs.....	170
5.2 Warning/Error Message.....	172
Warning message	172
Error message	175

Chapter 6 Appendix

6.1 Specifications.....	184
Machine specifications.....	184
Ink specifications	185
6.2 Order of Ink Bottles.....	187
6.3 Inquiry Sheet.....	188
6.4 LICENSE Library	189

Introduction

Thank you for purchasing the UV-LED curable inkjet printer JFX200-2513EX.

Read this operating manual ("this document" hereinafter) thoroughly and make sure you understand its contents to ensure safe and correct use of the product.

Please note that the illustrations contained in this manual are intended to show functions, procedures, or operations and may sometimes differ slightly from the actual machine.

Adobe, the Adobe logo, Acrobat, Illustrator, Photoshop, and PostScript are the trademarks or registered trademarks of Adobe Incorporated in the United States and other countries.

RasterLink and TxLink are trademarks or registered trademarks of Mimaki Engineering Co. Ltd. in Japan and other countries.

Other company and product names mentioned herein are the trademarks or registered trademarks of the respective companies in Japan and in other countries.

Unauthorized reproduction of any portion of this document is strictly prohibited.

© 2019 MIMAKI ENGINEERING Co., Ltd.

● DISCLAIMERS

- MIMAKI ENGINEERING REJECTS ALL LIABILITY FOR DAMAGE ARISING DIRECTLY OR INDIRECTLY FROM THE USE OF THE JFX200-2513EX ("THIS MACHINE" HEREINAFTER), WHETHER OR NOT THE PRODUCT IS FAULTY.
- MIMAKI ENGINEERING REJECTS ALL LIABILITY FOR DAMAGE, DIRECT OR INDIRECT, TO MATERIALS CREATED WHILE USING THIS MACHINE.
- USING THIS MACHINE IN CONJUNCTION WITH DEVICES OTHER THAN THOSE RECOMMENDED BY MIMAKI ENGINEERING MAY RESULT IN FIRE OR ACCIDENTS. SUCH INCIDENTS ARE NOT COVERED BY THE PRODUCT WARRANTY. MIMAKI ENGINEERING REJECTS ALL LIABILITY FOR DAMAGE, DIRECT OR INDIRECT, ARISING FROM SUCH INCIDENTS.
- USE ONLY GENUINE MIMAKI ENGINEERING ANTI FREEZING LIQUID. USE OF OTHER ANTI FREEZING LIQUID MAY CAUSE FAILURES OR REDUCE PRINT QUALITY. SUCH INCIDENTS ARE NOT COVERED BY THE PRODUCT WARRANTY. MIMAKI ENGINEERING REJECTS ALL LIABILITY FOR DAMAGE, DIRECT OR INDIRECT, ARISING FROM SUCH INCIDENTS.
- AVOID USING UV-LED UNITS OR UV POWER SUPPLY UNITS OTHER THAN THOSE SPECIFIED BY MIMAKI ENGINEERING. USING DEVICES OTHER THAN GENUINE MIMAKI ENGINEERING DEVICES MAY RESULT IN FAILURE, ELECTRIC SHOCK, OR FIRE. SUCH INCIDENTS ARE NOT COVERED BY THE PRODUCT WARRANTY. MIMAKI ENGINEERING REJECTS ALL LIABILITY FOR DAMAGE, DIRECT OR INDIRECT, ARISING FROM SUCH INCIDENTS.

● TV and radio interference



- The machine emits high-frequency electromagnetic radiation while operating. Under certain circumstances, this may result in TV or radio interference. We make no guarantee that this machine will not affect special radio or TV equipment.

If radio or TV interference occurs, check the radio or TV reception after turning off the machine. If the interference disappears when the power is turned off, the machine is likely to be the cause of the interference.

Try any of the following solutions or combinations of these solutions:











- Change the orientation of the TV or radio antenna to find a position where interference does not occur.
- Move the TV or radio away from this machine.
- Plug the TV or radio into a power outlet on a power circuit other than the power circuit to which this machine is connected.

For safe use

Symbols

In this document, symbols are used for explaining the contents of cautions on operation. The symbol to be displayed differs depending on the caution content. Please understand the meaning of each symbol and use this machine safely and correctly.

● Examples of symbols

Meaning		
	WARNING	Failure to observe the instructions given with this symbol can result in death or serious injuries to personnel. Be sure to read it carefully and use the printer properly.
	CAUTION	Failure to observe the instructions given with this symbol can result in minor or medium injuries to personnel.
	GENERAL WARNING	This symbol indicates that the items shown need to be noted. Specific notes are drawn in the figure  .
	GENERAL MANDATORY ACTION	This symbol indicates that the action shown must be executed. Specific instruction is drawn in the figure  .
	GENERAL PROHIBITION	This symbol indicates that the action shown is prohibited. Specific action that is prohibited is drawn in the figure  .
	IMPORTANT	Important notes for the use of this printer are given with this symbol. Understand the notes thoroughly to operate the printer properly.
	HINT	Useful information is given with this symbol. Understand the notes thoroughly to operate the printer properly.
	REFERENCE	This symbol indicates the reference page for related contents. Click the text to display the corresponding page.

Usage Warnings and Precautions

● In the event of abnormal conditions

WARNING



- If someone swallows ink or cleaning solution by mistake, keep him or her quiet and take them to see a doctor immediately. Do not let allow the person to swallow the vomit.
- If you inhale a great deal of vapor and feel ill, immediately move to a location with plenty of fresh air, and keep yourself warm and quiet. Consult a doctor as soon as possible.
- In the unlikely event that a foreign object such as metal, water, liquid enters the inside of this machine, turn off the power immediately. Afterwards be sure to unplug the power plug from the outlet. If used as it is, it may cause fire or electric shock.
- If ink leaks, turn off the main power switch and unplug the power cable. After that, contact your local distributor, our sales office, or service center.



- Immediately turn off the main power supply and disconnect the power cable from the machine if a problem such as an abnormal smell, smoke, or sign of spark occurrence is detected in the machine. If used as it is, it may cause fire or electric shock. Check first that the machine no longer produces smoke, and contact your distributor or a sales office of MIMAKI for repair.
- Never repair your printer by yourself since it is very dangerous to do so.

● Handling of ink and cleaning solution

WARNING



- Make sure to read the Safety Data Sheet (SDS) before handling ink and washing liquid.
- Some constituents are toxic to aquatic life. Prevent leakage into natural water systems or domestic wastewater.
- If ink adheres to the skin or clothing, immediately rinse with soap and water. If you get the ink in your eyes, wash them immediately with water and consult a doctor.
- Discard the waste ink according to the local regulations of the area where this printer is used.
- Be sure to store the ink and cleaning solution in a cold dark location. Store the cleaning solution in a location that is out of the reach of children.



- When handling ink and washing liquid, pay close attention to ventilation and be sure to wear the included safety glasses and gloves. The ink or washing liquid may get in your eyes.



CAUTION



- Use of ink other than that specified will damage this printer. Malfunctions caused due to the use of alternative ink are out of the scope of warranty. Please understand that the cost of repairs in this case is to be borne by the customer.
- Never refill an ink bottle with ink. Malfunctions caused due to refilling of the ink bottle are out of the scope of warranty, and our company does not assume any responsibility for the same.
- Do not use the ink designed for this printer with other printers. Doing so may cause damage to the printer.

● Handling of ink bottles

WARNING



- Precautions regarding ink are indicated on the Ink bottle. Read these carefully and make sure you understand the contents before using the product.
- Store ink bottles and the waste ink tank in a location that is out of the reach of children.

⚠ CAUTION

- If the ink bottle is moved from a cold to a warm place, leave it for more than 3 hours before use.
- Open the ink bottle just before use and be sure to use it promptly. If the bottles are left open for a long time, the printing quality may degrade.
- For device protection, do not use any ink other than the dedicated ink.



- Do not strike the ink bottle with great force nor shake it violently. Doing so may cause ink to leak out of the bottle.

● Be Careful with Moving Parts**⚠ WARNING**

- Do not place your fingers or other parts of body close to dangerous moving parts. There is a danger of injury.

● Warning Labels**⚠ CAUTION**

- Warning labels are affixed to this printer. Be sure to fully understand the warnings indicated on the labels. If any of the warning labels has become so soiled that the warning message is illegible or has come off, purchase a new one from your local distributor.

● Ultraviolet Rays (UV), UV-LED**⚠ WARNING**

- The LED UV unit becomes hot inside. Turn off the LED UV unit and perform maintenance once the device cools down adequately. It may cause burns.



- A small amount of UV light leaks out around the LED UV unit. Wear gloves, long-sleeved clothes, light-shielding mask, light-shielding glasses, and similar protection so that your skin and eyes will not be exposed to UV light.

(1) Direct exposure of skin or eyes to UV light may result in inflammation or skin cancer.

(2) Even if UV light is weak and not likely to cause inflammation, repeated exposure to it may result in a chronic disease.

(3) Viewing a lit UV lamp with the naked eye may cause eye pain or visual impairment.

(4) There is a danger of eye damage due to UV light.

- Acute impairment: sensation of having a foreign body in the eye, pain, flowing tears
- Chronic impairment: cataract, etc.



- Never look at the LED UV with your naked eyes when lit up. Doing so may cause pain in your eyes or visual impairment. Be sure to wear the included safety glasses.



- Do not apply ultraviolet (UV) light directly to your skin. Doing so may irritate your skin.

⚠ CAUTION



- Touching hot parts such as the LED UV with combustible materials may cause fire or smoke to be emitted. Leaving combustible materials under the LED UV unit for a couple of minutes may also cause fire or smoke emittance.



- Be sure to wear the included gloves when handling the glass on the bottom of the LED UV unit, and never touch it with bare hands. Doing so may significantly lower the UV ink curing level. If the glass becomes dirty, wipe it with clean gauze moistened with ethanol. (Do not use ethanol for cleaning the exterior cover. Doing so will cause the paint to peel off.)



- Always use only a LED UV device and UV power supply unit recommended by Mimaki. The use of any product other than our recommended products may lead to fire or machine damage. Malfunctions caused due to the use of non-recommended products is out of the scope of warranty, and our company does not assume any responsibility for the same.
- Do not drop the glass components, bump them against things, use excessive force on them or scratch them.

● Grounding Work

WARNING



- Increasing the number of power outlets requires installation work to provide grounding to protect against electric shock.
- Carry out the grounding work.
- Always perform grounding to prevent electrocution accidents.

● Installation Location and Operating Environment

WARNING



- To prevent ignition of the ink, do not allow any open flames in the place where the unit is used.



- Be sure to set up an appropriate ventilation system if using this printer in a closed room or a room with poor ventilation.
- This machine is not an explosion-proof type. Do not use the machine in a flammable atmosphere. There is a danger of explosion.
- When constructing an exhaust outlet, please observe the following cautions to prevent malfunctioning of this printer.
 - (1) The extractor outlet must be installed in accordance with applicable local EHS (environmental, health, and safety) guidelines.
 - (2) If the extractor outlet is fitted with a shutoff valve, the valve must be open when this product is in use.



- Do not use the machine in a flammable atmosphere (such as gasoline, flammable sprays, thinners, lacquers, dust, etc.). It may cause a fire or electric shock by ignition.
- Do not bring paper or cloth close to the LED UV unit or cover LED UV unit with it. Doing so may cause fire.



- Do not use in humid places. Do not splash water onto this machine. It may cause fire, electric shock or malfunctioning.



- Keep children away from this machine.

CAUTION



- Use the printer in a room with as little dust as possible.
- Keep children away from this machine.
- If dust adheres around the head, it may cause ink droplets to fall. Execute head cleaning.
- Maintain this printer in a level horizontal position.

● Do Not Climb on the Table

WARNING



- Never climb on the table where the machine is placed. Doing so may cause the board surface accuracy to go wrong.

● Power supply and voltage

WARNING



- This machine has parts that generate high voltage. Get the electrical work done only from a licensed electrician.



- The set of power cables provided with this machine is for use with this machine only. Cannot be used with other electrical devices. Also, please do not use the power cable set other than the enclosed. Doing so may result in fire or electric shocks.
- Do not use extension cords. Doing so may result in fire or electric shocks.
- Keep the power plug prong clear of any foreign object such as a piece of metal. Failure to do so may result in a fire or electric shocks.
- Do not plug too many leads into a single socket. Doing so may result in fire or electric shocks.
- Do not use the machine if the power cable or plug is damaged. Using the machine with damaged power cable may result in fire or electric shocks. Contact your service representative for replacement of the cable.
- Do not handle the power plug with wet hands. Doing so may result in electric shocks.
- Grasp by holding the plug itself when removing the power plug from wall outlet. Holding and pulling the power cable may damage the cable, leading to fire or electric shocks.
- Do not use the device at a power supply frequency other than the one indicated. Doing so may result in fire or electric shocks.
- Do not use the device at a power supply frequency other than the one indicated. Doing so may result in fire or electric shocks.



- Use this printer with the indicated power specifications. Be sure to connect the power cable plug to a grounded socket in order to prevent fire and electric shock. Failure to do so may result in fire or electric shocks.



- Take care not to damage, break or work upon the power cable. If a heavy material is placed on the power cable, or if it is heated or pulled, the power cable can break, thus resulting in fire or electric shocks.
- The main power circuit breaker should be turned on only by personnel with sufficient knowledge about operating this printer.

● Power Supply

WARNING



- Make sure the breaker is always on.

● Power Cable

WARNING



- Use the power cable provided.

● Disposal

WARNING



- If you want to dispose of this machine, please contact your local distributor or service center. If you want to dispose the machine by yourself, please contact an industrial waste processor.
- Give the waste ink or the ink bottles that you no longer to your local distributor or service center. If you want to dispose of them by yourself, please contact an industrial waste processor or dispose them according to local regulations.

● Handling Vacuum

WARNING



- Never disassemble or modify the vacuum. Also, do not touch the relief valve (pressure regulating valve) or block the vacuum exhaust port. This can cause a decrease in suction force, heat generation or malfunctions. (The vacuum is directly below the table.)

CAUTION



- Using this machine in a low temperature environment can sometimes cause the vacuum to emit a highpitched sound, but this is not a malfunction.

● Handling the antifreeze liquid

WARNING



- Use the antifreeze liquid recommended by Mimaki. There is a risk of cooling device failure if other antifreez liquids is used. Malfunctions caused due to the use of other anti freezing liquids is out of the scope of warranty, and our company does not assume any responsibility for the same.
- Do not directly touch the antifreeze liquid.
In case of touching skin or clothing, use soap and immediately flush it with running water.
If you get antifreeze liquid in your eyes, immediately and thoroughly wash your eyes with clean water. Then, consult a doctor as soon as possible.
- Be sure to read the Safety Data Sheet (SDS) before using the antifreeze liquid.
- If someone accidentally swallows antifreeze liquid, try to get the person to vomit, and then consult a doctor as soon as possible.
- Avoid causing ignition due to static electricity, impact sparks, and similar causes.
- If you accidentally touch hot anti freeze mixture, immediately rinse it off with soap and water, cool adequately with ice water and then consult a doctor as soon as possible.
- Use the following methods to dispose of unneeded anti freezing liquid.
 - (1) Absorb them into such materials as sawdust or a waste cloth, and then incinerate in an incinerator
 - (2) Clearly indicate the contents of the waste to be disposed of and subcontract the treatment of the waste to a licensed industrial waste disposal company



- When handling the anti freezing liquid, be sure to wear the included safety glasses and gloves.

**CAUTION**

- Be sure to store the antifreeze liquid in a cold and dark place. Also keep it out of the reach of children.

● Do not disassemble or modify this printer

WARNING

- Never disassemble or modify this machine or ink bottle. Disassembling or modifying will result either in electric shock or malfunction of this machine.

● Handling Media

WARNING

- Do not leave the media set on the machine when returning home for the night. This can cause dust to adhere to the media.

CAUTION

- Use our recommended media to ensure stable and high-quality printing.
- Be careful about the expansion and contraction of the media. Do not use media immediately after removing from the packaging. Media may expand or shrink depending on the temperature and humidity of the room. After opening the package, let the media sit for at least 30 minutes at the place of use before installing it in the device.
- Do not use curled media. This not only causes media jams, but also affects image quality. Straighten the media before using if it is severely curled. When storing coated fix-sized paper in rolls, make sure the coated surface is on the outside.
- Keep the media away from dust. Wiping dust off the media creates static electricity, which has a counterproductive effect.

● Maintenance

WARNING

- To prevent electric shocks during maintenance, always turn the main power switch off, and remove the power plug. Capacitors of some units may take one minute to discharge. Accordingly, start maintenance work three minutes after turning off the main power circuit breaker and disconnecting the power plug.



- Never touch the areas around where high temperature caution plaques are affixed. Otherwise, you may burn yourself. If you need to touch the high temperature area, wear heat-insulating gloves to protect your hands.



- When cleaning the head, wiper or cap, be sure to wear the included safety glasses and gloves.





- Using the printer in a place exposed to water will increase the possibility of electric leakage. Avoid using the printer in places exposed to water. Electrical leakage may lead to electric shock of personnel or fire.

CAUTION

- Foreign materials and dust may accumulate on the conductive and insulating parts after using this printer for an extended period, resulting in electrical leakage. Periodically clean such parts.
- Do not blow compressed air. Foreign materials and dust may be scattered, get inside the conductive parts and cause malfunction. Be sure to use a vacuum cleaner to vacuum off foreign materials and dust.
- To prevent accidents, be sure to carry out periodic inspection and replace parts requiring periodic replacement.
- There are parts to be replaced periodically on this machine. We recommend concluding a maintenance contract.
- After this printer is used long time, foreign materials or dust gathered on the stabilizer or other parts may cause electrical leakage or insulation deterioration, resulting in fire or smoke emittance. Periodically clean this printer and replace the deteriorated parts detected by insulation resistance measurement.
- Screws of conductive or other parts may become loose after extended use of this printer, resulting in fire or smoke emittance. Periodically tighten the screws.

Cautions on Installation

When installing this machine, take the following precautions.

WARNING

- This machine should be installed in a dedicated private room, in a location where it can be reliably isolated by physical means such as an enclosure. The isolated area should be set up so that no one can easily reach the printer and ink supply unit.
- This isolated area should be prohibited for everyone except the trainees of our safety education program or those who have been trained by such a trainee.
If an untrained person enters the restricted area while the machine is in operation, there is a risk of accidental contact with the Y-bar that is in the process of printing, resulting in injury.
- This machine should only be operated by the trainees of our safety education program or those who have been trained by such a trainee.

CAUTION

Use the printer under the following environmental conditions:

- Operating environment: 15 to 30°C (59 to 86°F) 35 to 65% Rh (without condensation)
- Accuracy assurance temperature: 18 to 25°C (64.4 to 77°F)



Do not use the printer in the following environments:





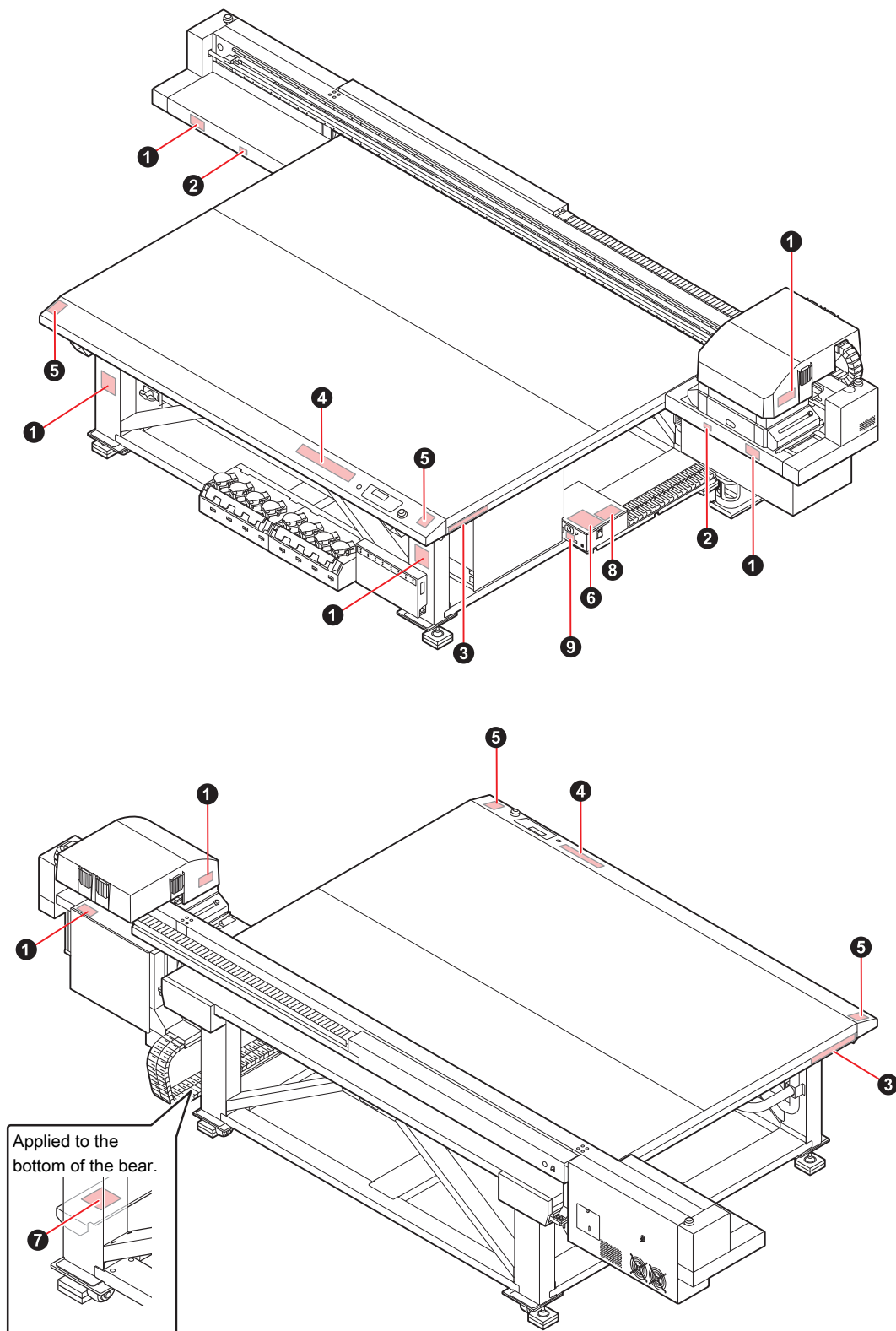

- Exposed to direct sunlight
- Places that are not level
(If the machine is not level, it may cause poor image quality)
- Where vibration occurs
- Exposed to direct air flow from an air conditioner or similar location
- Near where fire is used
- Places with lots of dust
- Places where there are chemicals

Warning Labels

Warning labels are affixed to this printer. Be sure to fully understand the warnings indicated on the labels.

If a warning label becomes illegible due to dirt or peels off, purchase a new one from your local distributor or our sales office.



No.	Order No.	Label
1	M909381	
2	M903330	
3	M906115	
4	M902663	
5	M905980	
6	M916117	
7	M909385	
8	M903281	<p>See SET UP GUIDE before connecting to the supply.</p> <p>電源を接続する前に、必ずセットアップガイドを読むこと。</p> <p>在接通电源之前请一定阅读安装说明书。</p>

No.	Order No.	Label
9	M907935	

Chapter 1 Before Use



This chapter

This chapter explains what you need to know before use, such as the name of each part of this machine and its installation method.

Usage Restrictions	20	Connecting the Cables	34
Usage Restrictions	20	Connecting the USB Cables	34
User Restrictions	20	Connecting Power Supply Cable	35
Area Restrictions	20	Connecting a LAN Cable	36
Installing this Machine	21	Ink Bottles	38
Installation Environment	21	Types of Usable Inks	38
Where to Install This Machine	21	Setting Ink Bottles	38
Fixing This Machine	22	Replacing an Ink Bottle	42
Moving This Machine	22	If the light-blocking cover comes off	45
Avoid These While Operating the Printer	23	Ink Bottle Lamps	45
Names of Parts and Functions	29	Restrictions Regarding the Use of Ink	46
Front Side of this Machine	29	Ink End and Ink Near End	46
Rear Side and Right Side of this Machine	30	Storage of Ink Bottles	46
Operation Panel	31	Precautions on Handling Ink Bottles	47
Carriage	32	Media	48
Capping Station	32	Usable media sizes	48
Stop Switch	32	Storing Media	48
		Precautions when handling media	48
		Notes Regarding Work Environment, etc.	50

1.1 Usage Restrictions

Usage Restrictions

This machine can be dangerous due to parts that move at high speeds, parts with high temperature and UV curing units. This machine is to be used only by those having complete understanding of dangers associated with these parts.

User Restrictions

This machine should only be operated by the trainees of our safety education program or those who have been trained by such a trainee.

Area Restrictions

- Only adequately trained and versed individuals are allowed to come closer to the equipment. Set area restrictions within the range shown in the following figure. As for the method of area restriction, the machine should be installed in a dedicated room, and it should be enclosed for everyone to understand that it is a danger zone.
- The danger zone should be prohibited for everyone except the trainees of our safety education program or those who have been trained by such a trainee. If an untrained person enters the restricted area while the machine is in operation, there is a risk of accidental contact with the Y-bar that is in the process of printing, resulting in injury.
- Follow EN ISO13857 standards when securing the area with safety trellis.
- When installing the setup in a dedicated room, install locks and interlocks on the door of the room, and lastly conduct risk assessment at the installation site before use.

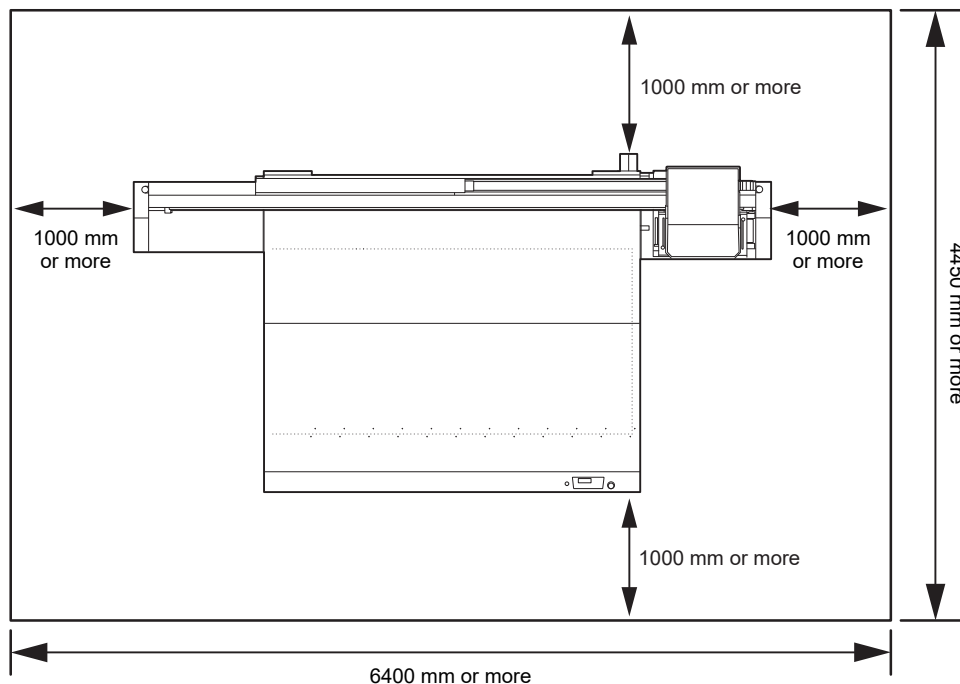

1.2 Installing this Machine

Installation Environment

- Do not use in a dusty place. It may lead to problems in the printer or poor printing.
- For stable printing, use this machine in an environment with a temperature in the range of +15 °C to +30 °C (59°F to 86°F) and Rh in the range of 35 to 65%.

Where to Install This Machine

Secure a suitable installation space before assembling this machine.

The place of installation must have enough space for not only this machine itself, but also for the printing operation.

Model	Width	Depth	Height	Gross weight
JFX200-2513EX	4400 mm	2450 mm	1250 mm	600 kg

Important!

- A service engineer will perform installation work of this machine. At this time, he/she will contact you and explain about the usage and the installation of this machine.

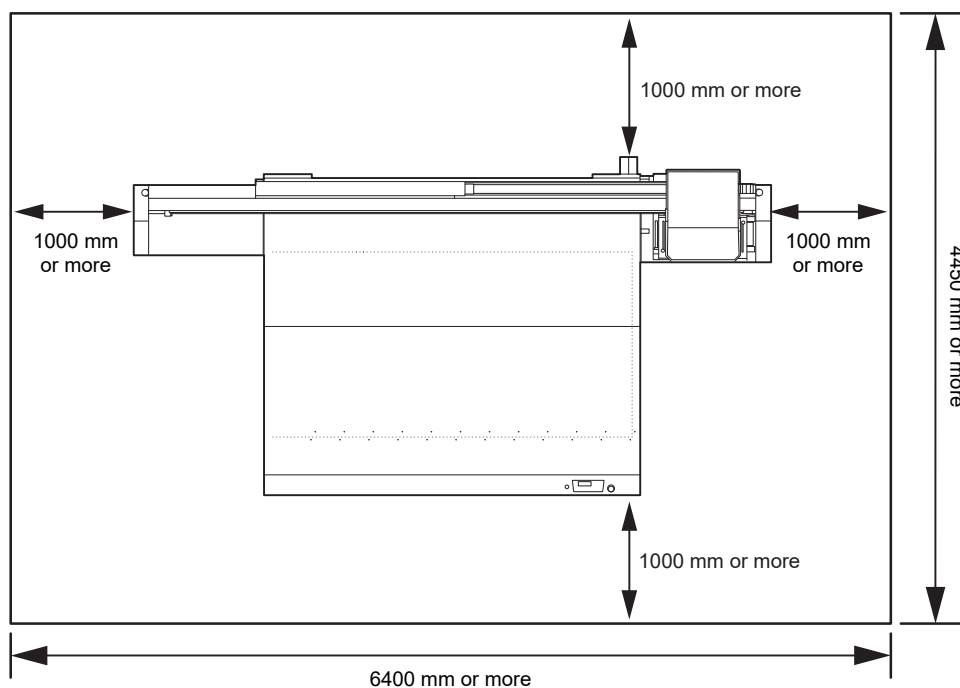

- If you usually use photographic fixers, refrain from installing this machine in a room filled with the steam of photographic fixers. If this machine is installed in a room filled with photographic fixers, the ink adhering to the head solidifies and the image quality degrades no matter how many times the head is cleaned, or the nozzles may get clogged.
- Apart from photographic mixers, the same problem occurs if you keep this machine in an environment where acidic steam (acetic acid, hydrochloric acid, etc.) is generated.
- Do not use the machine in an environment full of metal cutting fluids or materials containing highly volatile substances (amines, amine-denatured alcohols). Also, isolate ink, maintenance kits and the machine from such an environment. This may cause nozzle clogging.

Fixing This Machine

The legs of the machine have level feet to fix the machine.

Before turning on the power, make sure that the printer body is fixed with the leveling feet.

The printer body may start moving during operation if it is not fixed with the leveling feet.

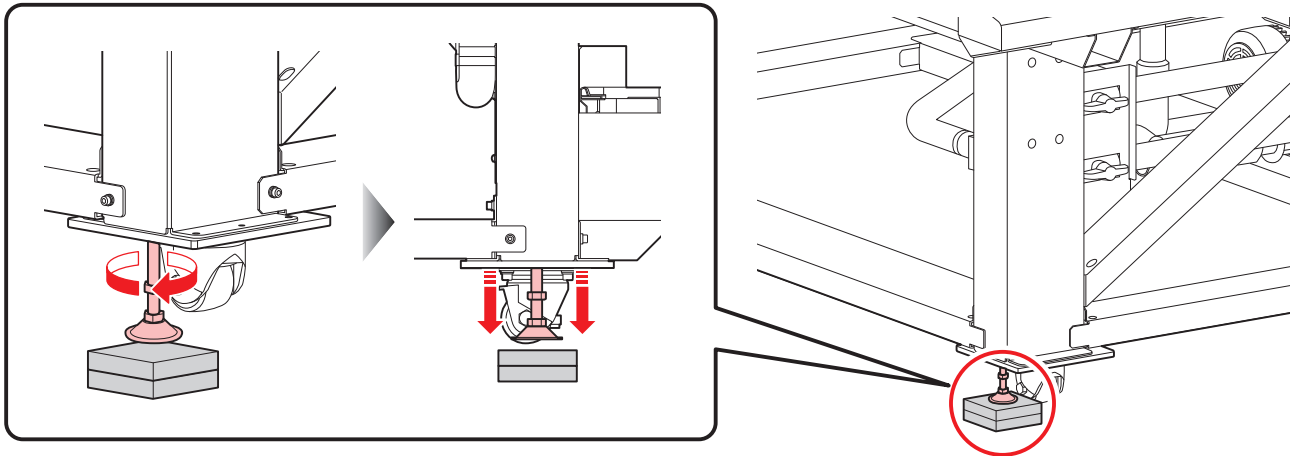

- Place the provided resin (gray) base plate between the leveling feet and the floor. We recommend that you use a floorboard to hold the weight of the printer.

Moving This Machine



- Before moving this machine, contact our sales office or your local distributor. If you move it by yourself, failure or damage may occur. When moving this machine, contact the experts.

1.3 Avoid These While Operating the Printer

Doing the things mentioned below when the printer is in operation might result in an injury.

- **Do not put your hands or any object on the table**

Do not put your hands on the movement channel of the carriage when the power is on. Also, do not put anything on the table other than the printing paper. Make sure that the thickness of the paper is 50 mm (1.97 inch) or less.



- **Do not disturb the carriage operation**

Do not manually move the carriage during operation (during printing or cleaning). If the carriage is manually moved during operation, an operational error message is displayed.



- **Do not put your hands or any object on the bearing part**

Do not put your hands, feet or any object on the Y-bar or on the bearing part on the right side of the main body.



- **Be careful not to get your hands pinched in the gap between the Y-bar and the carriage**

There is a risk of a person getting handicapped due to crushing or shearing if their hands or other body parts get caught between the Y-bar and the carriage.

Do not put your hands in the gap between the Y-bar and the carriage when the power is on.



- **Be careful not to get your hands pinched in the gap between the carriage and the table**

Do not put your hands in the gap between the carriage and the table when the power is on.



- **Do not put your hands or any object in the moving range of the carriage**

If the carriage moves too fast, your hands may get caught in it.



- **Keep your hands away from the Y-bar and the carriage when the power is on**

There is a risk of hands getting crushed due to the movements of Y-bar and carriage.
Keep your hands or other body parts away from this area and the printing range when the power is on.

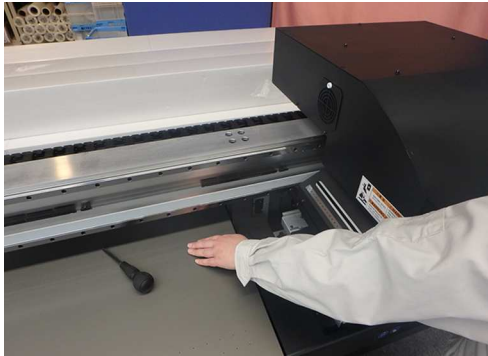

- **Be careful not to get your hands caught in the carriage or the maintenance station portion**

Do not put your hands in the carriage or the maintenance station portion.



- **Be careful not to get your hands pinched in the gap between the Y-bar and the table**

Do not put your hands in the gap between the Y-bar and the table when the power is on.



- **Be careful about belt winding malfunction**

Be careful not to get your hands dragged into the Y-bar belt. There is a risk of hurting your hands or objects getting sucked.



- **Do not place any object in front of the exhaust port of suction vacuum**

The object may get deformed due to the heat released from the exhaust port.

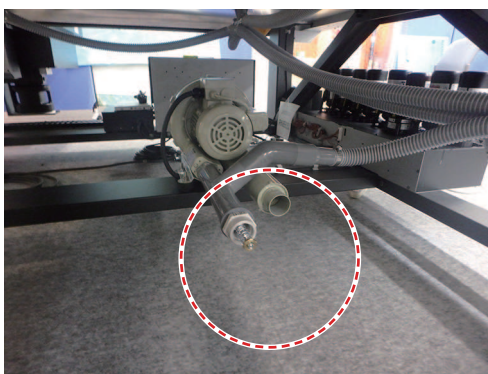

- **Do not crawl under the table when the power is on**

It is extremely dangerous as you may get caught in the fixed parts or the movable parts under the table.



- **Do not bring your hands anywhere near the rack gear and the motor cover under the table**

You may get your hands caught in the gears resulting in injury.



- **Be careful not to accidentally press the key panel switch by mistake**

Pressing this switch accidentally may cause sudden operation leading to an unexpected accident.

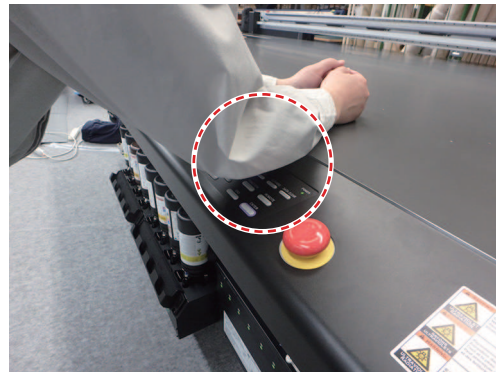

- **Be careful not to look directly at the UV light**

Do not directly look at the UV light.

- Be careful when your head and carriage are at the same level; for example when you are sitting on a chair while working.
Be particularly careful of UV light leakage when setting carriage and thick media.
- Be careful about UV light leakage at each of the following spots when printing.
Edge of the table
Back side of the carriage (behind Y-bar)
Top of the carriage part

Also, you may burn yourself from the LED UV unit and the parts around it, that have turned hot. Be careful not to touch.

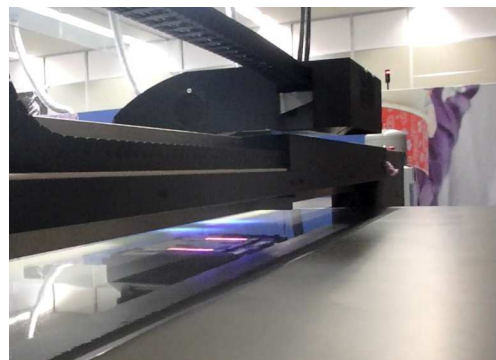
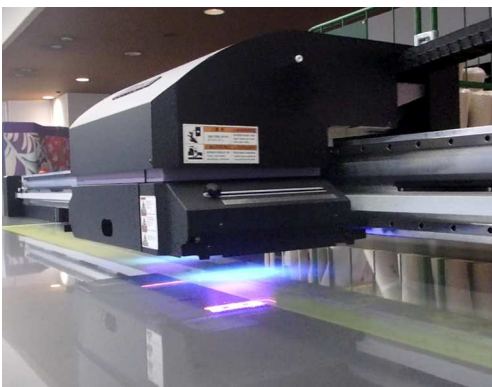

- **Wear safety glasses when using the machine**

It is recommended to wear safety glasses when using the machine to prevent eye damage due to UV light leakage.

● **Pay attention to following when replacing the ink**

- To prevent the ink from sticking to your hands or eyes when it splashes, be sure to wear the included safety glasses and gloves.
- Do not pull the ink cover too much.
Pulling it too much might damage the tubes and cables.
- Replace the ink bottle after cleaning the surroundings with a waste cloth, etc. The portion around the bottle becomes dirty as the ink oozes from the float part.

● **Wear safety glasses and gloves when performing maintenance**

When performing maintenance such as ink replacement, be sure to wear the included safety glasses and gloves.

Also, wear a gas mask if necessary.

1.4 Names of Parts and Functions

Front Side of this Machine

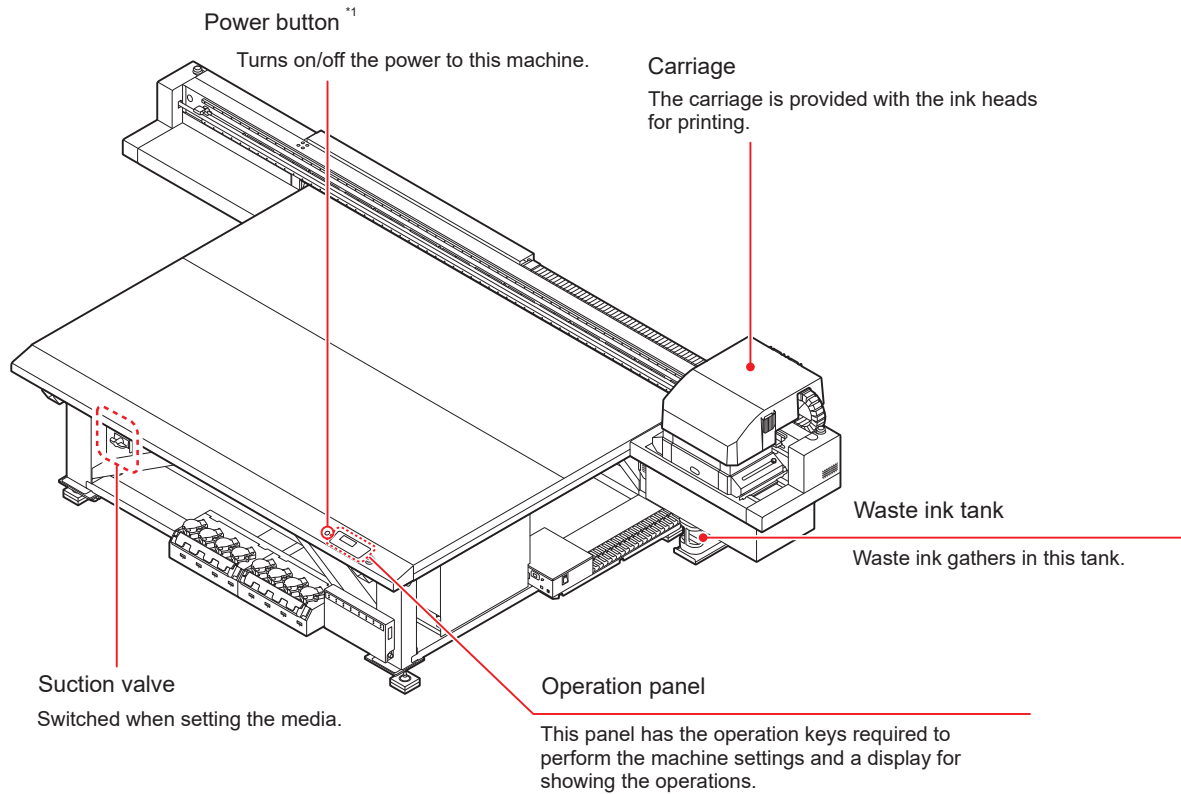

*1. When the power button is turned on, it lights in green, and when it is off, the light goes out. The ink clogging prevention function is periodically operated even when the power button is off. (Automatic maintenance function)

Rear Side and Right Side of this Machine

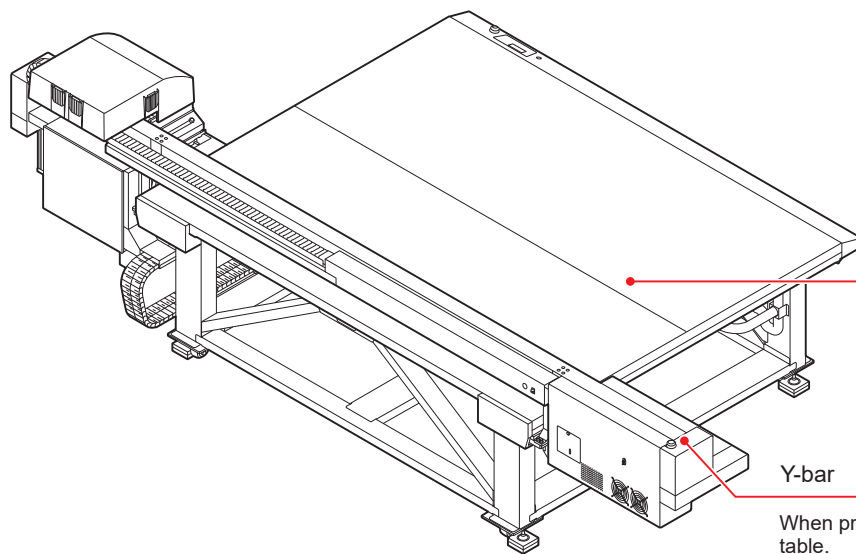

Table

Set the media on it.
There are suction holes on the table to
absorb the media when the vacuum is
turned on.

Y-bar

When printing starts, it moves along the top of the
table.

Operation Panel

Use the operation panel to perform settings for printing or operate this machine.

[VACUUM] key
Press to attach the media on the table.

[UP] key
Press when raising the carriage.

[DOWN] key
Press when lowering the carriage.

[ADJUST] key
Performs the adjusting functions such as drop position correction.

[MAINT.] key
Performs the maintenance functions such as station maintenance.

POWER Lamp
Lights up when the power is turned on.

[TEST] key
Prints test patterns to check for possible printing failures such as ink clogging.

[CLEANING] key
Performs head cleaning if there are ink clogs.

[DATA CLEAR] key
Deletes the data received by this machine.

Display
Displays the status of this machine, set items and errors.

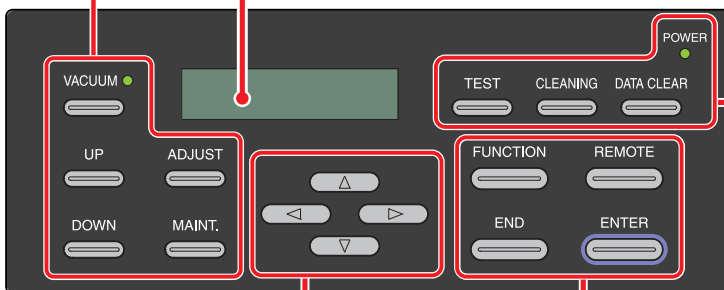

JOG keys ◀ ▶ ▲ ▼
Use these keys to shift the head or the Y-bar in LOCAL mode. You can also use these keys to select a printing condition.

[FUNCTION] key
Press to use the various functions.

[END] key
Press to finish the setting or cancel the setting.

[REMOTE] key
Press to switch between [REMOTE] and [LOCAL].

[ENTER] key
Press to confirm a setting.

Carriage

The carriage is provided with the heads for printing and LED UV unit.



- Do not look at the light emitted from the LED UV with a naked eye when lit.
- Do not touch the LED UV unit when the LED is lit or just after it is set off. You may suffer serious burns, as the unit is very hot.

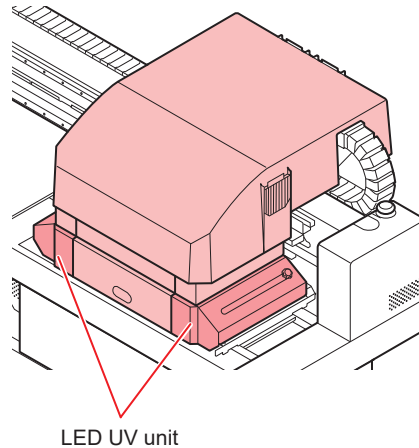

Capping Station



- When cleaning the inside of the capping station, be sure to wear the included safety glasses and gloves. Otherwise, the ink may get into your eyes.



The capping station consists of parts such as ink caps and the wipers necessary for maintenance of the heads.

The ink cap prevents the nozzles in the heads from drying up.

The wiper is used for head cleaning.

The wiper is a consumable good. If the wiper is deformed or the media is stained, replace the wiper with a new one.

 ["Replacing the wiper"\(P. 152\)](#)

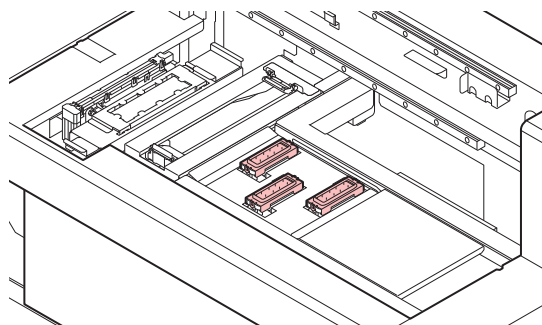

Stop Switch

Press the switch when you want to stop the machine for security reasons.

There is one stop switch on the front side of the machine, and one each on the left and right edge of the Y-bar.

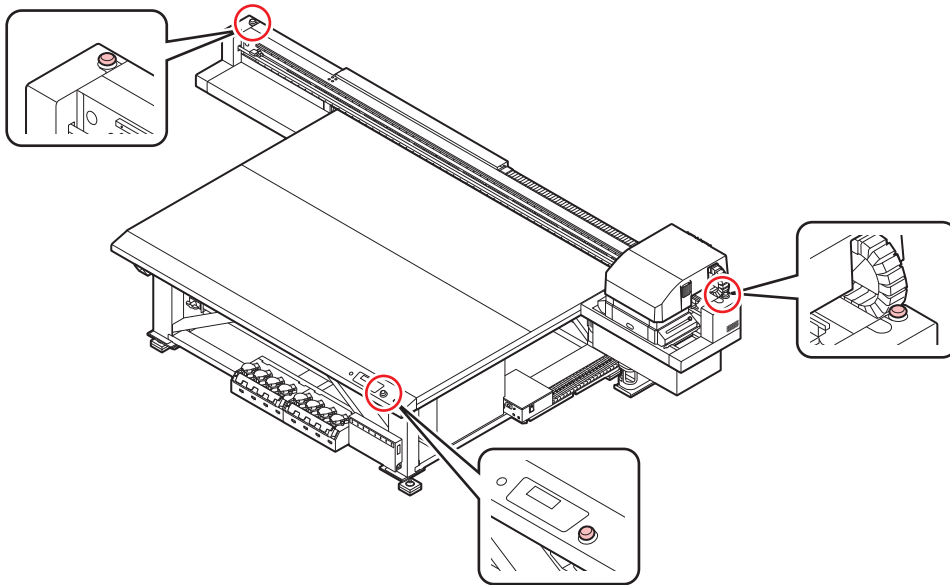

When you press the stop switch to stop this machine, follow the procedure given below to release it.

- (1) Resolve the fault.
- (2) After safety verification, lift (or rotate) the switch to release it.
- (3) Press the [ENTER] key.

1.5 Connecting the Cables

Connecting the USB Cables

Connect this machine to the PC using a USB 2.0 interface cable.

Important!

- Your RIP must be compatible with the USB 2.0 interface.
- If the USB 2.0 interface isn't attached to the PC, contact your nearest RIP manufacturer or our sales office.

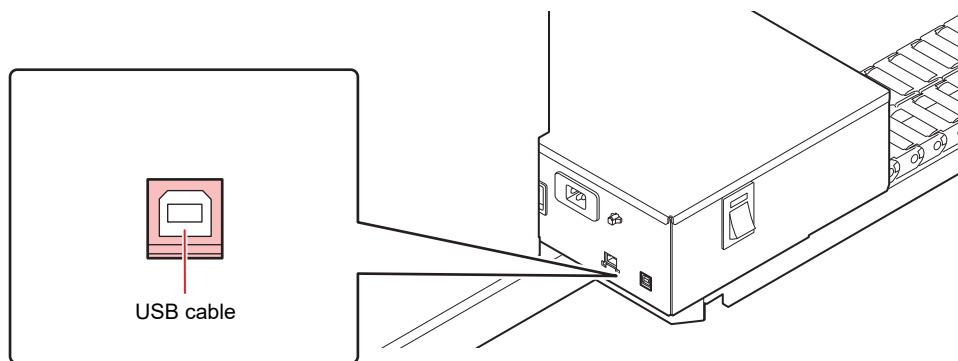

Notes on USB 2.0 Interface

Important!

- Your RIP must be compatible with the USB 2.0.

● When multiple machines are connected to one personal computer

When multiple machines are connected to one personal computer, the computer may not recognize all of these machines normally.

In case of a personal computer with multiple USB ports, reconnect this machine to another available USB port, and check if it is recognized. If the machine is not recognized even in the new USB port, use the USB 2.0 repeater cables available in the market. (However, the distance between the machine and the personal computer should be 20 m or less.)

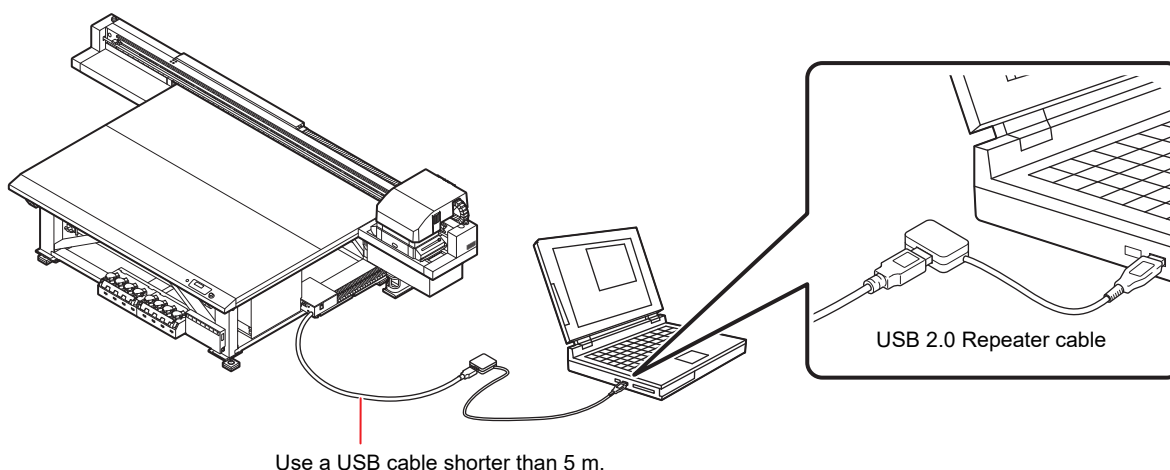

● Notes on peripheral devices in USB high speed mode

When a peripheral device (USB memory or USB HDD) to be operated in USB high speed mode is connected to the same personal computer to which the machine is connected, the USB device may not be recognized.

When the machine is connected to the personal computer to which an external HDD is connected via USB, the speed of data output to the machine may drop. This may cause the head unit to stop temporarily at the right or left end during printing.

Use a USB cable of 5 m or less. If a longer cable is required, use a commercially available USB 2.0 repeater cable.

● Removing a USB Memory

If a USB memory module is inserted in the personal computer to which the machine is connected, click [Stop] in the [Safely Removing Hardware] window.

It may cause the [ERROR 201 COMMAND] error.

Copy the data onto the hard disk before you output it for printing.

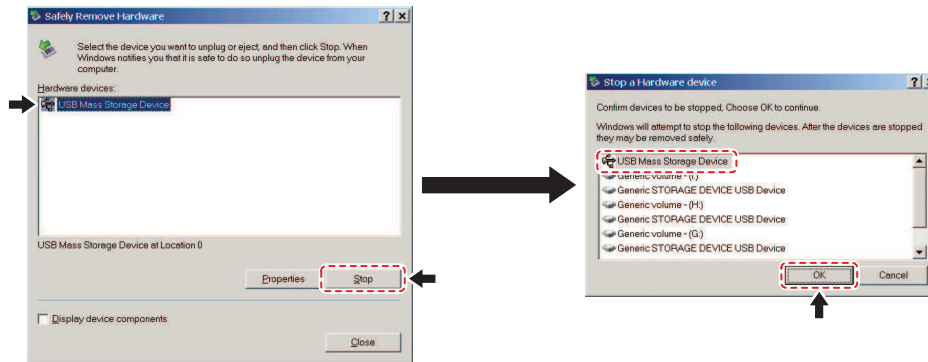

Connecting Power Supply Cable

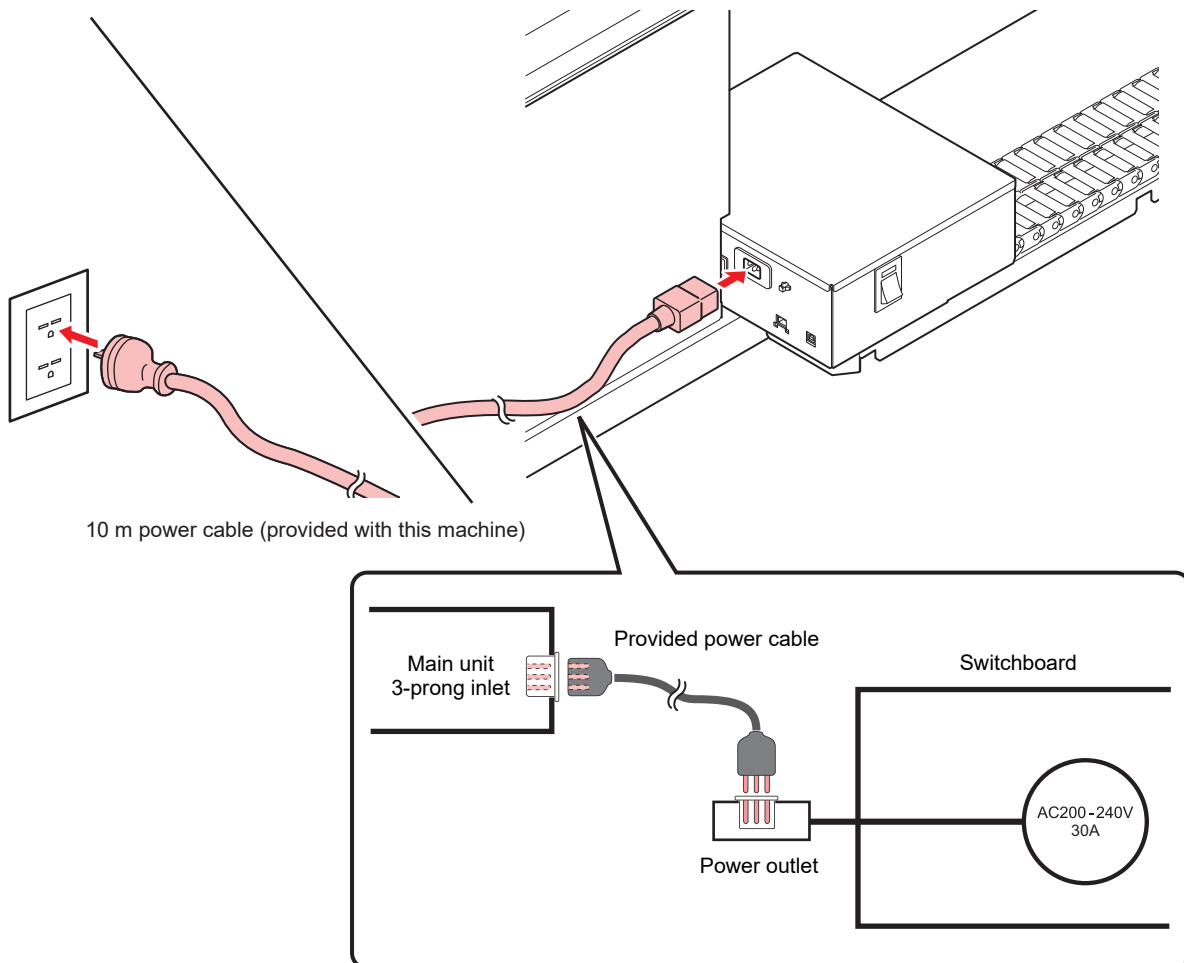

Connecting a LAN Cable

Observe the following precautions when connecting the LAN cable.

- Important!**
- Make sure you push it in firmly until you hear a clicking sound.
 - Do not plug or unplug the cable while data is being transferred.

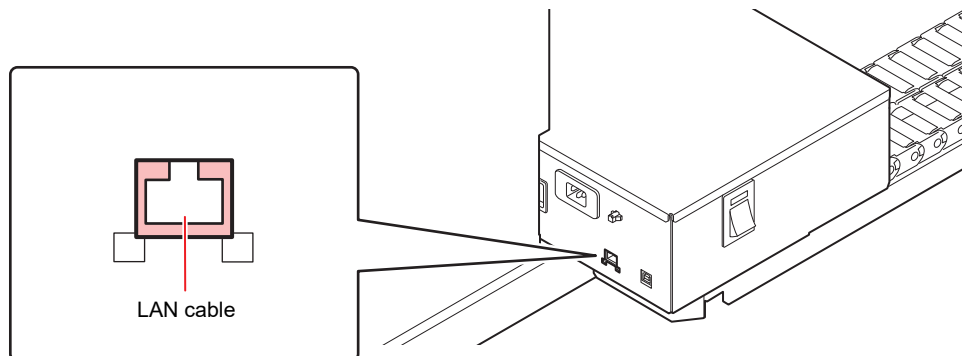

Printing Data via a Network

If you want to print data via a network, you must construct the network in the following environment.

Constructing in an improper environment may cause printing to stop.

- Use Category 6 and above LAN cables.
- Use 1000BASE-T compatible PCs and switching hubs.

- Important!**
- Make sure the printer and the PC sending the print data are in the same network.
 - They cannot be connected through a router.

● Connecting directly to the printer

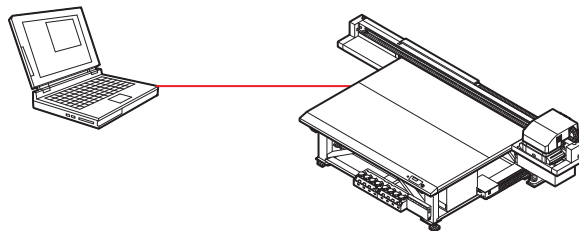

● Connecting through switching hubs

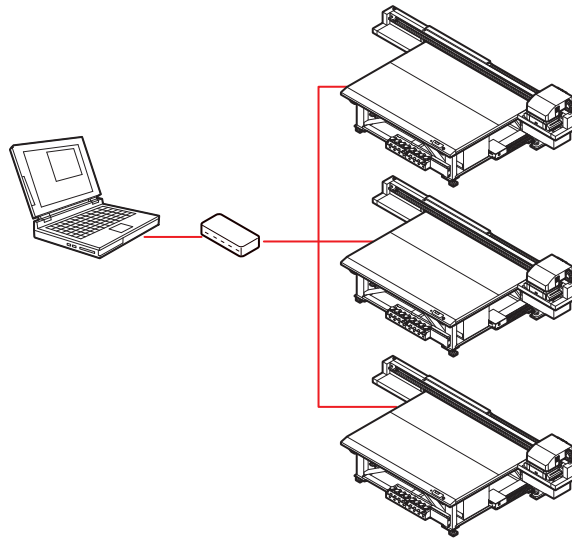

Printing cannot be done unless the PCs and devices connected to the printer are 1000BASE-T. After connecting, check the following:

1. Check the printer screen display.
 - From the LOCAL screen or MEDIA DETECT screen, press the [ENTER] key several times to display the information screen.
 - Check whether the LAN status field displays [1000 Mbps].

1.6 Ink Bottles

Types of Usable Inks

Following inks can be used with this machine.

4-color + white + clear model (LUS-150, LH-100, LUS-120, LUS-350, LUS-211)	Uses one bottle each of cyan, magenta, yellow, and black and two bottles each of clear and white
4-color + white + clear + primer model (LUS-150, LH-100, LUS-120)	Uses one bottle each of cyan, magenta, yellow, black, clear, and primer and two bottles of white
4-color + white model (LUS-150, LH-100, LUS-120, LUS-350)	Uses one bottle each of cyan, magenta, yellow and black and four bottles of white (When using this ink set, OPT-J499 is required.)
6-color + white model + clear (LUS-150, LH-100)	Uses one bottle each of cyan, magenta, yellow, black, light cyan, and light magenta and two bottles of white

ClearInk to be used varies depending on the ink type used.

Ink type	Ink type of ClearInk
LUS-150	LH-100
LH-100	LH-100
LUS-120	LUS-120
LUS-350	LUS-350
LUS-211	LUS-211

Please note that a combination other than those mentioned above cannot be used.

Setting Ink Bottles

1 Take out the ink bottle and gently shake it side to side 20 times or more.



- To prevent the ink from leaking when the bottle is shaken, wear hand gloves and close the lid of the ink bottle with a paper towel. Then shake the bottle from side to side at least 20 times to ensure a slow ink flow.



- Make sure that the lid is closed tightly before shaking the bottle.
- Be careful while shaking the bottle, because the ink may leak to outside if you shake the bottle too hard.
- If only a small amount of ink is remaining, it may not be possible to stir it properly. Hence, to stir the ink properly, tilt the ink bottle until it becomes vertical.

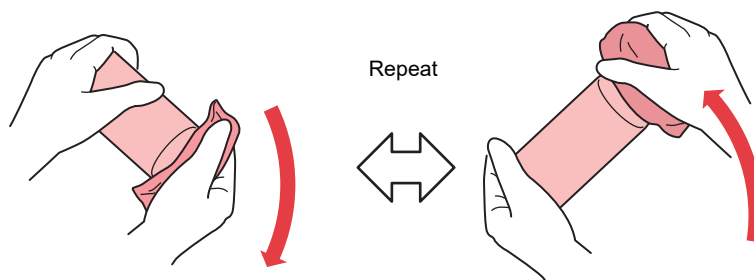

Hold down tightly with a paper towel and shake well

2 Remove the cap of the ink bottle.

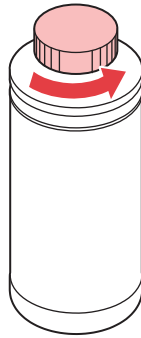

Important! If there is a seal covering the mouth of the ink bottle

- Use a tool such as a cutting knife to cleanly cut out a circular piece of the seal. If any pieces of the seal are leftover, it may cause the ink to leak.

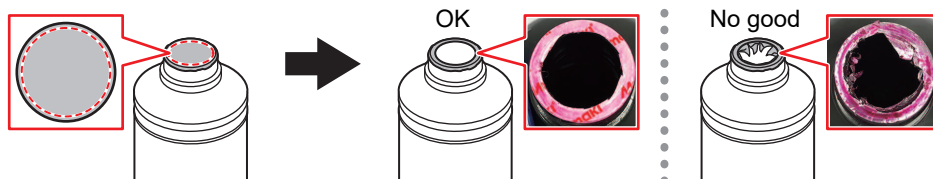

- Take care not to damage the mouth of the ink bottle. Any damage may result in ink leakage.
- Take care to prevent any pieces of the seal from dropping into the bottle. If a bottle that contains pieces of the seal is used, there is a risk that it will block the bottle cap and interrupt the supply of ink.

3 Set the specialized cap on the ink bottle.

- The cap to be used differs depending on the type of ink to be used.

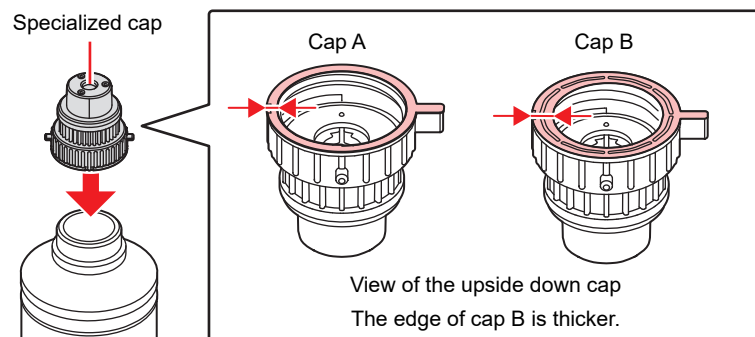

Type of ink	Cap Used
LUS-150 ink	Cap A
LH-100 ink	Cap B
Primer ink	Cap B
LUS-120 ink	Cap B
LUS-350 ink	Cap B
LUS-211 ink	Cap B



- Wipe off any ink or maintenance liquid remaining on the ink bottle or bottle cap. Otherwise there is a risk of ink leakage due to the bottle cap spinning freely.



- Check to confirm that there is no foreign matter, such as paper towel scraps or dust, adhering to the bottle cap. Continued use if soiled may result in foreign matter blocking the ink, causing ink leakage.

4 Use a fastening jig to close the specialized cap.

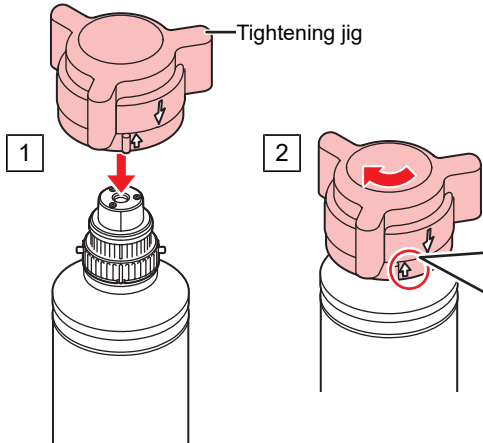

[SPA-0232]



Position the upper arrow within this range!

Good example



Bad example



[SPA-0328]



Position the upper arrow within this range!

Good example

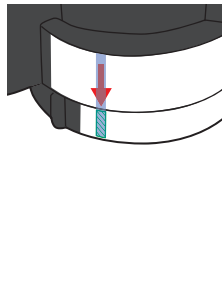

Bad example

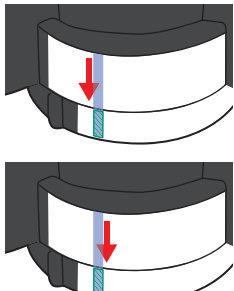

- Do not overtighten the bottle cap. Doing so may result in damage, leakage of ink, or cause it to spin freely. If the range indicated above is exceeded, loosen the bottle cap and then start again.
- Do not leave an ink bottle with the bottle cap attached for an extended period of time. Disregarding this precaution may cause the ink to harden.

5 Turn the bottle upside down to make sure that the ink does not leak.



- Important!**
- Do not leave the ink bottle with the specialized cap attached in a location where it is exposed to light for a long period of time. Doing so may cause the ink inside the bottle to harden.

6 Set the ink bottle over the tank.

- Move the tank lever completely to the right and set the ink bottle.

- Important!**
- Never rotate the ink bottle after setting it over the tank. Doing so may result in ink leakage.

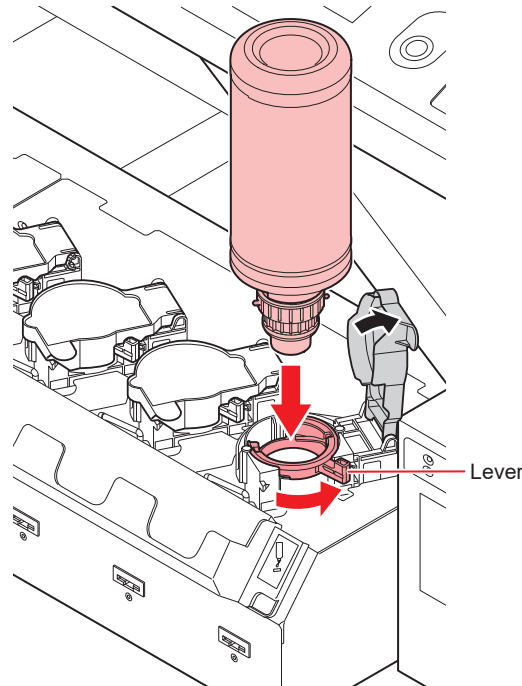

7 Turn the tank lever from right to left.

8 Insert the Ink IC chip.

- Insert the Ink IC chip with its metal part on the left. Inserting an Ink IC chip with its wrong side inward may damage the Ink IC chip or cause it to malfunction.
- Do not touch the metal part of the Ink IC chip. The static electricity generated when you touch the metal part may damage the Ink IC chip and/or cause reading errors due to transfer of dirt to or development of scratches on the chip surface.
- See ["Order of Ink Bottles"\(P. 187\)](#) for setting the order of ink bottles.

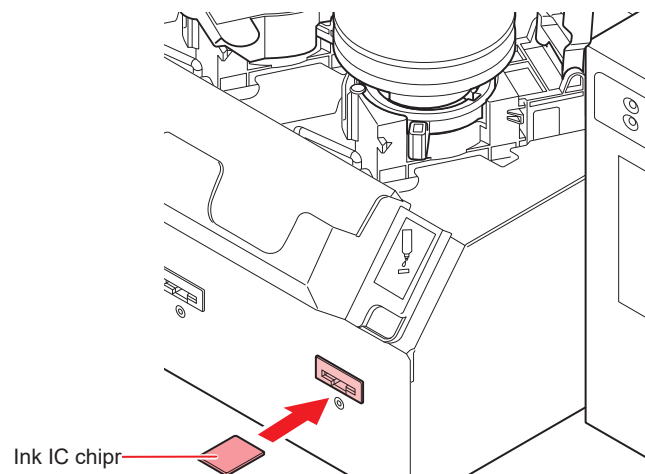

Important!

- The Ink IC chip has information on items such as ink color, remaining amount of ink, expiration date. When setting an ink bottle, insert the Ink IC chip included in the ink bottle package into the Ink IC chip insertion port provided on the ink cover.
- If the Ink IC chip not meant for a particular ink bottle is inserted, it may cause poor image quality.
- A mark indicating color information is pasted on the Ink IC chip.

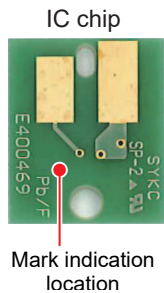

Ink Color		Cap Used
Black	●	One black circle
Cyan	●	One blue circle
Magenta	●	One red circle
Yellow	●	One yellow circle
Light cyan	●●	Two blue circles
Light magenta	●●	Two red circles
White	○	One white circle
Clear	○○	Two white circles
Primer	○○○	Three white circles

Replacing an Ink Bottle

When [INK END] or [INK NEAR END] are shown on the display, perform the following procedure:

When [INK END] is displayed

- 1 Turn the tank lever from left to right edge.

Important!

- Make sure not to rotate the ink bottle. Doing so may result in ink leakage.

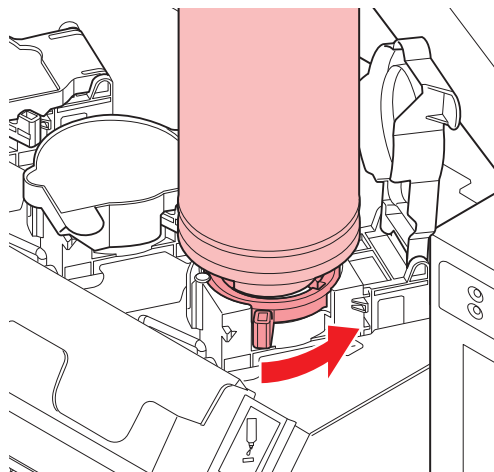

2 Lift the ink bottle vertically.

Important!

- When the ink bottle is removed from the tank, make sure that the light-blocking cover is shut.
- If the lid is not shut, close it manually. If the light-blocking cover is left open, the ink may harden.

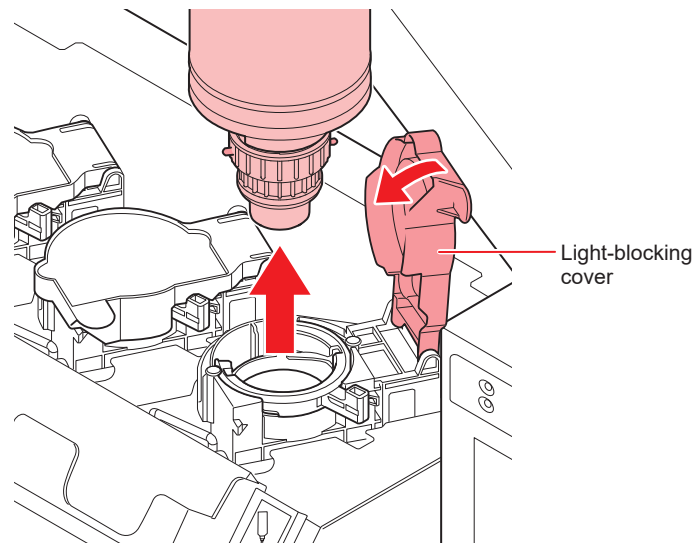

3 Wipe off the ink adhering to the bottom of the cap with the wiping filter.

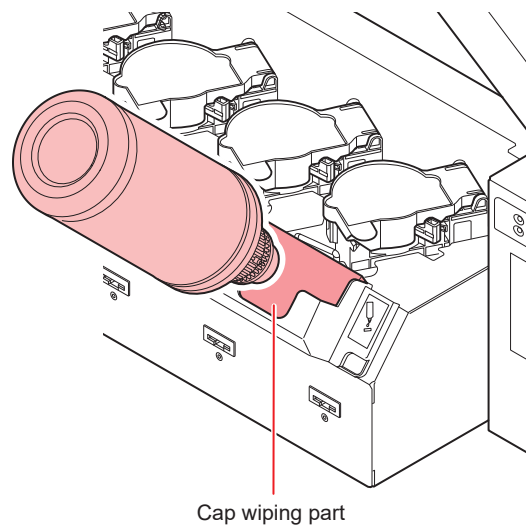

- 4** Keep the bottle in an upright position and remove any ink adhering to the cap surface by using a disposable wipe such as KimWipe.

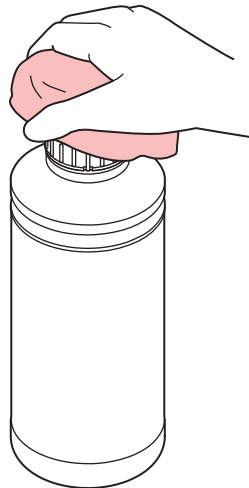

- 5** Remove the cap from the used ink bottle.

- If the cap is hard to remove, use the fastening jig to remove it.

- 6** Set a new ink bottle.

-  ["Setting Ink Bottles"\(P. 38\)](#)



- Do not leave the ink bottle with the specialized cap attached in a location where it is exposed to light for a long period of time. Doing so may cause the ink inside the bottle to harden.



- Check for dust or debris on the cap before setting the bottle. If any paper or dust adheres to the cap, it may cause a clogged path deflection.
-

● **When [INK NEAR END] is displayed**

It indicates that only a small amount of ink is remaining. Even though you can continue to print in this condition, note that the ink may finish completely before you finish your printing job. We recommend that you replace the ink bottles as soon as possible.

When the [ENTER] key is pressed in LOCAL, the bottle to be replaced can be checked from the local guidance.  ["Displaying other information"\(P. 112\)](#)

If the light-blocking cover comes off

When the light-blocking cover comes off, light penetrating into the tank may cause the ink to harden. Perform the following steps to reattach the light-blocking cover:

- 1 Insert the light-blocking cover (one nub) into the cover insertion hole on the tank.

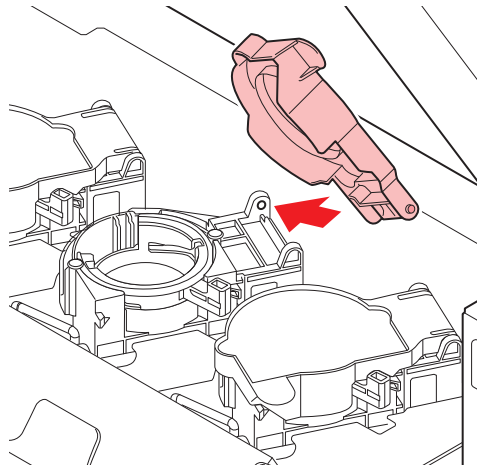

- 2 While pressing the cover into the cap insertion hole as explained in Step 1, insert the other nub into the other insertion hole.

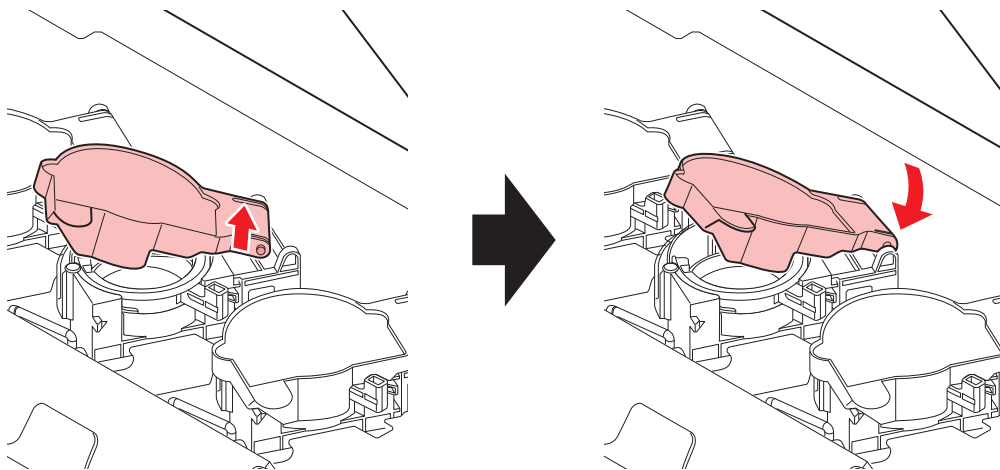

Ink Bottle Lamps

You can check the status of the ink bottles set over the tank by looking at the lamp on the top of the ink bottle.

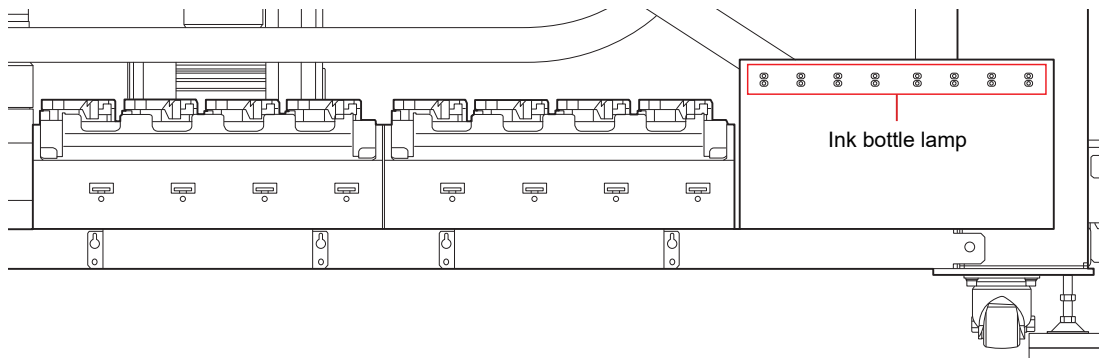

Ink bottle lamp status	Description
Off	No error
Blinks in red	Only a small amount of ink is remaining (near end) or the ink is one month past its expiration date. It needs to be replaced soon.
Lights in red	Ink bottle cannot be used either because it is empty or because of some ink error. Ink bottle error
Rapidly blinks in red	Two months have passed since the expiration date so this ink bottle can't be used.
Lights in green	Indicates that the ink is being supplied. When using a 4-color ink set, this machine supplies the ink from the ink bottle having the nearest ink expiration date.
Blinks in red and green alternately	This occurs when the green lamp is lit and the red lamp is flashing at the same time.

Restrictions Regarding the Use of Ink

The ink expiration date is indicated on the ink bottle.

Expired ink may cause ejection failures or alter the color tone.

Printing is possible even if the ink has passed its expiration date. Nevertheless, we recommend replacing with new ink or using up as quickly as possible

Example) When the expiration date is April, 2020

May: Replace with new ink or use up as quickly as possible. Printing is possible.

June: Replace with new ink or use up as quickly as possible. Printing is possible.

July: Replace with new ink. Printing will be unavailable soon.



- The message appears on the display.

Ink End and Ink Near End

The ink near end notification is provided by the ink bottle lamp blinking in red. It is recommended to replace the ink bottle as soon as possible.

The ink end notification is provided by the ink bottle lamp lit in red. The ink bottle needs to be replaced immediately.

Storage of Ink Bottles

Pay attention to the following points when storing ink bottles.

- Store in a place with low humidity and no direct sunlight.
- Do not drop or smash the ink bottle.
- Avoid contamination or electrostatic discharge of the Ink IC chip.

- Always store the ink bottle and Ink IC chip together.



Ink bottle and ink IC chip

Precautions on Handling Ink Bottles



- If the ink gets in your eyes, immediately hold your eyes under clean, running water for at least 15 minutes to rinse away ink completely from your eyes and eyelids. Seek medical advice as soon as possible.
- Store the ink bottles in a place not more than 1 m off the ground. This is because if an ink bottle stored in a place higher than 1 m falls, its bottle cap may come off, spilling the ink.
- Keep the ink bottle out of reach of children.
- Use genuine ink bottles for this machine. This machine functions upon recognizing the genuine ink bottles. We provide no guarantee against machinery failure caused by altered ink bottles or similar reasons, even during the guarantee period.
- If an ink bottle is moved from a cold to warm place, keep it at room temperature for at least 3 hours before use.
- Store the ink bottles in a cool place.
- Request an industrial waste processor to process the empty ink bottles.
- Use all the ink from the bottle within three months of opening. Note that the print quality deteriorates if the ink is used for too long after opening.



- Do not shake the ink bottle too vigorously. Vigorous shaking may cause the ink to leak from the bottle.
- Never refill an ink bottle. This may cause malfunction. Mimaki bears no responsibility for problems caused by such refilling.
- Do not touch or stain the IC chip circuit contacts. This may cause malfunction of the circuit board.



- The ink bottle installed in the device may become dented as shown in the figure. This is normal, and does not affect the use or operation of this machine.

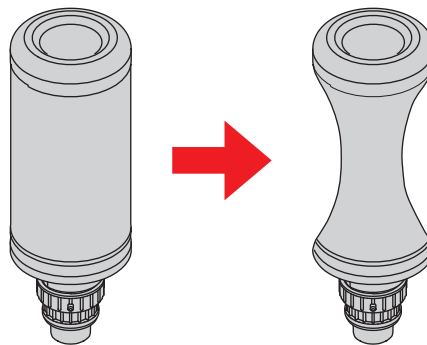

1.7 Media

Usable media sizes and notes for handling are described below.

Usable media sizes

Item name	JFX200-2513EX
Maximum width	2500mm
Maximum length	1300mm
Maximum print width	2500mm
Thickness	50mm or less
Weight ^{*1}	162kg or less

*1. Roughly 50 kg per 1 m².

Storing Media

Store the media in a dust-proof place with no direct sunlight. Also, avoid storing the media in hot or highly humid places.

Precautions when handling media

Note the following precautions on handling the media.

● Media elasticity

Do not use the media in the sheet form immediately after opening the package. Media may expand or shrink depending on the temperature and humidity of the room. After opening the package, the media must be exposed to the atmosphere in which it will be used, for at least 30 minutes.

● Warping of the media

When using tabular media, use the ones that are flat, bent back with respect to the upward facing printed surface (raised in the center). Media bent in an upward direction may not adhere to the table. The media prone to bending should be stored on a platform or on a palette one size smaller than the media to ensure that it bends downward. Also, make sure that there are no bends in the media protruding out from the suction area.

● Attaching the media

To maintain the suction effect, cover the suction holes on the table not covered by the media with any other media that is thinner than the media in use.

● Other precautions

- Do not keep anything on the surface of the coated paper. Certain types of coated paper may undergo discoloration.
- Curled media that cannot adhere firmly to the table and the media that gets misaligned when the Y-bar is moved cannot be used. Before printing, secure the media to the table by using material such as a tape.
- Refrain from using the media that bends or gets deformed even when the LOGICAL SEEK setting is "OFF".

- As the board surface is made of multiple boards, the board joints may get reflected in the printed image depending on the media thickness or strength of the paper. Also, vacuum holes may affect the printed images in the same way. Take a test print before the actual printing, to ensure a smooth printing process.

1.8 Notes Regarding Work Environment, etc.

The frequency of configuring print settings and conducting maintenance is largely influenced by the work environment in which printing is performed and the conditions of the used media. Make sure that you have completely understood the following items before using this machine.

- **If there is a lot of dust or dirt in the work environment**
 - To keep the nozzle surface clean, perform interval wiping after about every 1500 mm of printing.
☞ "Setting Nozzle Surface Cleaning Frequency"(P. 94)
 - Change the settings of interval wiping according to the amount of dust or dirt.
- **When the head gap value is set to large due to reasons such as fibers protruding from the media**
- **When media that can easily reflect UV light, such as glass or glossy metal is used**
 - UV light may get exposed onto the nozzle due to frequent mist scattering. Increase the REFRESH level during plotting, then set interval wiping.
☞ "Other Settings"(P. 95)
☞ "Setting Nozzle Surface Cleaning Frequency"(P. 94)
 - Increase the frequency of all types of maintenance.
- **In case of low usage ink (print head)**
 - Ink discharge of less used print heads tends to become unstable as compared to other print heads. Increase the REFRESH level during plotting, then keep the head usage rate above certain value.
☞ "Other Settings"(P. 95)
- **When printing on media that is prone to electrostatic charge**
- **When printing in an environment with low humidity (in winters, etc.)**
 - Take thorough measures against electrostatic charging with the help of humidifier, etc. Static electricity attracts mist and dust around the printing area and the head. Set interval wiping if printing is to be continued for a long time.
☞ "Setting Nozzle Surface Cleaning Frequency"(P. 94)
- **When printing on uneven media (three-dimensional medium)**
 - To keep the head gap as constant as possible, set unnecessary media, etc. even at locations other than the location inside the suction area where the printing media is set. If deterioration of the head due to reflected light is neglected for a long period of time, it may cause malfunction to the point where the head may have to be replaced.

Chapter 2 Basic Usage



This chapter

This chapter explains how to prepare ink/media for printing and the procedures and configuration to be done before printing.

Operation flow	52	Test printing.....	62
Turning the Power On/Off	53	Examples of Plotting Failure	62
Turning the power on	53	Relation between the head layout and the	
Turning off the power	53	test patterns	63
Setting up the Media	55	Taking a Test Print.....	64
Setting up the Media	55	Head Cleaning.....	66
Move the illumination position of the UV-LED .	58	Printing the Data.....	68
Position of the UV-LED unit	58	Starting a Printing Operation.....	68
		Aborting a Printing Operation.....	69
		Deleting the Received Data (Data Clear)....	69
		Moving the Y-bar.....	69

2.1 Operation flow

1. Turn power On/Off

 ["Turning the Power On/Off"\(P. 53\)](#)

2. Set up the Media

 ["Setting up the Media"\(P. 55\)](#)

3. Move the illumination position of the UV lamp

Move the illumination position of the UV lamp

4. Test printing

 ["Test printing"\(P. 62\)](#)

5. Head cleaning

 ["Head Cleaning"\(P. 66\)](#)

6. Print the data

 ["Printing the Data"\(P. 68\)](#)

2.2 Turning the Power On/Off

Turning the power on

1 Press the power button.

- Press the power button located on the left side of the operation panel.

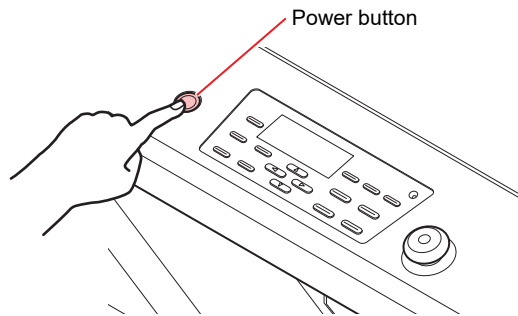

- When the power is turned on, the firmware version is displayed.

JFX200EX Start-up
Ver 1.00

- Initialize the printer.

2 The machine enters the LOCAL mode.

<LOCAL>

3 Turn on the power of the connected PC.



- You should normally leave the machine power cord plugged into the power outlet. Keeping the power cord unplugged may clog the head nozzle. Depending on the symptoms, it might be difficult to remedy the fault.

Turning off the power

Once you have finished using the printer, press the power button located at the front side of this machine to turn the power off.

Before turning off the power, check if:

- Data is being received from the PC and if any data is still to be output.
- The head has returned to the capping station.
- Any error has occurred.
Error message

1 Turn off the power of the connected PC.

2 Press the power button to turn off the power.

- The power button lamp goes off.
- When using this machine again, press the power button and wait until the green lamp is lit.

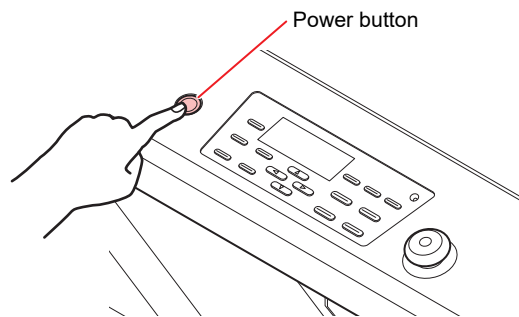

Precautions on turning off the power

- **Do not pull out the power cord from the power outlet.**

If the power cord is left plugged in, the power turns on periodically to run the nozzle clog prevention function (flushing function) and pressure regulation function.

On the other hand, if the power cord is removed from the plug, the automatic maintenance functions such as flushing do not run, causing nozzle clogs.

- **Check the head position and turn off the power.**

If the power is turned off before the head returns to the capping station, the head may dry out and clog the nozzle.

At this time, turn the power back on and make sure the head returns to the capping station before turning off the power.

- **Do not turn off the power during printing.**

The head may not return to the capping station.

- **Turn OFF the main power, and then unplug the cable.**

When turning off the power for reasons such as moving this machine to a different place or fixing a machine error, press the power button on the operation panel and make sure that the lamp is turned off before removing the power cable from the outlet.

- **The power does not turn off even when the stop switch is pressed.**

Press this switch when you need to stop this machine. Note that the power is not turned OFF even if you press the stop switch.

2.3 Setting up the Media

This machine can be used with a leaf media.

For usable media, see "Usable media sizes"(P. 48) .

Setting up the Media

Important!

- If a suction hole within the suction area is not covered by the media, lay out a thin sheet material such as paper, film or tape to cover the hole.
- Media peripheral parts may bend back due to heat. Use an accessory such as an adhesive tape to help secure it in place.
- The table edges (both top and bottom) are provided with guide holes for inserting the layout pins provided with the printer. Use these guide holes to keep the media straight.
 "Media Guide Holes"(P. 57)

1 Switch the suction valve of the front surface of the table according to the size of the inserted media.

- The valve is open when the handle is horizontal and close when it is vertical.

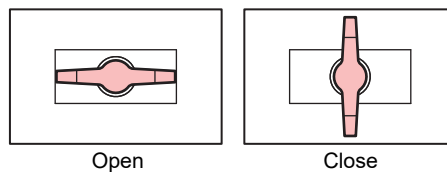

2 Press the [VACUUM] key to turn on the VACUUM lamp and adsorb the media.

- For details about the suction area, see "Suction Area"(P. 56).

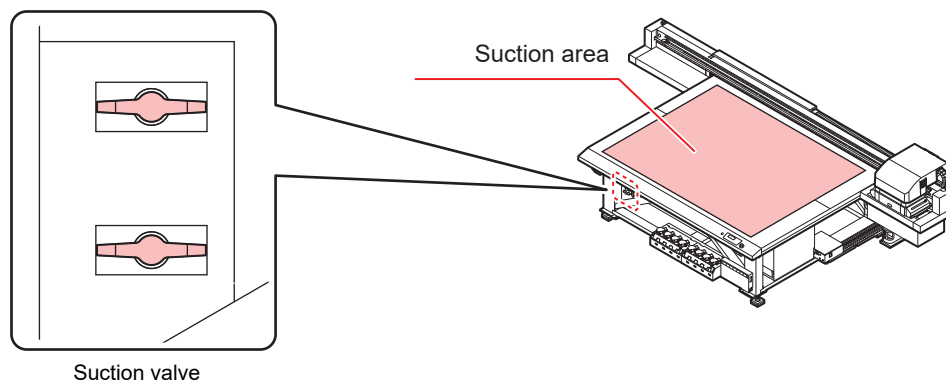

● After setting up the media, perform the following settings:

- "Registering the Media Thickness"(P. 74)
- "HEAD GAP Value"(P. 77)



- Do not drop heavy media on the table as the table may get deformed due to its weight. Also, do not concentrate the weight at one spot (up to 50 kg/m²)
 "Machine specifications"(P. 184)

Suction Area

The following figure shows the suction area.

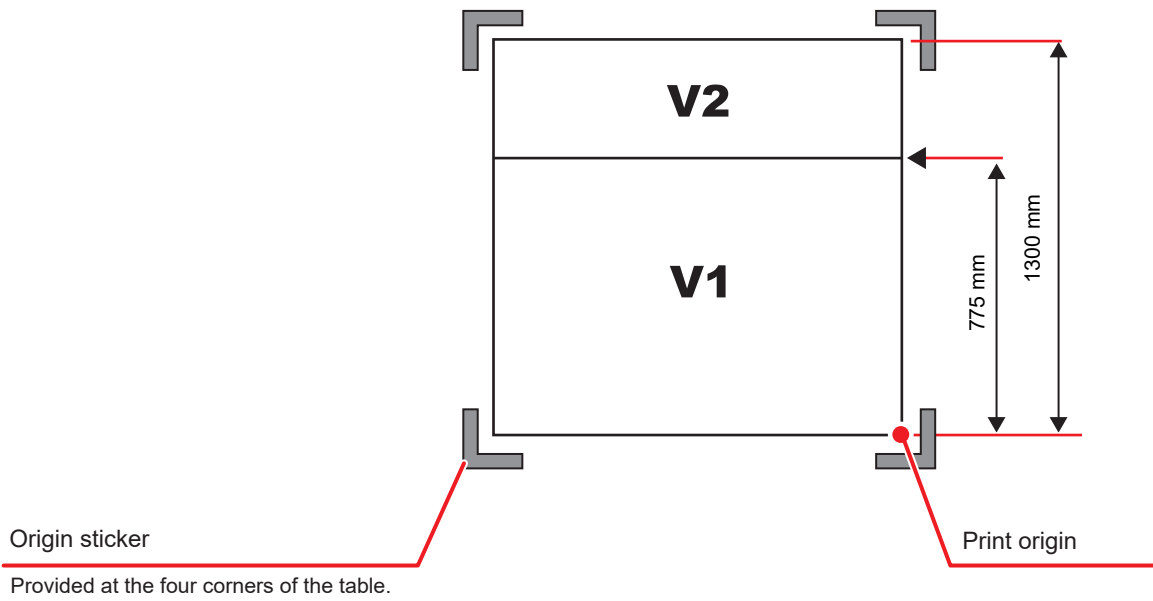

- To change the point of origin, see ["Changing the Point of Origin"\(P. 72\)](#).

Media Guide Holes

The table edges (both top and bottom) are provided with guide holes for inserting the layout pins provided with the printer. Use these guide holes to keep the media straight.



- A commercially available M3 screw can be used instead of the positioning pin provided with the printer. In that case, screws can be used to secure the media to both the left and front sides of the table.



- When using the provided layout pin, the media, the media thickness of 5 mm or less cannot be used.
- When printing on a media having a thickness of 5 mm or less, make sure that the layout pin has been removed from the top of the table.

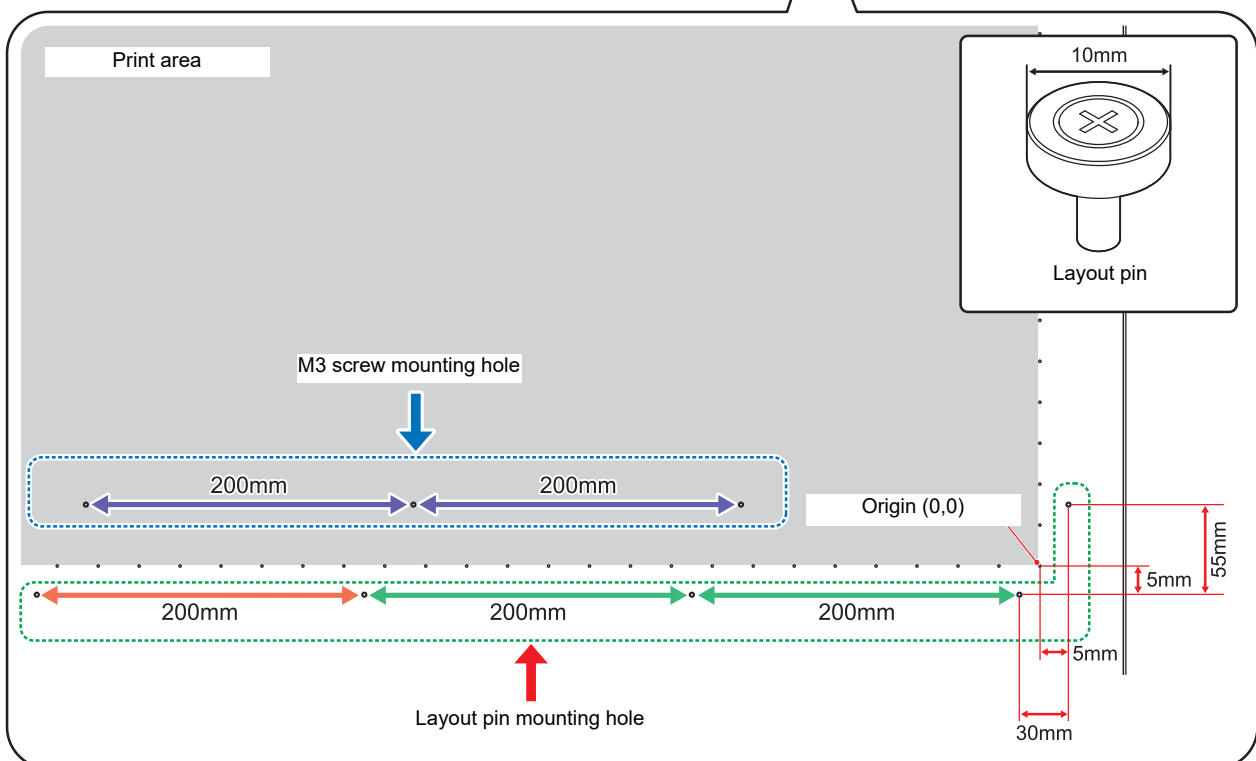
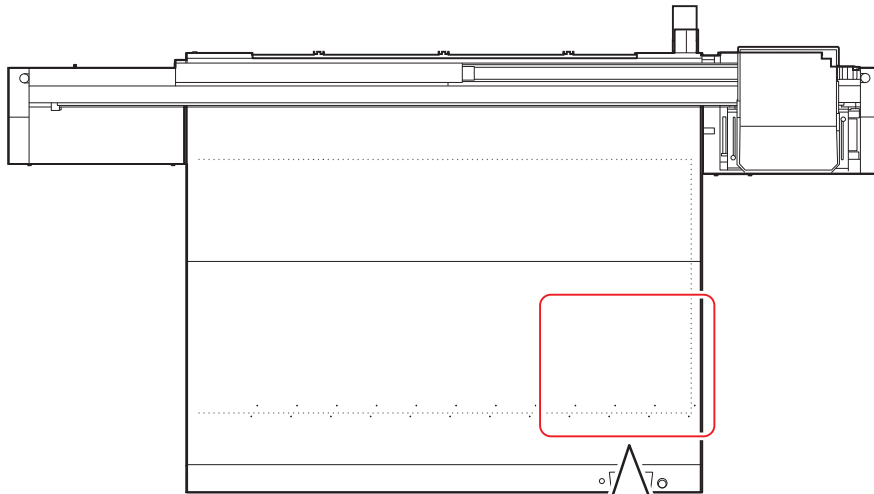

2.4 Move the illumination position of the UV-LED

According to the color to be printed and the spot color, loosen the screws on both sides of the carriage and slide the lamp to change its position.



- Make sure that there is no foreign matter in the groove provided for moving the UV lamp on both sides of the carriage. Any metal items such as screws that may have fallen in the groove can catch fire.

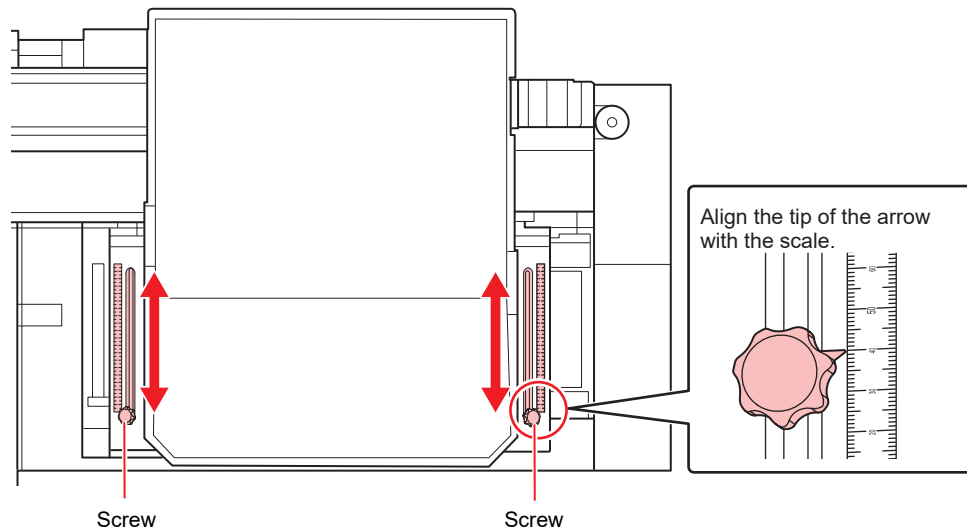

Position of the UV-LED unit

This machine can print "2-layer print" and "3-layer print" for each layer using colors and spot colors.

The following are recommended positions for the UV-LED unit. If it is not possible to change the lamp position during printing, then set the lamp position to 0 mm before printing.











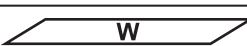
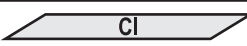

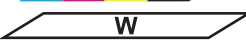

- If you change the position of the UV-LED unit during printing with RasterLink, an alert will be displayed on RasterLink.

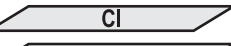
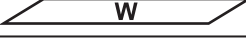
● 4-color, W

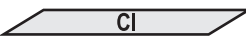









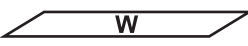
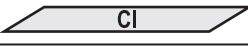



Printing method	Ink layer	UV-LED position (mm)
Single layer		120
		65
2-layer	2-layer : 1-layer :	65
	2-layer : 1-layer :	190

● **4-color, W,CL (When using LUS-150, LH-100, LUS-120, or LUS-350)**



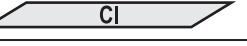























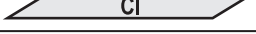

Printing method	Ink layer	UV-LED position (mm)
Single layer		120
		65
		0
2-layer	2-layer :  1-layer : 	65
	2-layer :  1-layer : 	190
	2-layer :  1-layer : 	0
	2-layer :  1-layer : 	2-layer : 0 1-layer : 65
	2-layer :  1-layer : 	190
3-layer	3-layer :  2-layer :  1-layer : 	3-layer : 0 1,2-layer : 65

● **4-color, W,CL (When using LUS-211)**

















When the ink type is LUS-211, the recommended UV-LED position differs for each layer print and resolution. Change the position of the UV-LED as shown in the table below.

Printing method	Ink layer	UV-LED position (mm)		
		Resolution (dpi) 300×300 300×450 600×600	Resolution (dpi) 600×900	Resolution (dpi) 1200×1200
Single layer		120	120	120
		65	65	65
		0	0	0
2-layer	2-layer :  1-layer : 	190	65	65
	2-layer :  1-layer : 	0	0	65
	2-layer :  1-layer : 	0	0	0
	2-layer :  1-layer : 	2-layer : 0 1-layer : 65	2-layer : 0 1-layer : 65	2-layer : 0 1-layer : 65
	2-layer :  1-layer : 	190	190	190
3-layer	3-layer :  2-layer :  1-layer : 	3-layer : 0 1,2-layer : 190	3-layer : 0 1,2-layer : 65	3-layer : 0 1,2-layer : 65

● 4-color, W, CL, Pr

Printing method	Ink layer	UV-LED position (mm)
Single layer		120
		65
		0
		0
2-layer	2-layer :  1-layer : 	65
	2-layer :  1-layer : 	190
	2-layer :  1-layer : 	0
	2-layer :  1-layer : 	2-layer : 0 1-layer : 65
	2-layer :  1-layer : 	65
	2-layer :  1-layer : 	2-layer : 65 1-layer : 0
	2-layer :  1-layer : 	0
	2-layer :  1-layer : 	190
3-layer	3-layer :  2-layer :  1-layer : 	3-layer : 0 1,2-layer : 65
	3-layer :  2-layer :  1-layer : 	0
	3-layer :  2-layer :  1-layer : 	2,3-layer : 65 1-layer : 0

● 6-color, W, CL

Printing method	Ink layer	UV-LED position (mm)
Single layer		120
		65
		0
2-layer	2-layer :  1-layer : 	65
	2-layer :  1-layer : 	190
	2-layer :  1-layer : 	0
	2-layer :  1-layer : 	2-layer : 0 1-layer : 65
	2-layer :  1-layer : 	190
3-layer	3-layer :  2-layer :  1-layer : 	3-layer : 0 1,2-layer : 65

2.5 Test printing

Print the test pattern to make sure that there are no ink discharge problems such as clogged nozzle (blurred print or missing nozzles).

Examples of Plotting Failure

Discharge failure of the head (head nozzle) due to dust is a typical example of plotting failure.

Periodically check the condition of the nozzle before output or during output to avoid using it in defective state.

The condition of the nozzle can be checked by [TEST PRINT] of this machine.

☞ "Test printing"(P. 62)

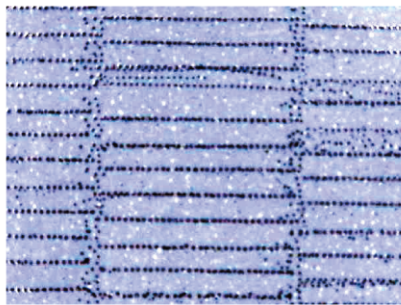

Deflection

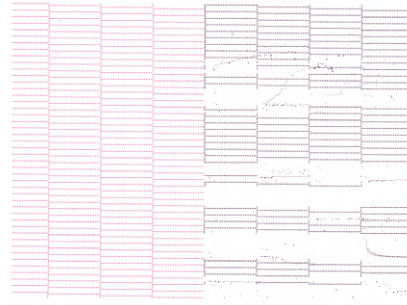

Nozzle clogging



Ink drooping



Satellite

Relation between the head layout and the test patterns

The following figure shows the relation between head layout and the positions of the printed test pattern.

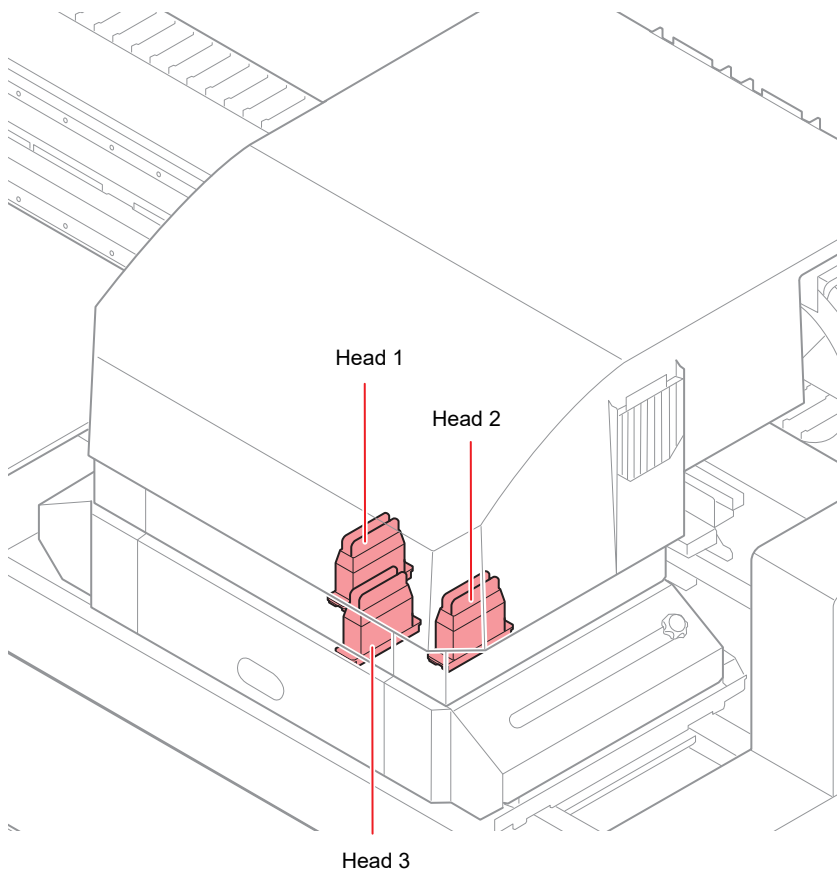

• 4C + 4SP

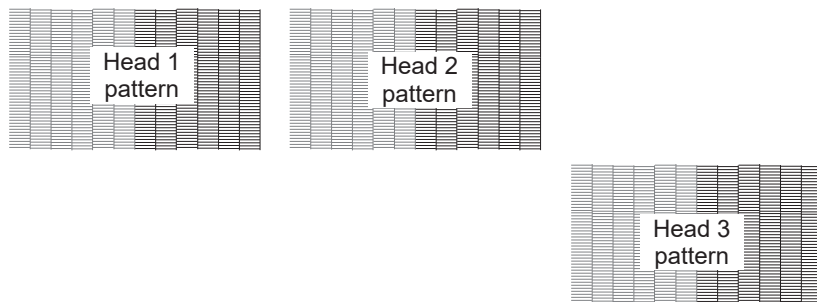

• 6C + 4SP

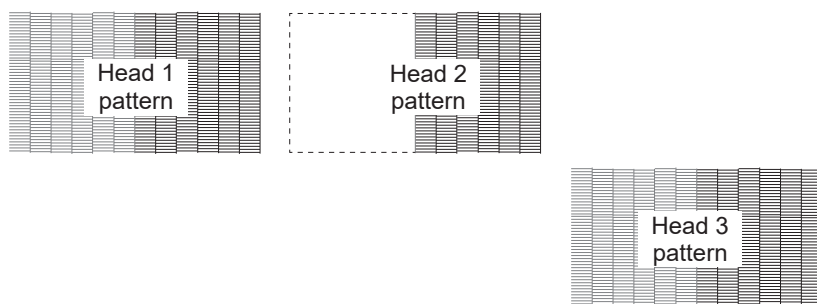

Taking a Test Print

Print the test pattern to make sure that there are no ink discharge problems such as clogged nozzle (blurred print or missing nozzles).

The test pattern alignment direction can be selected for each test printing from the following two types. Select the direction suitable for your printing job.

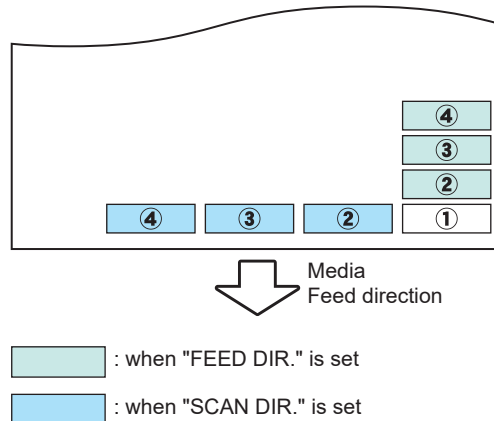

Before running the test print, confirm that:

- The media is set up
☞ "Setting up the Media"(P. 55)
- The point of origin is set up
☞ "Changing the Point of Origin"(P. 72)
- The head gap is adjusted
☞ "HEAD GAP Value"(P. 77)

1 Press the [TEST] key in LOCAL.

- Press the ▲▼ key to change the test pattern alignment direction.

TEST PRINT
(FEED DIR.) [ENT]

2 Press the [ENTER] key.

3 Press the ▲▼ key to select "ON" or "OFF" for [NOZZLE RECOVERY].

- ON:
Print the pattern upon performing nozzle recovery of the missing nozzles that have been registered in [NOZZLE RECOVERY] under MAINTENANCE function with the good nozzles
- OFF:
Print the pattern without NOZZLE RECOVERY even if there are problems such as missing nozzles

TEST PRINT
NOZZLE RECOVERY : ON

Important!

- If the MAINTENANCE function [NOZZLE RECOVERY] is not registered or if the [NOZZLE RECOVERY] [CONFIRM MENU] is turned "OFF", the operations in this step cannot be set.

4 Press the [ENTER] key.

- Start the test print.

PRINT
PLEASE WAIT

- Once the printing is completed, the display returns to the Step 1.

TEST PRINT
(FEED DIR.) [ENT]

5 Check the print results.

- Under normal circumstances, the operations end here.
- In the case of abnormality, perform head cleaning.

 ["Head Cleaning"\(P. 66\)](#)

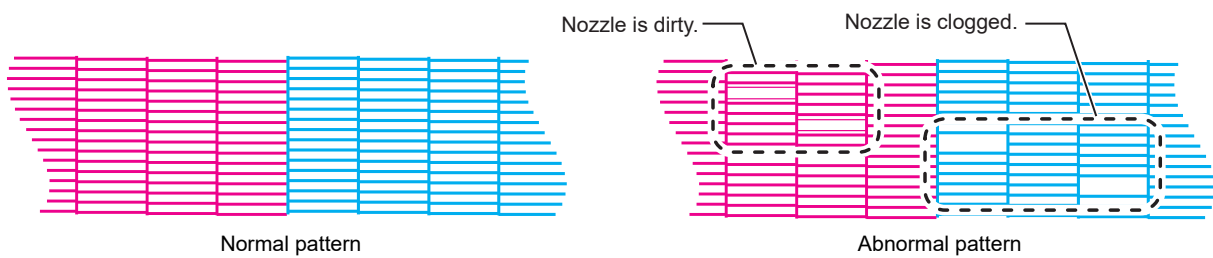

2.6 Head Cleaning

Check the printed test pattern results and perform cleaning depending on the symptoms. Head cleaning can be done in three ways. Use them based on the pattern print results.

1 Press the [CLEANING] key in LOCAL mode.

```
CLEANING
SOFT           [ENT]
```

2 Press ▲ ▼ to select a cleaning type.

- SOFT:
When lines are bent or missing
- NORMAL:
When one or more lines are missing or are composed of mixed colors
- HARD:
When poor image quality cannot be corrected even if cleaning is performed in NORMAL or SOFT mode

```
CLEANING
NORMAL        [ENT]
```

3 Press the [ENTER] key.

```
SELECT HEAD
: 1 2 3
```

4 Press ▲ ▼ to select the head for cleaning.

- Available settings:
1 2 3 (all the heads)
1 _ _ (head 1)
_ 2 _ (head 2)
_ _ 3 (head 3)

```
SELECT HEAD
: 1 _ _
```

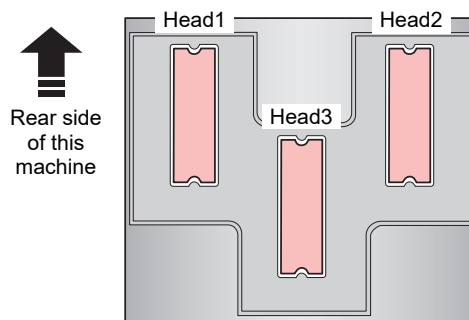



5 Press the [ENTER] key.

```
**CLEANING**
PLEASE WAIT
```

6 Run the test print again and check the print results.

- Repeat the cleaning and test printing until the print results are normal.

● If the image quality does not improve even after head cleaning

- Clean the wiper and ink cap.
 ["Cleaning wiper and cap"\(P. 120\)](#)
- Perform the nozzle recovery settings.
 ["When Nozzle Clogging Cannot Be Solved"\(P. 134\)](#)

2.7 Printing the Data

Starting a Printing Operation

1 Set the media.

- ☞ "Setting up the Media"(P. 55)
 - Open or close the suction valve according to the media size.
 - Press the [VACUUM] key to turn on the VACUUM lamp and adsorb the media.

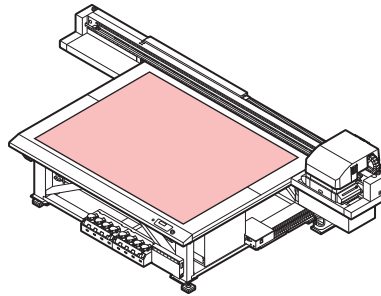

2 Press the [REMOTE] key in LOCAL.

- The screen changes to REMOTE mode and data can be received from the PC.

3 Send the data to be printed from the PC to the printer.

- View the printing conditions.
- For how to send the data, read the instruction manual of the output software.

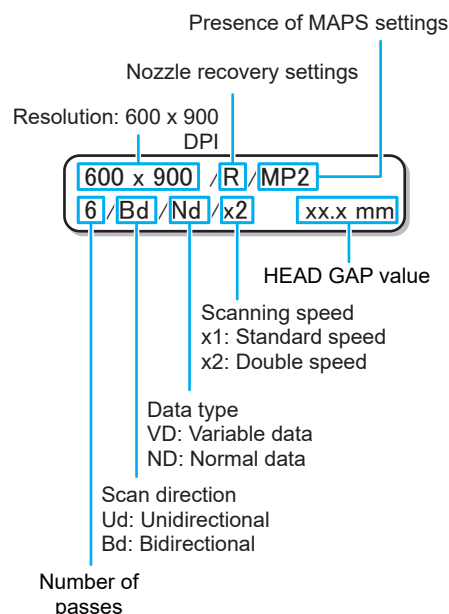

4 Remove the media after the completion of printing.

- Move the Y-bar outside the table.
 - ☞ "Moving the Y-bar"(P. 69)
- Press the [VACUUM] key to turn off suction.
- Take out the media.

(Important!)

- The media may get lifted and the print may get aborted due to the heat generated by the LED UV during printing.
Reset the new media and start printing.

Aborting a Printing Operation

To stop printing halfway through, perform the following operations:

1 Press the [REMOTE] key while printing.

- The printing operation stops.
- Stop any data transfer from the PC by interrupting the process from the PC.
- If you press the [REMOTE] key again, the printing operation restarts from the point at which the printing operation was aborted.

<LOCAL>
DATA REMAIN

Deleting the Received Data (Data Clear)

If you want to stop printing, delete the already received data.

1 Press the [DATA CLEAR] key in LOCAL.

DATA CLEAR [ENT]

2 Press the [ENTER] key.

- Deletes the received data and returns to LOCAL mode.

DATA CLEAR

Moving the Y-bar

The Y-bar can be moved to check the print results or to perform similar operations.

Set the Y-bar retracting position (VIEW position) in advance.

Setting the VIEW Position

1 Press the [FUNCTION] key in LOCAL.

FUNCTION
VIEW [ENT]

2 Press the [ENTER] key.

VIEW
MOVE START <ent>



3 Press the  key.

```
VIEW
SET VIEW POS
```

4 Press the [ENTER] key.

```
SET VIEW POS
=          **** mm
```

5 By pressing the   keys, set the position to which the Y-bar is to be moved.

-  key: The Y-bar moves to the backside of the table with the point of origin in the center.
-  key: The Y-bar moves to the front side of the table with the point of origin in the center.

```
SET VIEW POS
=          500 mm
```

6 Press the [ENTER] key.

- The value is set and the display returns to Step 2.

```
** MOVING NOW **
PLEASE WAIT
```

Moving the Y-bar to VIEW position

1 Press the [FUNCTION] key in LOCAL.

```
FUNCTION
VIEW          [ENT]
```

2 Press the [ENTER] key.

```
VIEW
MOVE START   <ent>
```

3 Press the [ENTER] key.

- Y-bar moves.

```
** MOVING NOW **
PLEASE WAIT
```

Chapter 3 Convenient Usage



This chapter

This chapter explains the operation procedures and various settings for convenient use of this machine.

Changing the Point of Origin	72	Ionizer Settings.....	91
Using JOG Keys to Change the Print Origin	72	AUTO CLEANING Settings	92
Using FUNCTION menu to Change the Print Origin.....	73	Setting Nozzle Surface Cleaning Frequency...94	
Registering the Media Thickness	74	Other Settings	95
Registering the Media Thickness Manually 74		Machine Settings.....	96
Registering the Media Thickness with the [UP] and [DOWN] Keys.....	74	AUTO Power-off Settings.....	97
Automatic Checking of the Media Thickness	75	Time Settings	97
HEAD GAP Value.....	77	Unit Settings.....	98
Registering the Head Gap Value	77	Key Buzzer Settings.....	99
Checking the Head Gap Value.....	78	Language Settings	100
List of Functions	79	Network Settings.....	101
Adjusting the Bidirectional Print Drop Position	80	External Stop I/F	102
Correcting the Drop Position	80	Nozzle Check Menu	104
Setting LOGICAL SEEK	82	Nozzle Check Menu List	104
Setting UV LEVEL	84	Printing Nozzle Check Flow	104
Reducing Stripes Between Passes	86	Print Operations During "Nozzle Missing" Judgment and Error Occurrence.....	105
MAPS Function	86	Printing Nozzle Check Settings.....	105
Setting the MAPS2 function (4 color + special colored ink).....	86	Auto Nozzle Recovery Settings	107
WORK CHANGE Settings.....	90	Judgment Condition Settings	107
		Resetting to Default Settings.....	109
		Confirming Machine Information	110
		Checking Machine Usage Status	110
		Checking Version Information.....	111
		Displaying other information	112

3.1 Changing the Point of Origin

The factory setting of point of origin can be changed.

It can be changed in one of the two ways.

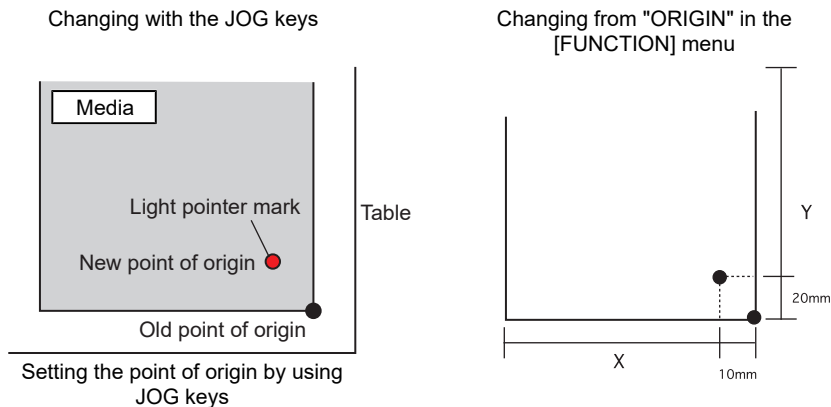

Using JOG Keys to Change the Print Origin

1 Press ▲ ▼ ◀ ▶ in LOCAL.

- The screen changes to [ORIGIN SETUP].
- A red "• (light pointer mark)" appears on the table or media.



2 Press ▲ ▼ ◀ ▶ to move the light pointer mark.

- Move the light pointer mark to the position set as the new origin.

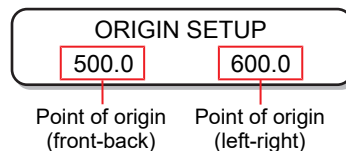

3 Once the print origin has been determined, press the [ENTER] key.

- The origin has changed.



- The origin set by using the JOG keys is cleared when the power is turned off.

Using FUNCTION menu to Change the Print Origin

When setting an exact origin, set the X and Y coordinates of the origin from the FUNCTION menu.

When the origin is set by using this option, the set value becomes the point of origin (0.0).

1 Press the [FUNCTION] key in LOCAL.

FUNCTION	
VIEW	[ENT]

2 Press \blacktriangle \blacktriangledown and select [ORIGIN], and press the [ENTER] key twice.

- The screen changes to the X-axis offset value setup screen.

ORIGIN	1300 mm
X OFFS:	1200 mm

3 Press \blacktriangle \blacktriangledown to enter the numerical value.

- Set X-axis origin.

ORIGIN	1300 mm
X OFFS:	1290 mm

4 Press the [ENTER] key.

ORIGIN	
SELECT: X OFFSET	

5 Press \blacktriangle \blacktriangledown to select the [Y offset], and press the [ENTER] key.

ORIGIN	
SELECT: Y OFFSET	

6 Press \blacktriangle \blacktriangledown to enter the numerical value.

- Set Y-axis origin.

ORIGIN	2500 mm
Y OFFSET:	2090 mm

7 Press the [ENTER] key.

ORIGIN	
SELECT: Y OFFSET	

8 Press the [END] key several times to end the operation.

Important!

- The set origin is not cleared even when the power is turned off.

3.2 Registering the Media Thickness

Register the thickness of the media to be set.

You can register the thickness in the following three methods.

- Registering the thickness manually
- Selecting with [UP] [DOWN] keys
- Checking the thickness automatically

Registering the Media Thickness Manually

- 1 Press the [FUNCTION] key in LOCAL.



```
FUNCTION
VIEW [ENT]
```

- 2 Press   to select the [HEAD HEIGHT].

```
FUNCTION
HEAD HEIGHT [ENT]
```

- 3 Press the [ENTER] key twice.

```
MEDIA THICKNESS
2.5mm
```

- 4 Press   to enter the media thickness (0.0 to 50.0 mm).

```
MEDIA THICKNESS
10.5mm
```

- 5 Press the [ENTER] key.

```
FUNCTION
HEAD HEIGHT [ENT]
```

- 6 Press the [END] key to end the operation.

Registering the Media Thickness with the [UP] and [DOWN] Keys

- 1 Press the [UP] key or [DOWN] key.

```
ORIGIN SETUP
Z HEIGHT = 45.0
```

- 2 Press the [UP] key or [DOWN] key to adjust the value of thickness.

```
ORIGIN SETUP
Z HEIGHT = 50.0
```

3 Press the [ENTER] key.

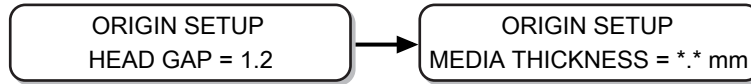

Automatic Checking of the Media Thickness

Media thickness is automatically checked by the gap pin located at the center of the carriage.

1 Set the media.



- Be sure to set the media within the print range. If automatic thickness check is conducted without inserting the media, the print heads may get damaged.

2 Press the [FUNCTION] key in LOCAL.

FUNCTION
VIEW [ENT]

3 Press ▲ ▼ to select the [HEAD HEIGHT].

FUNCTION
HEAD HEIGHT [ENT]

4 Press the [ENTER] key.

HEAD HEIGHT
MEDIA THICKNESS [ENT]

5 Press ▲ ▼ to select the [THICKNESS CHECK].

HEAD HEIGHT
THICKNESS CHECK [ENT]

6 Press the [ENTER] key.

- To prepare the machine for the thickness check, the Y-bar is raised to the highest point.
- The carriage moves inside the print area.

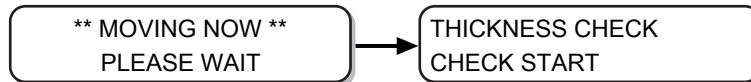

7 Press the [ENTER] key.

- The media thickness is checked automatically.
- The checked thickness is displayed.
- The carriage returns to the retracted position, and the display returns to Step 5.

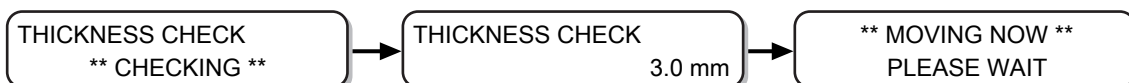

8 Press the [END] key several times to end the operation.



- Tolerance of the automatic thickness check is ± 0.1 mm.
-

3.3 HEAD GAP Value

Set the head gap (height from media to head nozzle surface).

When the head is to be moved onto the table for operations such as printing or maintenance, it moves while keeping the head gap at the pre-set value.

The upper limit of head gap varies depending on the thickness of the media.

Available settings: [1.2 mm to 3.0 mm] (per 0.1 mm/default: 1.5 mm)

Registering the Head Gap Value

Perform the following operations when you want to register the currently set head gap value.

- 1 Press the [FUNCTION] key in LOCAL.

```
FUNCTION
VIEW [ENT]
```

- 2 Press \blacktriangle \blacktriangledown to select the [HEAD HEIGHT].

```
FUNCTION
HEAD HEIGHT [ENT]
```

- 3 Press the [ENTER] key.

```
HEAD HEIGHT
MEDIA THICKNESS [ENT]
```

- 4 Press \blacktriangle \blacktriangledown to select the [HEAD GAP].

```
SETUP
HEAD GAP [ENT]
```

- 5 Press the [ENTER] key.

```
HEAD GAP
= 2.0 mm
```

- 6 Press \blacktriangle \blacktriangledown to set the head gap value.

- Available settings: 1.2 to 3.0 mm

```
HEAD GAP
= 3.0 mm
```

- 7 Press the [ENTER] key.

```
SETUP
HEAD GAP [ENT]
```

- 8 To end the operation, press the [ENTER] key several times.



- An incorrect head gap value may deteriorate the print quality, due to large drops of ink dropped on the media in some cases or other such issues.

Checking the Head Gap Value

Perform the following operations when you want to check the currently set head gap value.

- 1** Press the [ENTER] key in LOCAL.
- 2** Press the [ENTER] key several times to display [HEAD GAP].
 - The currently set head gap value is displayed.

3.4 List of Functions

This section outlines the various functions and describes their settings.

Important! About default "HOST" function

- The value specified in the RIP software runs this function. When a value other than "HOST" is specified, the specified value is used instead of waiting for instructions from the RIP software.
- Note that some functions may not be available depending on the RIP software used. In such cases, the value "When there are no instructions from RIP".
- For how to specify values in the RIP software, see the RIP software guide.

Function name		Available settings *1	If there is no instruction from RIP *2	Outline	
DROP.POScorrect ☞ "Correcting the Drop Position"(P. 80)		-40.0 to <u>0.0</u> to 40.0	-	Adjusts the dot position in reversible printing.	
LOGICAL SEEK ☞ "Setting LOGICAL SEEK"(P. 82)		<u>HOST</u> /ON/ OFF	ON	Sets the scan movable area during printing.	
INK LAYERS ☞ "Other Settings"(P. 95)		<u>HOST</u> /1 to 9	1	Sets the number of layers in which ink is to be applied.	
UV LEVEL ☞ "Setting UV LEVEL"(P. 84)		<u>HOST</u> / MANUAL	MANUAL	Specifies the UV irradiation pattern during printing.	
REFRESH ☞ "Other Settings"(P. 95)		<u>HOST</u> /Lv.0 (long refresh interval) to 3 (short refresh interval)	Lv.3	Refreshes the ink heads during printing.	
MAPS ☞ "MAPS Function"(P. 86)		OFF/ <u>MAPS2</u>	-	Performs settings to reduce stripes between the passes.	
	MAPS2	AUTO	-		
		MANUAL	PATTERN (1 to 4)/ SMOOTHING LV. (AUTO/5 to 100%)		-
WORK CHANGE ☞ "WORK CHANGE Settings"(P. 90)		HOST/ON/ <u>OFF</u>	-	Sets the operations to complete the printing.	
IONIZER ☞ "Ionizer Settings"(P. 91)		<u>ON</u> /OFF	-	Sets an optional IONIZER.	
AUTO CLEANING ☞ "AUTO CLEANING Settings"(P. 92)			OFF/ <u>PAGE</u>	Sets up automatic head cleaning to be performed before or during printing.	
	PAGE	INTERVAL	1 to <u>3</u> to 1000		-
		TYPE	NORMAL/ <u>SOFT</u> /HARD		-
INTERVAL WIPING ☞ "Setting Nozzle Surface Cleaning Frequency"(P. 94)		ON/ <u>OFF</u>	-	Sets up the wiping operation performed during printing.	

*1. It is set to the underlined value at the time of purchase.

*2. This is the value used for printing when the value set in the machine is to be prioritized or if no value is set in the RIP software (host), even if the type registration of this machine is set to "HOST".

3.5 Adjusting the Bidirectional Print Drop Position

If you change the printing conditions (such as media thickness and head height), do the following to correct the ink drop position for bidirectional printing (Bi) to acquire the proper printing results:

Correcting the Drop Position

1 Set the media and set the print origin.

-  ["Setting up the Media"\(P. 55\)](#)

2 In LOCAL, press the [ADJUST] key twice.

DROP.POScorrect
[ENT]

3 Press the [ENTER] key.

DROP.POScorrect
: Y300 dpi

4 Press   to select the resolution.

- Available settings: Y300dpi/Y600dpi/Y1200dpi
- Make the correction for all the resolutions.

DROP.POScorrect
: Y600 dpi

5 Press the [ENTER] key.

DROP.POScorrect
PRINT START [ENT]

6 Press the [ENTER] key to start pattern print.

- The test pattern is printed. (They are called pattern 1, 2, 3... in the order in which they were printed)

PRINT
PLEASE WAIT

7 Press to correct the drop position from pattern 1 onwards.

- Corrected value: -40.0 to 40.0

PATTERN 1
= 0.0

- The position at which the outward feed line and the return feed line become one straight line is the correction value.
- If the compensation value is not between -40.0 and 40.0, adjust the height of the printing heads and then re-perform the operations from Step 2 onwards.

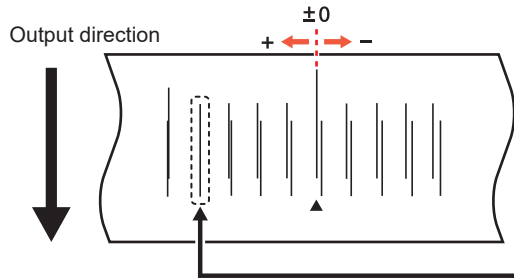

The outward feed line and the return feed line of the fourth pattern from 0 position in the positive direction form a straight line. Hence, in this case the drop position correction value is 4.0.

8 Press the [ENTER] key.

- Displays the next pattern input.
- Repeat Step 7.

9 Press the [END] key several times to end the operation.

Drop position correction without using the [ADJUST] key

The drop position can be corrected by using the [FUNCTION] key in LOCAL even without pressing the [ADJUST] key.

1 Press the [FUNCTION] key in LOCAL.

2 Press , select [SETUP] and press the [ENTER] key.

3 Press to select [DROP.POScorrect], and press the [ENTER] key.

- The operation is same as that when [ADJUST] key is pressed in LOCAL.

3.6 Setting LOGICAL SEEK

The head operations differ depending on the LOGICAL SEEK settings.

- Important!** • LOGICAL SEEK settings cannot be specified in RasterLink. When the machine setting is "HOST" the printing operation is performed considering that the LOGICAL SEEK is "ON".

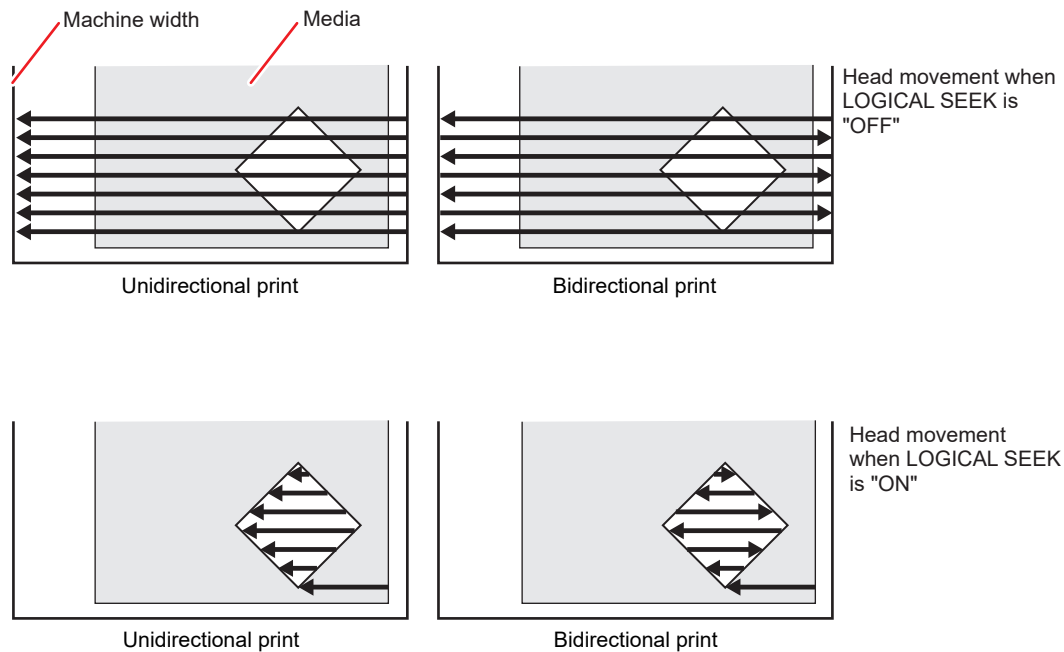

- 1 Press the [FUNCTION] key in LOCAL.

```
FUNCTION
VIEW [ENT]
```

- 2 Press ▲ ▼ to select [SETUP].

```
FUNCTION
SETUP [ENT]
```

- 3 Press the [ENTER] key.

```
SETUP
DROP.POScorrect [ENT]
```

- 4 Press ▲ ▼ to select [LOGICAL SEEK].

```
SETUP
LOGICAL SEEK [ENT]
```

- 5 Press the [ENTER] key.

```
LOGICAL SEEK
: HOST
```

6 Press ▲ ▼ to select the value to be set.

- Available settings: HOST/ON/OFF

```
LOGICAL SEEK  
: ON
```

7 Press the [ENTER] key.

```
SETUP  
LOGICAL SEEK [ENT]
```

8 Press the [END] key several times to end the operation.

3.7 Setting UV LEVEL

Set the UV LED irradiation pattern to be used and illumination intensity to be maintained during printing.

- 1** Press the [FUNCTION] key in LOCAL.

```
FUNCTION
VIEW [ENT]
```

- 2** Press ▲ ▼ to select [SETUP], and press the [ENTER] key.

```
SETUP
DROP.POScorrect [ENT]
```

- 3** Press ▲ ▼ to select [UV LEVEL].

```
SETUP
UV LEVEL [ENT]
```

- 4** Press the [ENTER] key.

```
UV LEVEL
: HOST
```

- 5** Press ▲ ▼ to select the value to be set.

```
UV LEVEL
: MANUAL
```

- **HOST:**
If this value is set, then both the UV irradiation pattern and UV illumination intensity specified in the application are used for irradiation.
- **MANUAL:**
If this value is set, then both the specified pattern and the UV illumination intensity are used for irradiation.

- 6** Press the [ENTER] key.

- If you have selected "HOST" in Step 5, then proceed to Step 7. However, if you have selected "MANUAL" in Step 5, then proceed to Step 8.

- 7** Press ▲ ▼ to adjust the illumination intensity (amount of light), and press the [ENTER] key.

```
UV LEVEL
LIGHT ADJUST 0%
```

- 8** Press ▲ ▼ to select the ink type to be set, and press the [ENTER] key.

- Available settings:
Color/White/ClearInk

```
UV LEVEL
: Colored
```

9 Press ▲ ▼ to select the scanning direction, and press the [ENTER] key.

- Available settings: Bi (bidirectional)/Uni (unidirectional)

UV LEVEL
: Bi

10 Press ▲ ▼ to select the printing pattern, and press the [ENTER] key.

- Available settings:
PATTERN 1, 2, and onwards/NO PRINT
- If you select "NO PRINT" then the UV lamp lights without printing anything, even if print data is sent.

UV LEVEL
: PATTERN 1

11 Press ▲ ▼ to select the irradiation level, and press the [ENTER] key.

- Available settings:
Level 0 to 15 (the higher the number, the more is the irradiation intensity.)

UV LEVEL
LEVEL: 10

12 Press the [END] key several times to end the operation.

3.8 Reducing Stripes Between Passes

MAPS Function

If the feed lines do not disappear even after performing media feed correction, use the MAPS (Mimaki Advanced PassSystem) function to disperse the pass boundary to make the feed lines less visible.

With this machine, you can use the MAPS2 function.



- When MAPS function is enabled, the hues may be different compared to when it is disabled. Hence, confirm the desired effects before using these functions.
- It may not be possible to acquire the effect of the MAPS function depending on the images to be printed. Hence, confirm the desired effects before using these functions.
- When printing with the 4 + 4SP ink set with the minimum number of passes, the MAPS function of special color is disabled.

Setting the MAPS2 function (4 color + special colored ink)

- 1 Press the [FUNCTION] key in LOCAL.

```
FUNCTION
SETUP          [ENT]
```

- 2 Press the [ENTER] key.

```
SETUP
DROP.POScorrect [ENT]
```

- 3 Press ▲ ▼ to select [MAPS].

```
SETUP
MAPS          [ENT]
```

- 4 Press the [ENTER] key.

```
MAPS
: OFF
```

- 5 Press ▲ ▼ to select [MAPS2], and press the [ENTER] key.

- Available settings: MAPS2, OFF
- If you have selected "OFF", then proceed to Step 11.

```
MAPS 2
: AUTO
```

6 Press ▲ ▼ to select "AUTO" or "MANUAL".

- AUTO:
Settings are performed automatically according to the printing conditions.
- MANUAL:
You can adjust the settings manually.

MAPS 2
: MANUAL

Important!

- If the feed stripes and uniformity of density are not improved by AUTO settings, adjust using MANUAL settings.

7 Press the [ENTER] key.

- If you have selected "AUTO" in Step 6, then proceed to Step 11.
- If you have selected "MANUAL" in Step 6, then proceed to Step 8.

COLOR >
PATTERN: 1

8 Press ▲ ▼ to set [COLOR].

- AUTO:
Patterns are set automatically depending on the printing conditions.
- PATTERN 1 to 5:
The pattern that you select is printed.

COLOR >
PATTERN: AUTO

9 Press the [ENTER] key.

- A screen for setting [SMOOTHING LV.] is displayed.

COLOR >
SMOOTHING LV.: AUTO

10 Press ▲ ▼ to set the [SMOOTHING LV.].

- AUTO:
Smoothing level is set automatically according to the printing conditions.
- 5 to 100%:
The effects of MAPS2 grow stronger when the value is increased and weaker when it is decreased.

COLOR >
SMOOTHING LV.: 50%

11 Press the [END] key, and then press ▶.

- A screen for setting [SPOT] is displayed.

< SPOT >
PATTERN: AUTO

12 Press ▲ ▼ to set the [SPOT].

- AUTO:
Patterns are set automatically depending on the printing conditions.
- PATTERN 1 to 5:
The pattern that you select is printed.

```
<      SPOT      >
PATTERN: 1
```

13 Press the [ENTER] key.

- A screen for setting [SMOOTHING LV.] is displayed.

```
<      SPOT      >
SMOOTHING LV.: AUTO
```

14 Press ▲ ▼ to set the [SMOOTHING LV.].

- AUTO:
Smoothing level is set automatically according to the printing conditions.
- 5 to 100%:
The effects of MAPS2 grow stronger when the value is increased and weaker when it is decreased.

```
<      SPOT      >
SMOOTHING LV.: 50%
```

15 Press the [END] key, and then press ▶.

- A screen for setting [CLEAR] is displayed.

```
<      CLEAR     >
PATTERN: AUTO
```

16 Press ▲ ▼ to set [CLEAR].

- AUTO:
Patterns are set automatically depending on the printing conditions.
- PATTERN 1 to 5:
The pattern that you select is printed.

```
<      CLEAR     >
PATTERN: 1
```

17 Press the [END] key, and then press ▼.

- A screen for setting [TYPE/LV.] is displayed.

```
<      CLEAR     >
TYPE/LV.: AUTO
```

18 Press ▲ ▼ to set the [TYPE/LV.].

- TYPE1 10 to 100%:
Set a value according to the printing conditions.
- TYPE2 10 to 100%:
Set a value according to the printing conditions.

< CLEAR
TYPE/LV.: AUTO

Important!

- The effects of MAPS2 differ depending on the images to be printed. Change print patterns, and check the effects in advance before using the MAPS2 function.

19 Press the [ENTER] key.

SETUP
MAPS [ENT]

20 Press the [END] key several times to end the operation.

3.9 WORK CHANGE Settings

Set whether to return to LOCAL mode or keep the REMOTE mode after online plotting is complete.

- 1** Press the [FUNCTION] key in LOCAL.

```
FUNCTION
VIEW [ENT]
```

- 2** Press ▲ ▼ to select [SETUP].

```
FUNCTION
SETUP [ENT]
```

- 3** Press the [ENTER] key.

```
SETUP
DROP.POScorrect [ENT]
```

- 4** Press ▲ ▼ to select [WORK CHANGE].

```
SETUP
WORK CHANGE [ENT]
```

- 5** Press the [ENTER] key.

```
WORK CHANGE
: OFF
```

- 6** Press ▲ ▼ to select the value to be set.

- OFF:
REMOTE mode is maintained after online plotting (When the next drawing data is received, it will be overwritten.)
- ON:
Y-bar is retracted after online plotting and the machine returns to LOCAL mode.
- HOST:
If you specify the "Print Count" to two or more on the RasterLink6 screen, the Y-bar is retracted after each print is completed and the machine returns to LOCAL mode.

```
WORK CHANGE
: ON
```



- The position where the Y-bar is retracted is the position set with  "Setting the VIEW Position"(P. 69).

- 7** Press the [ENTER] key.

```
SETUP
WORK CHANGE [ENT]
```

- 8** Press the [END] key several times to end the operation.

3.10 Ionizer Settings

Set the operations when the optional ionizer is installed.

Important!

- These settings are not displayed if the optional ionizer is not installed. If this setting is not displayed even though the ionizer is installed, contact your local distributor, or our sales office or call center.

1 Press the [FUNCTION] key in LOCAL.

FUNCTION
VIEW [ENT]

2 Press ▲ ▼ to select [SETUP].

FUNCTION
SETUP [ENT]

3 Press the [ENTER] key.

SETUP
DROP.POScorrect [ENT]

4 Press ▲ ▼ to select [IONIZER].

SETUP
IONIZER [ENT]

5 Press the [ENTER] key.

IONIZER
: ON

6 Press ▲ ▼ to select the value to be set.

- ON: For normal printing, the ionizer is turned on before printing starts and when printing is in process, and static electricity is removed. For reverse printing, static electricity is removed before printing. The ionizer power is turned on when shifting to [VIEW].
- OFF: Static electricity is not removed.

IONIZER
: OFF

7 Press the [ENTER] key.

SETUP
IONIZER [ENT]

8 Press the [END] key several times to end the operation.

3.11 AUTO CLEANING Settings

You can set this function so that it counts the number of printed files or printed length after printing is complete, performs cleaning automatically if required.

The machine can deliver stable output if its heads are always kept clean.

- 1** Press the [FUNCTION] key in LOCAL.

```
FUNCTION
VIEW [ENT]
```

- 2** Press ▲ ▼ to select [SETUP].

```
FUNCTION
SETUP [ENT]
```

- 3** Press the [ENTER] key.

```
SETUP
DROP.POScorrect [ENT]
```

- 4** Press ▲ ▼ to select [AUTO CLEANING].

```
SETUP
AUTO CLEANING [ENT]
```

- 5** Press the [ENTER] key.

```
AUTO CLEANING
: OFF
```

- 6** Press ▲ ▼ to select [AUTO CLEANING] type.

- Select "PAGE" in [AUTO CLEANING]. After printing the set number of times, head cleaning is automatically performed before the next printing starts.
- If you do not want to set [AUTO CLEANING], select "OFF" and proceed to Step 11.

```
AUTO CLEANING
: PAGE
```

- 7** Press the [ENTER] key.

- 8** Press ▲ ▼ to select cleaning interval.

- Available settings: 1 to 1000 pages

```
INTERVAL
= 1 page
```

- 9** Press the [ENTER] key.

```
TYPE
: SOFT
```

10 Press ▲ ▼ to set a cleaning type.

- Available settings: NORMAL/SOFT/HARD

TYPE
: NORMAL

11 Press the [ENTER] key.**12** Press the [END] key several times to end the operation.

Important!

- Depending on the state of the head, there are cases in which the print defects are not corrected even after running this function. In this case, contact your local distributor, or our sales office or call center.

3.12 Setting Nozzle Surface Cleaning Frequency

This function automatically cleans the nozzle face of the head and removes the ink droplets clinging to the nozzle face before or during printing.

- 1** Press the [FUNCTION] key in LOCAL.

```
FUNCTION
VIEW [ENT]
```

- 2** Press ▲ ▼ to select [SETUP].

```
FUNCTION
SETUP [ENT]
```

- 3** Press the [ENTER] key.

```
SETUP
DROP.POScorrect [ENT]
```

- 4** Press ▲ ▼ and select [INTERVAL WIPING].

```
SETUP
INTERVAL WIPING [ENT]
```

- 5** Press the [ENTER] key.

```
SETUP
INTERVAL WIPING [ENT]
```

- 6** Press ▲ ▼ to select the type of interval wiping.

- When you select "PAGE" in [INTERVAL WIPING], once the set number of prints is complete, the head nozzle is cleaned automatically before the next print starts.
- When you select "TIME" in [INTERVAL WIPING], the head nozzle is cleaned automatically once the print time exceeds the set time.
- If you do not want to set [INTERVAL WIPING], select "OFF" and proceed to Step 9.

```
INTERVAL WIPING
: PAGE
```

- 7** Press the [ENTER] key.

- 8** Press ▲ ▼ to set wiping interval.

- Available settings (PAGE): 1 to 100 pages
- Available settings (TIME): 3 to 50 min

```
INTERVAL
= 1 page
```

- 9** Press the [ENTER] key.

3.13 Other Settings

Change the settings according to the method of usage.

- 1 Press the [FUNCTION] key in LOCAL.

```
FUNCTION
VIEW [ENT]
```

- 2 Press ▲ ▼ to select [SETUP].

```
FUNCTION
SETUP [ENT]
```

- 3 Press the [ENTER] key.

```
SETUP
DROP.POScorrect [ENT]
```

- 4 Press ▲ ▼ to select the item you want to set.

- See  "List of Functions"(P. 79) when selecting.

- 5 Press the [ENTER] key.

- 6 Press ▲ ▼ to select the value to be set.

- See  "List of Functions"(P. 79) when selecting.

- 7 Press the [ENTER] key.

- 8 Press the [END] key several times to end the operation.









Important!

- The set value is retained even when the power is turned off.

3.14 Machine Settings

These are various settings to help you use this machine comfortably.

The following settings can be configured for the machine.

Item		Set value	Details
AUTO Power-off  "AUTO Power-off Settings"(P. 97)		NONE/10 to <u>30</u> to 600 min	If are no operations or a set time, the power turns off automatically.
TIME  "Time Settings"(P. 97)		+4 h to -20 h (Japan time)	Sets the current date and time.
UNIT  "Unit Settings"(P. 98)	TEMP.	°C (Celsius)/°F (Fahrenheit)	Sets the display unit for temperature.
	LENGTH	mm/inch	Sets the display units for length and area.
KEY BUZZER  "Key Buzzer Settings"(P. 99)		<u>ON</u> /OFF	Sets the buzzer sound for when a key is pressed.
LANGUAGE  "Language Settings"(P. 100)		<u>English</u> ニホンゴ Deutsch Français Español Italiano Português	Changes the display language.
NETWORK  "Network Settings"(P. 101)	Configures the network.		
	Check IP ADDRESS	Displays the IP address the machine is currently using.	
	Check MAC ADDRESS	Displays the MAC address the machine is currently using.	
	DHCP	<u>ON</u> /OFF	If set to "ON", an IP address received from the DHCP server is used.
	AutoIP	<u>ON</u> /OFF	If set to "ON", the IP address to be used is set according to the AutoIP protocol. However, if DHCP is ON, DHCP takes priority.
	IP ADDRESS ^{*1}	Set the IP address used by this machine.	
	DEFAULT GATEWAY ^{*1}	Sets the default gateway to be used.	
	DNS ADDRESS ^{*1}	Sets the DNS address used by this machine.	
SUB NET MASK ^{*1}	Sets the sub net mask to be used.		
External Stop I/F  "External Stop I/F"(P. 102)		<u>ON</u> /OFF	If you change the External Stop I/F in REMOTE mode, a warning is displayed, and the machine will switch to LOCAL mode.
RESET  "Resetting to Default Settings"(P. 109)		-	Returns all setting items to default values.

*1. Settable only when [DHCP] and [AutoIP] are both off

AUTO Power-off Settings

If are no operations or a set time, the power turns off automatically.

- 1 Press the [FUNCTION] key in LOCAL.

```
FUNCTION
VIEW [ENT]
```

- 2 Press ▲ ▼ to select [MACHINE SETUP].

```
FUNCTION
MACHINE SETUP [ENT]
```

- 3 Press the [ENTER] key twice.

```
AUTO Power-off
= 30min
```

- 4 Press ▲ ▼ to set the time when you want the power to turn off.

- Available settings: None, 10 to 600 min

```
AUTO Power-off
= 60min
```

- 5 Press the [ENTER] key.

```
MACHINE SETUP
AUTO Power-off [ENT]
```

- 6 Press the [END] key several times to end the operation.

-
- Important!** • In the AUTO Power-off state, the power turns on when data is received from the computer, but printing does not start automatically.
-

Time Settings

You can set the time (time difference) according to the country in which the machine is used.

- 1 Press the [FUNCTION] key in LOCAL.

```
FUNCTION
VIEW [ENT]
```

- 2 Press ▲ ▼ to select [MACHINE SETUP].

```
FUNCTION
MACHINE SETUP [ENT]
```

- 3 Press the [ENTER] key.

```
MACHINE SETUP
AUTO Power-off [ENT]
```





4 Press   to select [TIME].

MACHINE SETUP
TIME [ENT]

5 Press the [ENTER] key.

TIME
2018.10.05 21:30:00

6 Press     to enter time.

- Selecting Year/Month/Day/Time: Select using  .
- Inputting Year/Month/Day/Time: Input using  .

7 Press the [ENTER] key.

- The entered time is displayed.

TIME
2018.10.05 15:30:00

8 Press the [END] key several times to end the operation.



- Time can be set from -20 to +4 hours.

Unit Settings

You can set the units to be used for this machine.

1 Press the [FUNCTION] key in LOCAL.

FUNCTION
VIEW [ENT]

2 Press   to select [MACHINE SETUP].

FUNCTION
MACHINE SETUP [ENT]

3 Press the [ENTER] key.

MACHINE SETUP
AUTO Power-off [ENT]

4 Press   to select [UNIT].

MACHINE SETUP
UNIT [ENT]

5 Press the [ENTER] key.

TEMP.
: °C [ENT]

6 Press   to select a unit for temperature.

- Available settings: °C/°F

7 Press the [ENTER] key.

LENGTH
: mm

8 Press   to select a unit for length.

- Available settings: mm/inch

9 Press the [ENTER] key.

MACHINE SETUP
UNIT [ENT]

10 Press the [END] key several times to end the operation.

Key Buzzer Settings

You can turn off the buzzer that sounds when you press a key.

1 Press the [FUNCTION] key in LOCAL.

FUNCTION
VIEW [ENT]

2 Press   to select [MACHINE SETUP].

FUNCTION
MACHINE SETUP [ENT]

3 Press the [ENTER] key.



MACHINE SETUP
AUTO Power-off [ENT]

4 Press   to select [KEY BUZZER].

MACHINE SETUP
KEY BUZZER [ENT]

5 Press the [ENTER] key.

KEY BUZZER
: ON

- 6 Press   to select "ON" or "OFF".

KEY BUZZER
: OFF

- 7 Press the [ENTER] key.

MACHINE SETUP
KEY BUZZER [ENT]

- 8 Press the [END] key several times to end the operation.



- Even if the key buzzer is turned "OFF" the buzzer sounds for errors/warnings/completed operations cannot be turned off.

Language Settings

You can change the display language.

- 1 Press the [FUNCTION] key in LOCAL.

FUNCTION
VIEW [ENT]

- 2 Press   to select [MACHINE SETUP].

FUNCTION
MACHINE SETUP [ENT]

- 3 Press the [ENTER] key.

MACHINE SETUP
AUTO Power-off [ENT]

- 4 Press   to select [LANGUAGE].

MACHINE SETUP
LANGUAGE [ENT]

- 5 Press the [ENTER] key.

LANGUAGE
: English

- 6 Press   to select a language.

- Available settings:
ニホンゴ/English/Deutsch/Français/Español/Italiano/Português

LANGUAGE
: ニホンゴ

7 Press the [ENTER] key.

```
MACHINE SETUP
LANGUAGE [ENT]
```

8 Press the [END] key several times to end the operation.

Network Settings

1 Press the [FUNCTION] key in LOCAL.

```
FUNCTION
VIEW [ENT]
```

2 Press   to select [NETWORK] and press the [ENTER] key.

```
MACHINE SETUP
NETWORK [ENT]
```

3 Press the [ENTER] key.

- [Check IP ADDR.] is selected.
- This displays the IP address the machine is currently using.
- After checking, press the [ENTER] key.

```
NETWORK
Check IP ADDR.
```



- After connecting to the network, it takes time for the IP address to be confirmed. If the IP address is not set, [0.0.0.0] is displayed.

4 Press , and press the [ENTER] key.

- [Check MAC ADDR.] is selected.
- This displays the MAC address the machine is currently using.
- After checking, press the [ENTER] key.

```
NETWORK
Check MAC ADDR.
```

5 Press , and press the [ENTER] key.

- [DHCP] is selected.

```
NETWORK
DHCP
```

6 Press   to select "ON" or "OFF", and press the [ENTER] key.

```
DHCP
= ON
```

- Available settings: ON/OFF
- If set to "ON", an IP address received from the DHCP server is used.

7 Press \blacktriangledown , and press the [ENTER] key.

- [AutoIP] is selected.

NETWORK
AutoIP

8 Press \blacktriangle \blacktriangledown to select a setting, and press the [ENTER] key.

- Available settings: ON/OFF
- If set to "ON", the IP address to be used is set according to the AutoIP protocol. However, if DHCP is "ON", DHCP takes priority.

AutoIP
= ON

9 Press the [END] key several times to end the operation.

- To reflect the new network settings, turn the power off and back on.

External Stop I/F

In this machine, you can connect External Stop I/F to the I/F in the figure below (SMP-02V-BC).

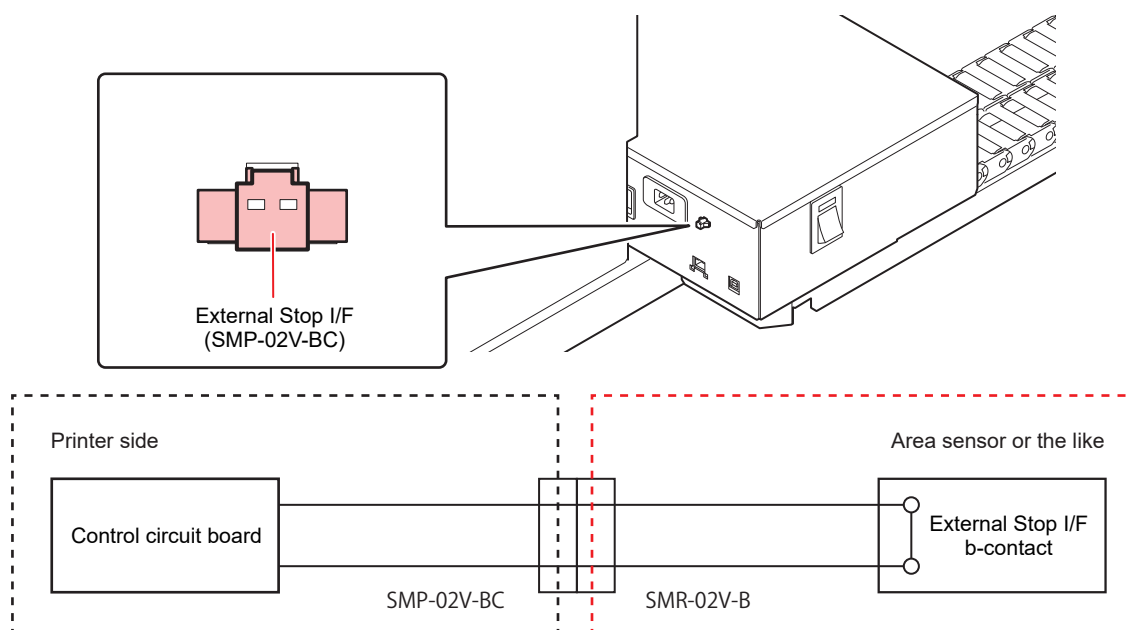

- Arrange for a connector (SMR-02V-B).
External Stop I/F specifications: b-contact (Normal Close)



- Never connect the power source of External Stop I/F anywhere except the sensor line.

External Stop I/F Settings

You can set the operation for when a stop sensor is connected to the External Stop I/F.

1 Press the [FUNCTION] key in LOCAL.

```
FUNCTION
VIEW [ENT]
```

2 Press ▲ ▼ to select [MACHINE SETUP].

```
FUNCTION
MACHINE SETUP [ENT]
```

3 Press the [ENTER] key.

```
MACHINE SETUP
AUTO Power-off [ENT]
```

4 Press ▲ ▼ to select [EXE I/F].

```
MACHINE SETUP
EXE I/F [ENT]
```

5 Press the [ENTER] key.

```
EXE I/F
: OFF
```

6 Press ▲ ▼ to select "ON" or "OFF".

- ON: Use External Stop I/F.
- OFF: Do not use External Stop I/F.

```
EXE I/F
: ON
```

7 Press the [ENTER] key.

```
MACHINE SETUP
EXE I/F [ENT]
```

8 Press the [END] key several times to end the operation.



- If you change the External Stop I/F in REMOTE mode, the following warning is displayed, and the machine will switch to LOCAL mode.

```
ERROR 513
SENSE OBSTRUCTION
```

- If an obstacle is detected, a warning is displayed, and the machine does not switch to REMOTE mode.
- The printing operation using the built-in pattern (Nozzle check, drop position correction) will continue regardless of the state of External Stop I/F.
- In LOCAL mode, External Stop I/F detection is always "OFF".
- If you do not know whether the sensor you are using is compatible with the I/F, consult our support team.

3.15 Nozzle Check Menu

This configures the operations related to Nozzle Missing check function.

Nozzle Check Menu List

Item		Set value	Details	
Printing Check ☞ "Printing Nozzle Check Settings"(P. 105)		ON/OFF	Set this to on if you want to perform nozzle check when starting online printing.	
(ON)	CHECK INTERVAL	FILE	1 to <u>30</u> to 100 files	
		LENGTH	0.1 to <u>30</u> to 50.0 m	
	CONTINUATION PRINT		ON/OFF	
	ACTION	CLEANING	NORMAL/HARD/ <u>SOFT</u>	Set the type of cleaning to perform during the recovery operation.
		RETRY COUNT	<u>0</u> to 3 times	Retries the operation a set number of times.
AUTO NOZZLE RECOVERY ☞ "Auto Nozzle Recovery Settings"(P. 107)		ON/OFF	Set this to automatically perform nozzle recovery.	
Judgment Condition ☞ "Judgment Condition Settings"(P. 107)	C, M, Y, K, Lc, Lm, W, Cl, Pr	<u>1</u> to 64	Sets how many nozzles for each color must be detected as missing to judge "Nozzle Missing". (16 nozzles in each nozzle line)* ²	

*1. If in the middle of the printing process, the machine reaches the set length, the nozzle is checked at the beginning of the next print.

*2. Nozzle recovery may not be applicable depending on the print conditions.

Printing Nozzle Check Flow

Nozzle check is performed at the start of the printing process according to the following flow.



- This is enabled when "Printing Nozzle Check" is set to "ON".
- RETRY and AUTO NOZZLE RECOVERY are set only when this setting is enabled.

1. Nozzle check → judgment

Detects missing nozzles.

2. Action → nozzle check → judgment

If more missing nozzles than the "Judgment Condition" are detected after the nozzle check, perform cleaning and run the nozzle check again.

3. Retry → judgment

If more missing nozzles than the "Judgment Condition" are detected after the recovery operation, the recovery operation is re-run.

- This applies if the "RETRY COUNT" is set to 1 or more.

4. Auto nozzle recovery → judgment

If more missing nozzles than the "Judgment Condition" are still detected in the last judgment, it is judged that printing cannot continue, and printing stops.

- This applies when "AUTO NOZZLE RECOVERY" is set to "ON".

5. Nozzle missing judgment

Finally, if more missing nozzles than the "Judgment Condition" are still detected, it is judged that printing cannot continue, and printing stops.

Print Operations During "Nozzle Missing" Judgment and Error Occurrence

- Printing stops if "Nozzle Missing" is judged.
 - Printing stops.
- When an error occurs during nozzle check
 - Printing stops and [Printing Nozzle Check] is automatically set to "OFF". After recovering from the error, re-configure "Printing Nozzle Check".

Printing Nozzle Check Settings

Set this to "on if you want to perform nozzle check when starting online printing.

- 1 Press the [FUNCTION] key in LOCAL.

FUNCTION
VIEW [ENT]

- 2 Press   to select [NOZZLE CHECK].

FUNCTION
NOZZLE CHECK [ENT]

- 3 Press the [ENTER] key.

NOZZLE CHECK
: Printing Check

4 Press   to select "ON" and press the [ENTER] key.

- Available settings: ON/OFF
- Select "OFF" to disable Printing Nozzle Check.

Printing Check
= ON

5 Press the [ENTER] key, and select [Check Interval].

Printing Check
: Check Interval

6 Press   to select the setting item and press the [ENTER] key.

- Available settings: LENGTH/FILE
- LENGTH:
The nozzle is checked once a certain set length has been printed.
- FILE:
The nozzle is checked once a certain number of files have been printed.

SETUP
= FILE

7 Press   to select the setting value and press the [ENTER] key.



- LENGTH: 0.1 to 50.0
- FILE: 1 to 100

INTERVAL
= 30

8 Press   to select [CONTINUATION PRINT], and press the [ENTER] key.

- The [CONTINUATION PRINT] setting screen is displayed.

Printing Check
: CONTINUATION PRINT

9 Press   to select "ON" or "OFF", and press the [ENTER] key.

- Available settings: ON/OFF

CONTINUATION PRINT
= ON

10 Press   to select "ACTION" and press the [ENTER] key.

Printing Check
: ACTION

11 Press   to select the setting value and press the [ENTER] key.

- Available settings: NORMAL/HARD/SOFT

CLEANING
= SOFT

12 Press   to select the setting value and press the [ENTER] key.

- Available settings: 0 to 3

RETRY COUNT	
=	1

13 Press the [END] key to end the operation.

Auto Nozzle Recovery Settings

1 Press the [FUNCTION] key in LOCAL.

FUNCTION	
VIEW	[ENT]

2 Press   to select [NOZZLE CHECK].

FUNCTION	
NOZZLE CHECK	[ENT]

3 Press   to select [AUTO NOZZLE RECOVERY].

NOZZLE CHECK	
: AUTO NOZZLE RECOVERY	

4 Press   to select "ON" and press the [ENTER] key.

- Available settings: ON/OFF
- Select "OFF" to disable AUTO NOZZLE RECOVERY.

AUTO NOZZLE RECOVERY	
=	ON

5 Press the [END] key to end the operation.

Judgment Condition Settings

1 Press the [FUNCTION] key in LOCAL.

FUNCTION	
VIEW	[ENT]

2 Press   to select [NOZZLE CHECK].

FUNCTION	
NOZZLE CHECK	[ENT]

3 Press ▲ ▼ to select [Judgment Condition].

NOZZLE CHECK
: Judgment Condition

4 Press ▲ ▼ to select the setting value and press the [ENTER] key.

- Available settings: 1 to 64
- Each time you press the [ENTER] key, the target color changes.

C
= 1



- The displayed color differs according to the ink set.
-



5 Press the [END] key to end the operation.

3.16 Resetting to Default Settings

The details set in [SETUP] [MAINTENANCE] and [MACHINE SETUP] are returned to factory default settings.

- 1 Press the [FUNCTION] key in LOCAL.

```
FUNCTION
VIEW [ENT]
```

- 2 Press   to select [MACHINE SETUP].

```
FUNCTION
MACHINE SETUP [ENT]
```

- 3 Press the [ENTER] key.

```
MACHINE SETUP
AUTO Power-off [ENT]
```

- 4 Press   to select [RESET].

```
MACHINE SETUP
RESET [ENT]
```

- 5 Press the [ENTER] key.

```
RESET ALL SETTING
ARE YOU SURE? [ENT]
```

- 6 Press the [ENTER] key.

- Initializes settings.



```
RESET
EXECUTE [ENT]
```

- 7 Press the [END] key several times to end the operation.

3.17 Confirming Machine Information

You can check the information of this machine.

The following items can be checked as the machine information.

Item		Details
USAGE  "Checking Machine Usage Status"(P. 110)	WIPING	This displays the usage status of the machine.
	PRINT LENGTH	
	PRINT AREA	
	USE TIME	
	WASTE INK TANK	
	UV LAMP	
VERSION  "Checking Version Information"(P. 111)		This displays the firmware version of the machine.

Checking Machine Usage Status

You can check the machine information such as wiping information and the length printed with this machine.

- 1 Press the [FUNCTION] key in LOCAL.

FUNCTION
VIEW [ENT]

- 2 Press   to select [INFORMATION].

FUNCTION
INFORMATION [ENT]

- 3 Press the [ENTER] key.

INFORMATION
USAGE [ENT]

- 4 Press the [ENTER] key.

- Wiping information is displayed.
- Each time you press the [ENTER] key, subsequent information is displayed in order.

WIPING
= 0

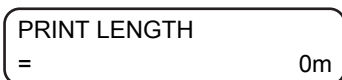
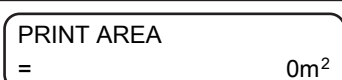
WIPING	Displays wiping information	
PRINT LENGTH	Displays the printed length up to this point	
PRINT AREA	Displays the printed area up to this point	

WASTE INK TANK	Displays how full the waste ink tank is	WASTE INK TANK = 0%
UV LAMP	Displays the usage time of UV lamps 1 and 2	UV LAMP 1: LED A = 0h

Checking Version Information

1 Press the [FUNCTION] key in LOCAL.

FUNCTION
VIEW [ENT]

2 Press   to select [INFORMATION].

FUNCTION
INFORMATION [ENT]

3 Press the [ENTER] key.

INFORMATION
USAGE [ENT]

4 Press   to select [VERSION].



INFORMATION
VERSION [ENT]

5 Press the [ENTER] key.

- When you select [ERROR HISTORY], the error history of the machine is displayed.
- When you select [VERSION], the version information of the machine is displayed.
- When you select [LIST], the setting details of the machine are printed.
- When you select [Ink REPL.Report], the history of the ink used is printed.

About Displayed Information

This section explains how to read the displayed information.

ERROR HISTORY	Displays the date of occurrence	[00000] 2018/07/19 22:13:00
	Error details are displayed in  	ERROR 12a ***** HDC SPEED
Version	Displays the version information such as F/W	JFX200-2513EX V1.00 MRL-III V2.20

Displaying other information

1 Press the [ENTER] key in LOCAL.

```
***INK      MMCCYYKK
REMAIN     99999999
```

2 Each time you press the [ENTER] key, subsequent details are displayed in order.

- The following information is displayed.
- Remaining amount of ink

```
***INK      MMCCYYKK
REMAIN     99999999
```

- Error display (for ink error)

```
NON-ORIGINAL INK
MMCCYYKK
```

- Warning display (for warning)

```
WARNING
REPLACE WIPER [MNT]
```

- Serial No.

```
SERIAL NO.
: *****
```

- Version

```
JFX200-2513EX  V1.00
MRL-III       V2.20
```

- Main PCB Information

```
MAIN PCB      EPL3B
```

- Nozzle recovery
Press the [MAINT.] key to check the details

```
NOZZLE RECOVERY : 1
CONFIRM         [MNT]
```

3 Press the [ENTER] key to return to LOCAL.

Stopping the circulation/agitation operation while power is off

When white ink is used in the machine, start up the machine periodically to perform the circulation/agitation operation to prevent the ink from settling. (during operation, the remaining time is indicated at the bottom of the display)

Circulating

```
CIRCULATION
0 : 09 : 40
```



Agitating

```
AGITATION
0 : 12 : 35
```

If you want to cancel the circulation or agitation operation so as to use the machine, press the [END] key.

When you press the [END] key, a selection screen to continue/cancel the operations is displayed.



- To continue the circulation/agitation operation: Press  (returns to the display during operations)
- To cancel the circulation/mixing operation: Press  (returns to the local screen after initializing operation)

Chapter 4 Maintenance



This chapter

This chapter explains the necessary items for comfortable use of this machine, such as methods of daily maintenance and ink cartridge maintenance.

Daily maintenance	116	Automatic Maintenance Function	149
Precautions for maintenance	116	Setting the refresh intervals	149
About Washing Liquid	116	Setting the Cleaning Interval.....	150
Maintenance timing	116	Replacement of Consumables	152
Maintenance of Machine Exterior.....	117	Replacing the wiper	152
Table Maintenance.....	118	Replacing Carriage Filters	153
MBIS maintenance.....	118	Disposing the Waste Ink	154
LM guide cleaning	119	Replacing the waste ink tank before the waste ink tank confirmation message is displayed (1)	157
Ionizer Maintenance.....	119	Replacing the waste ink tank before the waste ink tank confirmation message is displayed (2)	157
Maintaining the Capping Station	120	About Refilling the Cooling Water	159
Cleaning wiper and cap.....	120	Refilling the Coolant.....	160
Cleaning the NCU	126	Flushing Filter.....	162
Cleaning around the station	127	Replacing the Flushing Filter	162
Washing the Ink Discharge Passage	128	Replacing the flushing filter before the replacement message is displayed	163
When the Machine Is Not Used For a Long Time	129		
Maintenance of Head Surroundings	132		
Cleaning LED UV Unit.....	133		
When Nozzle Clogging Cannot Be Solved	134		
Filling with ink from the sub tank to the head	134		
Washing of head nozzle.....	135		
Washing the Head Nozzle (When Using the PR-200 INK).....	137		
Performing Air Purge.....	140		
NOZZLE RECOVERY Function	144		

4.1 Daily maintenance

Conduct the machine maintenance periodically or depending on the operation frequency of the machine, in order to use it for a long time while maintaining its accuracy.

Precautions for maintenance

Pay attention to the following items when maintaining this machine.



- LED UV unit becomes very hot. Turn off the LED UV unit and perform maintenance once the device cools down sufficiently. There is a risk of burns.



- Switch off the power button and unplug the power cable before cleaning. It may cause unexpected accidents.
- If you will not be using the machine for a long time, make sure you remove the power cable from the outlet and remove the media that is set in the machine.



- When handling ink and washing liquid, pay close attention to ventilation and be sure to wear the included safety glasses and gloves. The ink or washing liquid may get in your eyes.



- Do not use chemicals containing benzene, thinner or abrasives. It may cause degeneration/ deformation of cover surface.
- Do not lubricate the inside of device with lubricating oil or other agents. Doing so may cause malfunction.
- Make sure the washing liquid and ink do not get on the cover. This may cause degeneration/ deformation of the cover surface.
- Aggregates are generated in the UV ink (ultraviolet curable ink) if it is mixed with water and alcohol. Do not let water or alcohol stick on the nozzle surface, cap, wiper, or anywhere near the head.



- Never disassemble or modify this machine or ink bottle. Disassembling or modifying will result either in electric shock or malfunction of this machine.



- Do not let moisture enter this machine. If the inside of the machine gets wet, it may cause electric shock and damage.

About Washing Liquid

Use a washing liquid that is compatible with the ink being used.

Type of ink	Compatible washing liquid
UV ink	<ul style="list-style-type: none"> • F-200/LF-200 Washing Liquid (PN : SPC-0568) • F-200/LF-200 CLEANING KIT (PN : SPC-0569)

Maintenance timing

Maintenance timing	Maintenance items (reference page)
Daily (after one day of work)	"Maintenance of Head Surroundings"(P. 132)
	"Cleaning wiper and cap"(P. 120)
	"Cleaning the NCU"(P. 126)

Maintenance timing	Maintenance items (reference page)
Twice a week	☞ "Washing the Head Nozzle (When Using the PR-200 INK)"(P. 137)
Weekly (after a week of work)	☞ "Maintenance of Machine Exterior"(P. 117)
	☞ "Table Maintenance"(P. 118)
	☞ "Washing the Ink Discharge Passage"(P. 128)
	☞ "Disposing of Waste Ink"(P. 155)
	☞ "Cleaning around the station"(P. 127)
About once every one or two weeks	☞ "Replacing Carriage Filters"(P. 153)
	☞ "MBIS maintenance"(P. 118)
Once a month	☞ "Washing the Head Nozzle (When Using the PR-200 INK)"(P. 137)
When an error occurs	☞ "Refilling the Coolant"(P. 160)
	☞ "Replacing the wiper"(P. 152)
Maintenance as necessary	☞ "Cleaning LED UV Unit"(P. 133)
	☞ "Ionizer Maintenance"(P. 119)

Tools necessary for maintenance	
F-200/LF-200 Washing Liquid (PN : SPC-0568)	PR-200 Washing Liquid (PN : C-ML013-Z-B2-1-KW) *When using the PR-200 ink
Cotton swab	Cleaning Stick for Head Surrounding (PN : SPC-0527)
Soft cloth	Gloves

Maintenance of Machine Exterior

Depending on the usage environment, trash and dust may stick to the exterior of the main unit. To prevent dust from entering the head moving part, soak a soft piece of cloth in water, wring it tightly and then wipe off the dust.

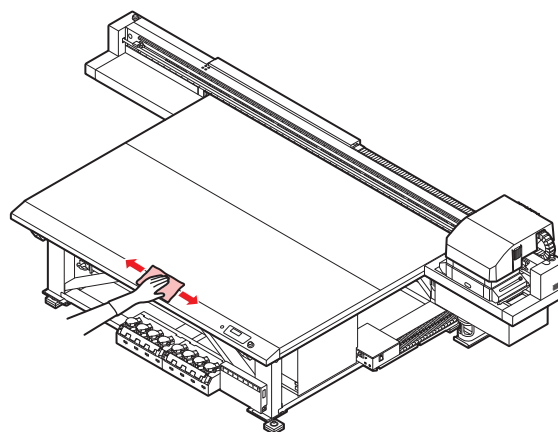
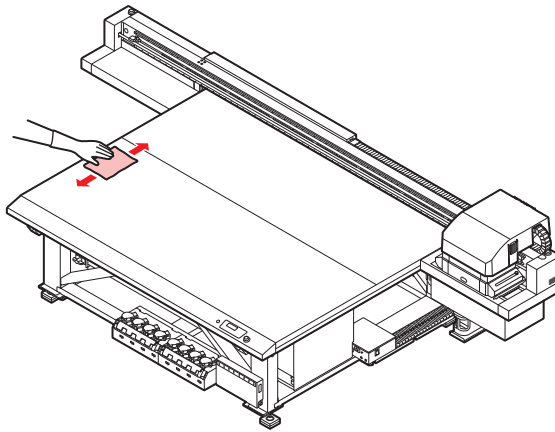

Table Maintenance

If there is dirt or ink adhering to the table, wipe it off with a cloth soaked in ethanol.



Important!

- If the ink is left stuck to the table for a long time, it becomes difficult to remove it using ethanol.
- The ink may stick to the vacuum hole of the table surface and clog it. Remove the ink from the vacuum hole as and when necessary. When removing the ink, do not leave fragments of hardened ink on the table surface.

MBIS maintenance

Please replace the Bottle Wiping Filter (PN: SPC-0820) if it gets dirty.

1 Remove the bottle wiping filter.

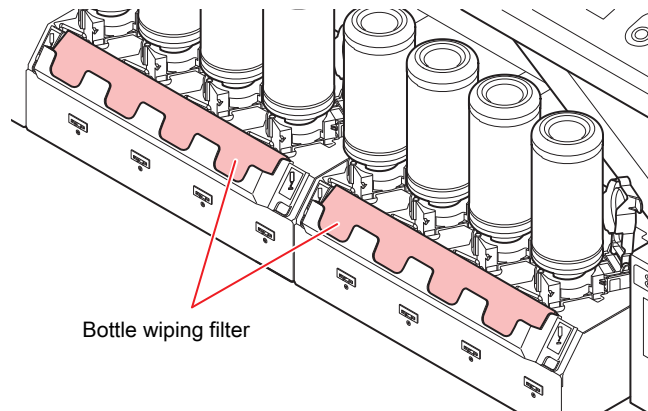

2 Attach a new Bottle Wiping Filter (PN: SPC-0820).

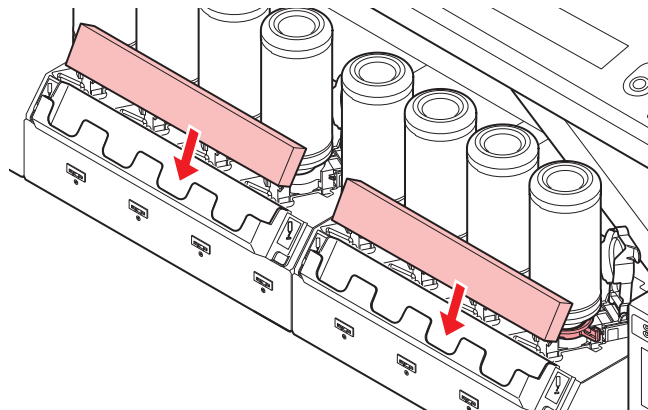

LM guide cleaning

When the LM guide gets dirty, wipe it off with a soft, dry cloth.

- Important!** • Do not wipe with ethanol.

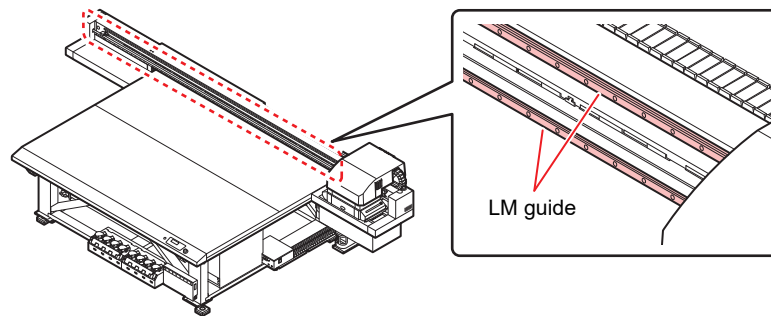

Ionizer Maintenance

Follow the instruction manual when performing ionizer (option) maintenance.

4.2 Maintaining the Capping Station

Maintain the ink cap and wiper in the capping station. (STATION MAINT.)

The ink cap and wiper function as described below.

- Wiper:
Wipes off any ink on the head nozzle
- Ink cap:
Prevents the clogging of head nozzles due to dryness

As you use this machine, the wiper and ink cap start getting dirty from ink and dust.

If nozzle clogging is not resolved even after head cleaning is implemented  "Head Cleaning"(P. 66), use the washing liquid and a clean stick for cleaning.

Tools required for maintenance	• F-200/LF-200 Washing Liquid (PN : SPC-0568)	• Safety glasses
	• Cleaning Stick for Head Surrounding (PN : SPC-0527)	• Gloves



- When performing maintenance for the capping station, be sure to wear the included safety glasses and gloves. Otherwise you may get ink in your eyes.



- Do not remove the capping station from the carriage with your hands. If you want to move the carriage, press the [MAINT.] key and execute carriage out.
 "Cleaning wiper and cap"(P. 120)(Steps 1 to 2)
- Make sure you perform maintenance for the ink cap and wiper in the capping station everyday. If they are left dirty, the nozzle surface may get dirty, dust or hardened ink may get stuck to the nozzle, resulting in poor discharge.

Cleaning wiper and cap



- Clean the wiper and the surrounding area twice a week (frequency of cleaning differs depending on the usage frequency of the printer).
- If there are severe bends or dirt on the wiper, replace it with a new wiper.
 "Replacing the wiper"(P. 152)
- When cleaning, make sure no fibers from the clean stick are left behind. Residual fibers may cause the printing quality to deteriorate.

1 Press the [MAINT.] key in LOCAL.

CARRIAGE OUT

[ENT]

2 Press the [ENTER] key.

MOVE POSITION
: STATION MAINT.

3 Press to select [STATION MAINT.].

MOVE POSITION
: STATION MAINT.

4 Press the [ENTER] key.

- Carriage moves onto the table.

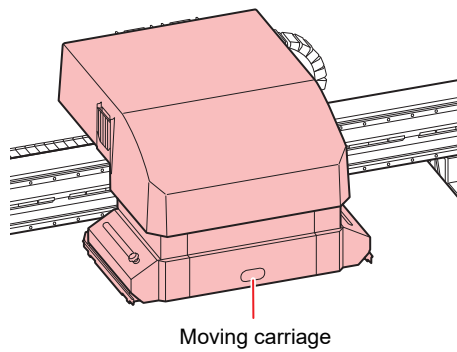

5 Remove the wiper.

- Pull out the wiper by holding the protrusions at both the ends.

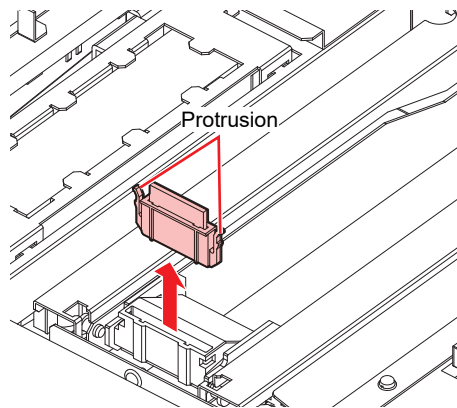

6 Clean the wiper and the bracket.

- Wipe off any ink on the wiper and the bracket using a clean stick soaked in washing liquid. Wipe it off properly so that there is no residual washing liquid.

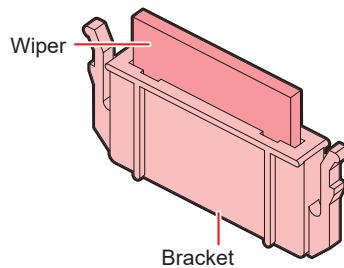



- Clean the wiper and the bracket until they look like the picture.

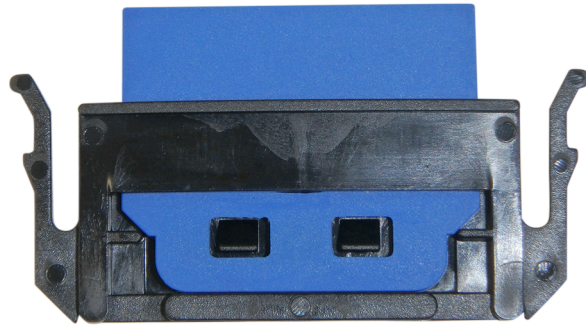

- After cleaning, make sure the wiper and bracket are aligned horizontally.
-

7 Clean the wiper cleaner.

- Clean the tip of the wiper cleaner with a clean stick.

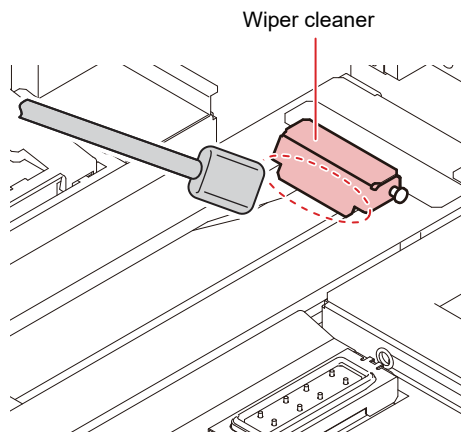

- Lift the wiper cleaner up and clean the ink adhering to the inside with a clean stick.

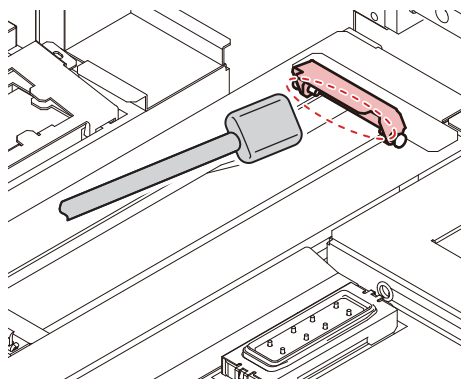

- Clean around the wiper cleaner.

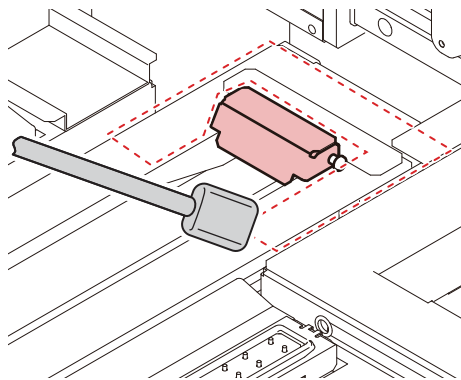

- Do not remove the wiper cleaner from the bracket.
- Only clean the front side of the wiper cleaner. (There is no need to clean the backside)
- After cleaning the wiper cleaner, check that the cleaner is not facing up.

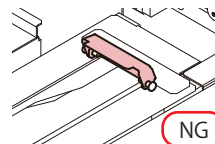
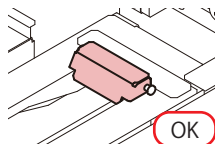

8 Return the wiper to its original position.

- Insert the wiper by holding both the ends.

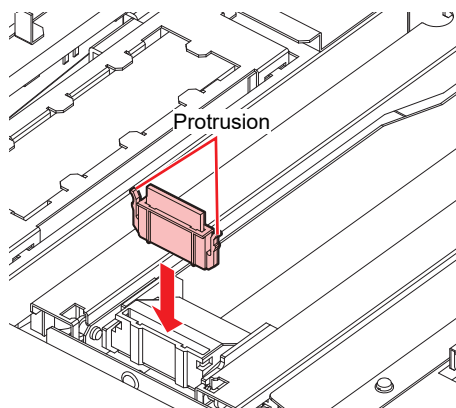

9 Clean the cap rubber and cap rubber cover.

- Wipe off any ink on the cap rubber and the cap rubber cover using a clean stick soaked in washing liquid. Wipe it off properly so that there is no residual washing liquid.

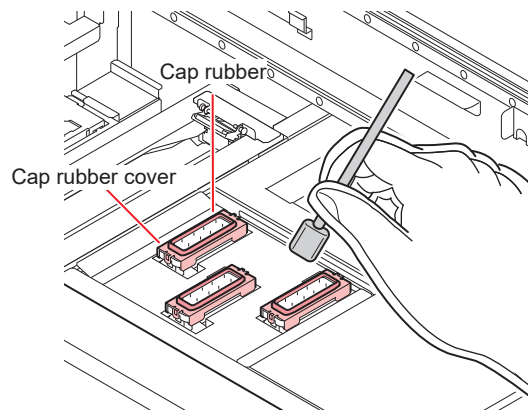

- Clean the cap rubber and cap rubber cover until they look like the picture.



- After cleaning, make sure the cap rubber and the mesh inside the cap have not come off.

10 Once the cleaning is complete, press the [ENTER] key.

- After the initial operation, the display returns to Step 1.

Performing station maintenance without [MAINT.] key

You can select [STATION MAINT.] using the [FUNCTION] key under LOCAL, without pressing the [MAINT.] key.

- 1** Press the [FUNCTION] key in LOCAL.
- 2** Press ▲ ▼ to select [MAINTENANCE].
- 3** Press the [ENTER] key twice.
 - This will put the machine in the same state as when you press the [MAINT.] key in LOCAL.

Cleaning the NCU

Ink and dust adhere to the NCU.

The NCU cannot operate normally if there is ink or dust adhering to it.

- 1 Press the [MAINT.] key in LOCAL.

CARRIAGE OUT
[ENT]

- 2 Press the [ENTER] key.

MOVE POSITION
: STATION MAINT.

- 3 Press ▲ ▼ to select [STATION MAINT.].

MOVE POSITION
: STATION MAINT.

- 4 Press the [ENTER] key.

- Carriage moves onto the table.

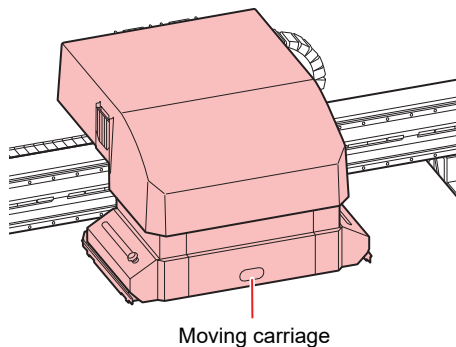

- 5 Wipe off any ink or dust adhering to the NCU.

- Wipe the inside and the outside with a clean stick (SPC-0421) soaked in washing liquid.
- Wipe it off properly so that there is no residual washing liquid.

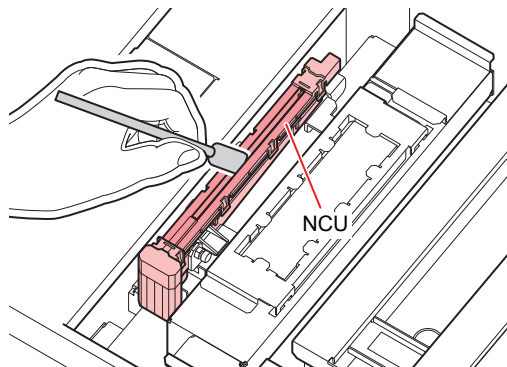

- 6 Once the cleaning is complete, press the [ENTER] key.

- After the initial operation, the display returns to Step 1.

Cleaning around the station

We recommend that you clean the machine often to maintain the quality of the machine and the images.

(Important!)

- Clean the area around the station twice a week (frequency of cleaning differs depending on the usage frequency of the printer).
- If the ink left in the waste ink tray hardens due to UV light, the ink discharged during flushing cannot move to the waste ink bottle. We recommend that you clean the waste ink tray often.

1 Press the [MAINT.] key in LOCAL.

CARRIAGE OUT
[ENT]

2 Press the [ENTER] key.

MOVE POSITION
: STATION MAINT.

3 Press ▲ ▼ to select [STATION MAINT.] and then press the [ENTER] key.

- Carriage moves onto the table.
- Clean the waste ink tray.

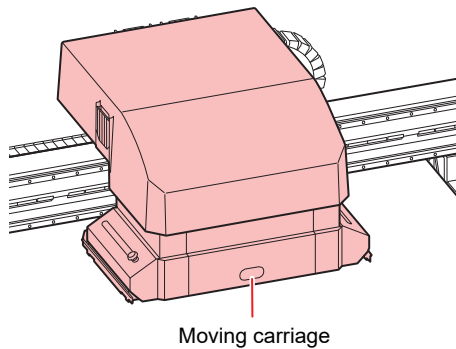

4 Use a cloth to wipe off the ink around the waste ink tray.

- Clean the gray area shown in the figure below.
- If the ink is stuck to the surface and cannot be wiped, use a spatula or another similar tool to scrape it off.

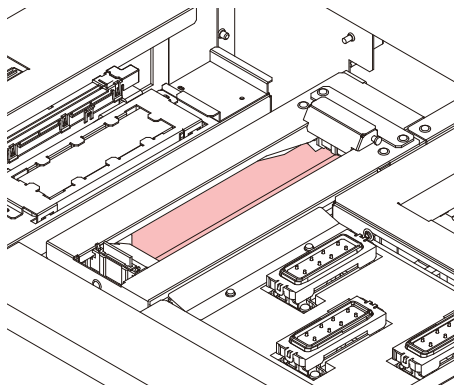

5 Wipe off any ink on the flushing unit or the shutter.

- Wipe off the ink using a clean stick soaked in washing liquid. Wipe it off properly so that there is no residual washing liquid.

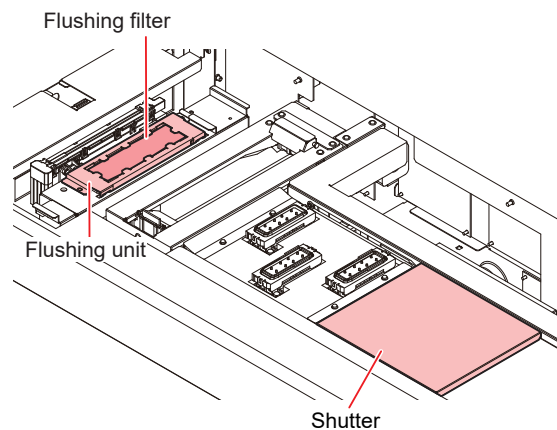

-
- Important!**
- If the surface of the flushing filter has become fluff, wipe it using a clean stick soaked in washing liquid.
 - If the dirt is severe or hardened, replace the flushing filter. 🗑️ ["Flushing Filter"\(P. 162\)](#)
-

6 Once the cleaning is complete, press the [ENTER] key.

- After the initial operation, the display returns to Step 1.

Washing the Ink Discharge Passage

Wash the ink discharge passage periodically to prevent ink from hardening and clogging inside it.

1 Press the [MAINT.] key in LOCAL.

CARRIAGE OUT [ENT]

2 Press ▲ ▼ to select [DISWAY WASH].

DISWAY WASH [ENT]

3 Press the [ENTER] key.

- Carriage moves onto the table.
- Repeat the dry suction operation until the washing is complete.

DISWAY WASH
COMPLETED (NEXT) [ENT]

4 Take washing liquid in a dropper and fill the cap with it until it is full.

- Fill the cap with washing liquid until it is about to overflow.

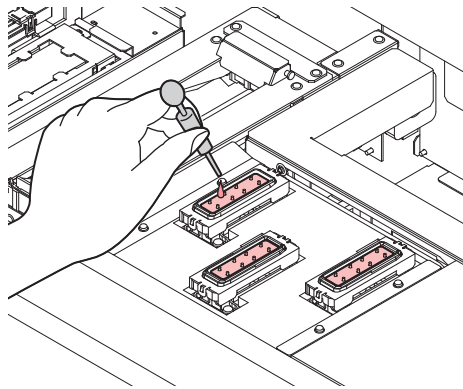

5 Press the [ENTER] key.

- After the dry suction operation is performed for 30 seconds, the display returns to Step 2.

DISWAY WASH
PLEASE WAIT

When the Machine Is Not Used For a Long Time

When the machine is not going to be used for a week or more, use the cleaning function for storage to clean the head nozzles and ink discharge passage. After this, keep the machine in custody.

Check these items in advance	<p>Is [INK END] displayed?</p> <ul style="list-style-type: none"> • The ink is absorbed during washing. If the ink end is detected at this time, washing cannot be performed. • Replace the ink bottle with another one for which the ink end has not been detected.
------------------------------	--

1 Press the [MAINT.] key in LOCAL.

CARRIAGE OUT [ENT]

2 Press ▲ ▼ to select [CUSTODY WASH].

CUSTODY WASH [ENT]

3 Press the [ENTER] key.

- Carriage moves onto the table.

WIPER CLEANING
COMPLETED [ENT]

- Important!**
- [COMPLETED (NEXT): ENT] is displayed on the screen until the cleaning work of wiper and bracket is complete. Press the [ENTER] key after Step 4 is complete. If you press the [ENTER] key before the cleaning is complete, the machine moves to the next washing step.

4 Clean the wiper and the bracket.

- (1) Pull out the wiper by holding the protrusions at both the ends.
- (2) Use a clean stick soaked in washing liquid.
 - Wipe it off properly so that there is no residual washing liquid.
- (3) Hold the wiper by the protrusions at both the ends and push it back to the original position.

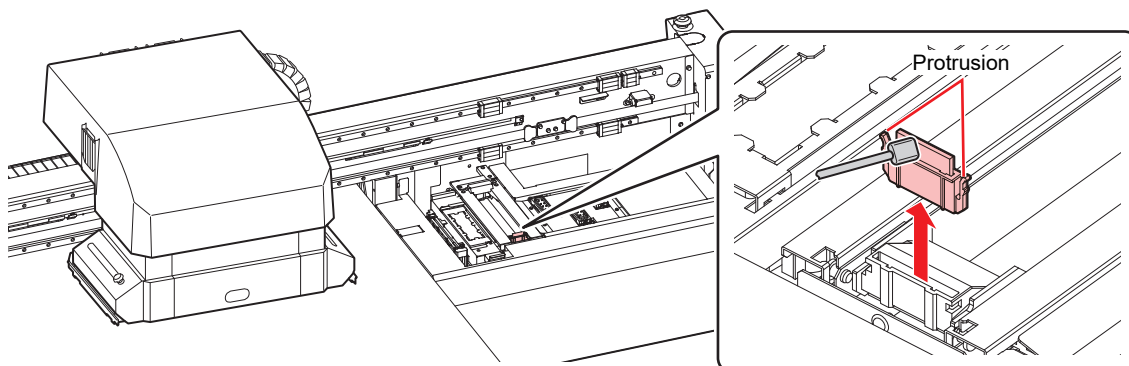

5 Press the [ENTER] key.

CAP CLEANING
COMPLETED (NEXT) [ENT]

Important!

- [COMPLETED (NEXT):: ENT] is displayed on the screen until the cleaning of the cap is complete. Press the [ENTER] key after Step 6 is complete. If you press the [ENTER] key before the cleaning is complete, the machine moves to the next washing step.

6 Clean the cap rubber and cap rubber cover.

- Wipe off any ink on the cap rubber and the cap rubber cover using a clean stick soaked in washing liquid. Wipe it off properly so that there is no residual washing liquid.
- At this time, the discharge passage is cleaned automatically.

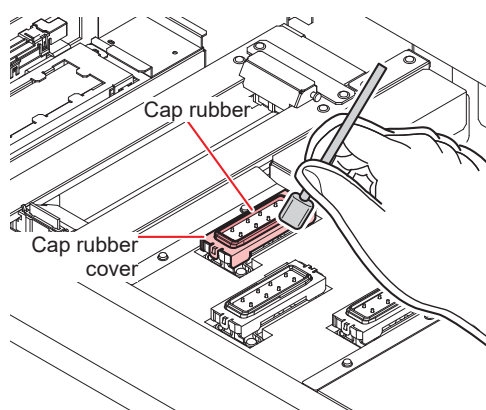

7 Press the [ENTER] key.

FILL THE LIQUID.
COMPLETED (NEXT) [ENT]

Important!

- [COMPLETED (NEXT): ENT] is displayed on the screen until the washing liquid is filled. Press the [ENTER] key after Step 8 is complete. If you press the [ENTER] key before the maintenance liquid is filled, the carriage returns to its original position.

8 Take washing liquid in a dropper and fill the cap with it until it is full.

- Fill the cap with washing liquid until it is about to overflow.

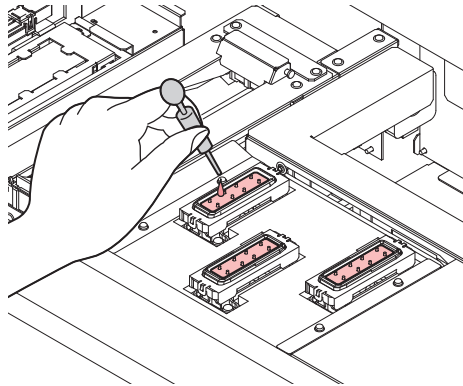

9 Press ▲ ▼ to enter the leaving time. (Supported from firmware version 2.6 onward)

10 Press the [ENTER] key.

- This will clean the nozzles.
- The head moves when nozzle cleaning is complete.

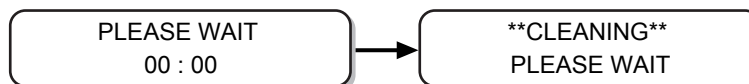

11 Take washing liquid in a dropper and fill the cap with it until it is full.

- Fill the cap with washing liquid until it is about to overflow.

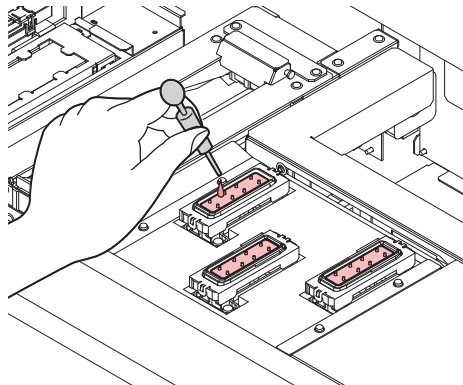

12 Press the [ENTER] key.

- After the initial operation, the display returns to Step 2.

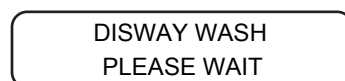
**Important!**

- If the device is not going to be used (output) for a long period of time, a small amount of ink must be discharged periodically (flushing) to ensure stability in discharge of ink.
- Turn off only the front power button after executing the cleaning function for storage. Keep the main switch on the right side turned on (|) and keep the socket plugged in.

4.3 Maintenance of Head Surroundings

Extremely minute mechanisms are used for the head, and therefore proper care must be taken when performing maintenance.

Some gel-like ink or dust may be stuck in the bottom part of the slider and around the head. Rub it off using a clean stick or another similar tool. When rubbing, make sure you never rub the nozzle part of the head.

Tools required for cleaning	• Cleaning Stick for Head Surrounding (PN : SPC-0527)	• Safety glasses	• Gloves
------------------------------------	---	------------------	----------



- If the ink gets on your skin or your clothes, rinse it out immediately with soap or water. If you get the ink in your eyes, wash them immediately with water and consult a doctor.



- When handling ink and washing liquid, pay close attention to ventilation and be sure to wear the included safety glasses and gloves. The ink or washing liquid may get in your eyes.



- Make sure you clean the bottom surface of the carriage everyday so that it does not get dirty from ink or dust. If it is left dirty, dirt or hardened ink may smear onto the nozzle due to wiper operation during head cleaning.
- When you clean the bottom surface of the carriage, be careful so as not to rub the nozzle.

1 Remove the cover on the right side of the Y-bar.

- Remove the screws (2 places) and remove the cover.

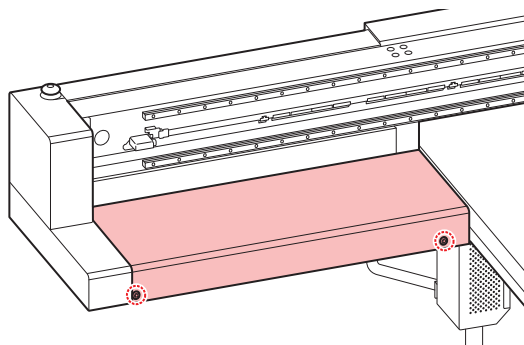

2 Press the [MAINT.] key in LOCAL.

CARRIAGE OUT
[ENT]

3 Press the [ENTER] key.

MOVE POSITION
: STATION MAINT.

4 Press ▲ ▼ to select [HEAD MAINT.].

MOVE POSITION
: HEAD MAINT.

5 Press the [ENTER] key.

- Carriage moves to the left edge of the machine.

6 Wipe any ink on the sides of the head and carriage using a clean stick.

- Never rub the nozzle part.

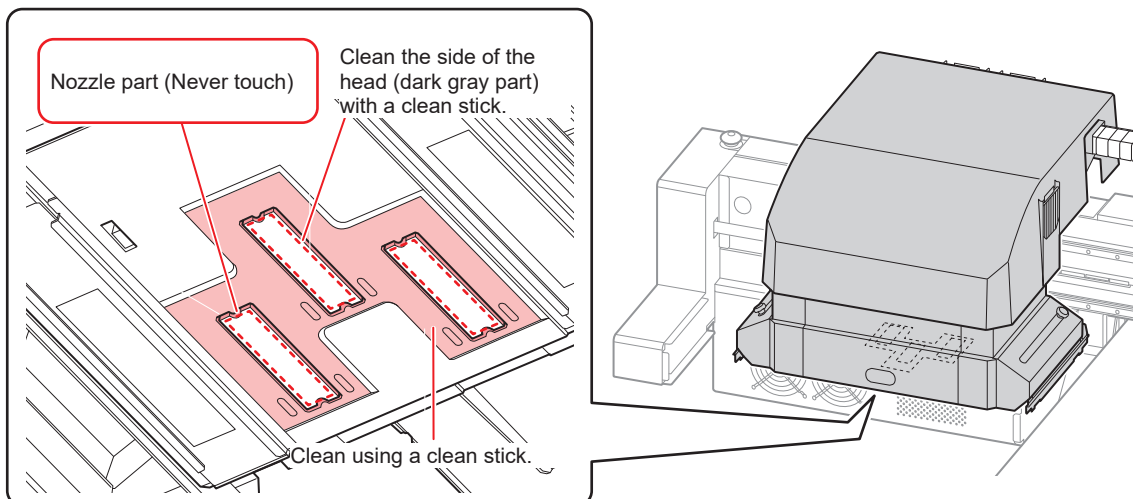

Important!

- Clean the side of the head and the carriage bottom until they look like the picture.
- Clean the nozzle surface if the shape of the cap rubber is visible on it.
- If you need to leave your seat during maintenance, press the [ENTER] key to end the cleaning process. If left as-is, the ink will harden due to the effects of external light, resulting in nozzle clogging or other harmful effects.



7 Once the cleaning is complete, press the [ENTER] key.

HEAD MAINT.
COMPLETED [ENT]

Cleaning LED UV Unit



Periodically clean the ink and dust stuck on the LED UV.

Important!

- Be careful not to damage the irradiation part on the bottom of the unit when cleaning the LED UV. If the dirt or shading on the irradiation part exceeds a certain limit, it may cause banding due to poor curing of the ink.





4.4 When Nozzle Clogging Cannot Be Solved

If the nozzle clogging is not resolved even after head cleaning  "Head Cleaning"(P. 66) is implemented, execute the following functions.

HEAD FILLUP	<ul style="list-style-type: none"> Fill the head with ink. Filling with ink from the sub tank to the head
NOZZLE WASH	<ul style="list-style-type: none"> Wash the head nozzle.  "Washing of head nozzle"(P. 135)
NOZZLE RECOVERY	<ul style="list-style-type: none"> If you cannot fix the nozzle clogging, print using an alternative nozzle.  "NOZZLE RECOVERY Function"(P. 144)

Filling with ink from the sub tank to the head

1 Select [HEAD FILLUP] from the [MAINTENANCE] menu.

- (1) Press the [FUNCTION] key in LOCAL.
- (2) Press   to select [MAINTENANCE], and press the [ENTER] key.
- (3) Press   to select [HEAD FILLUP].
- (4) Press the [ENTER] key.

2 Press the [ENTER] key.

SELECT SUBTANK
:CMYKYMCCICIWW

3 Press the [ENTER] key.

** MOVING NOW **
PLEASE WAIT

4 Press the [ENTER] key.

- The ink starts to be filled in the head.

FILL UP
PLEASE WAIT

- Once the filling is complete, the following screen is displayed.

HEAD FILLUP
COMPLETED< >RETRY

5 Press to select "COMPLETED".

- When refilling, press  and perform the operations from Step 2 onwards.

6 Press the [END] key several times to end the operation.

Washing of head nozzle

Wash the head nozzle to prevent them from getting clogged due to the hardened ink.

Check these items in advance

Is [INK END] displayed?

- The ink is absorbed during washing. If the ink end is detected at this time, washing cannot be performed.
- Replace the ink bottle with another one for which ink end has not been detected.

1 Press the [MAINT.] key in LOCAL.

CARRIAGE OUT

[ENT]

2 Press ▲ ▼ to select [NOZZLE WASH].

NOZZLE WASH

[ENT]

3 Press the [ENTER] key.

- Carriage moves.

WIPER CLEANING

COMPLETED (NEXT) [ENT]

Important!

- [COMPLETED (NEXT): ENT] is displayed on the screen until the cleaning work of wiper is complete. Press the [ENTER] key after Step 4 is complete. If you press the [ENTER] key before the cleaning is complete, the machine moves to the next washing step.

4 Clean the wiper and the bracket.

- (1) Open the right maintenance cover, hold the protrusions at both the ends of the wiper and pull it out.
- (2) Use a clean stick soaked in washing liquid.
 - Wipe it off properly so that there is no residual washing liquid.
- (3) Hold the wiper by the protrusions at both the ends and push it back to the original position.

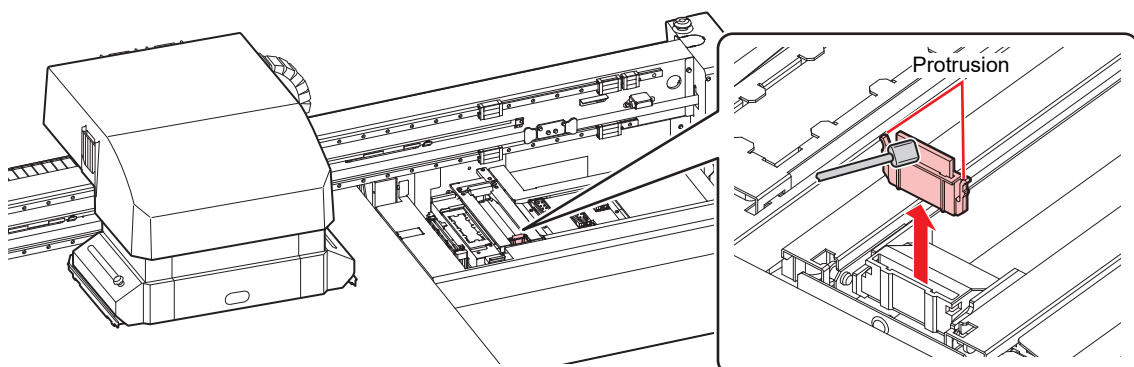

5 Press the [ENTER] key.

CAP CLEANING

COMPLETED (NEXT) [ENT]



- [COMPLETED (NEXT): ENT] is displayed on the screen until the cleaning of the cap is complete. Press the [ENTER] key after Step 6 is complete. If you press the [ENTER] key before the cleaning is complete, the machine moves to the next washing step.

6 Clean the cap rubber and cap rubber cover.

- Wipe off any ink on the cap rubber and the cap rubber cover using a clean stick soaked in washing liquid. Wipe it off properly so that there is no residual washing liquid.
- At this time, the discharge passage is cleaned automatically.

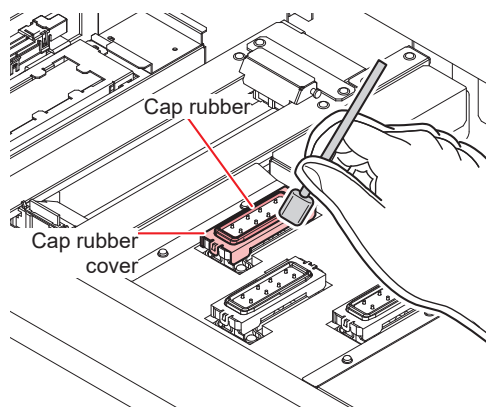

7 Press the [ENTER] key.

FILL THE LIQUID.
COMPLETED (NEXT) [ENT]



- [COMPLETED (NEXT): ENT] is displayed on the screen until the washing liquid is filled. Press the [ENTER] key after Step 8 is complete. If you press the [ENTER] key before the washing liquid is filled, the carriage returns to its original position.

8 Take washing liquid in a dropper and fill the cap with it until it is full.

- Fill the cap with washing liquid until it is about to overflow.

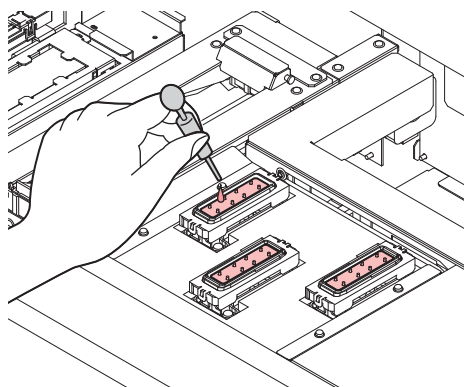

9 Press ▲ ▼ to enter the leaving time. (Supported from firmware version 2.6 onward)

- When using ML007 maintenance liquid: Recommended time is 1 minute.
- When using ML016 maintenance liquid: Recommended time is 10 minutes depending on nozzle condition.

10 Press the [ENTER] key.

- This will absorb the washing liquid filled in the cap.
- The screen on the right is displayed while the cleaning liquid is still left in the cap.
- After the duration has passed, the display returns to Step 2.

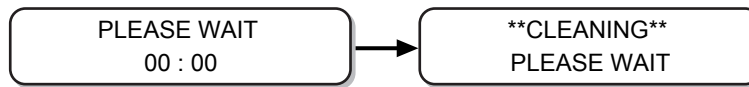

Important!

- If the missing nozzle is not resolved even after cleaning multiple times, contact your local distributor, or our sales office or call center.

Washing the Head Nozzle (When Using the PR-200 INK)

On models equipped with the PR-200, ink may clog the nozzle. Please check the version on the label of the PR-200 ink cartridge, pack, or bottle, and clean the nozzle. Please clean the nozzle twice a week for Ver.2 and once a month for Ver.3.

Label Ver. notation position	
220ml Cartridge	250mL Bottle
600mL Pack	1L Bottle
Maintenance liquid required	<ul style="list-style-type: none"> • F-200/LF-200 Maintenance liquid (SPC-0568) • PR-200 Maintenance liquid (C-ML013-Z-B2-1-KW)

1 Press the [MAINT.] key in LOCAL.

CARRIAGE OUT

[ENT]

2 Press ▲ ▼ to select [NOZZLE WASH].

NOZZLE WASH

[ENT]

3 Press the [ENTER] key.

- Carriage moves.

WIPER CLEANING
COMPLETED (NEXT) [ENT]

- Important!** • [COMPLETED (NEXT): ENT] is displayed on the screen until the cleaning work of wiper is complete. Press the [ENTER] key after Step 4 is complete. If you press the [ENTER] key before the cleaning is complete, the machine moves to the next washing step.

4 Clean the wiper and the bracket.

- (1) Open the right maintenance cover, hold the protrusions at both the ends of the wiper and pull it out.
- (2) Use a clean stick soaked in the F-200/LF-200 maintenance Liquid (SPC-0568).
 - Wipe it off properly so that there is no residual F-200/LF-200 Washing Liquid.
- (3) Hold the wiper by the protrusions at both the ends and push it back to the original position.

- Important!** • When cleaning the wiper, bracket, cap rubber, and cap rubber cover, be sure to use the F-200/LF-200 maintenance liquid, and do not use the PR-200 maintenance liquid (CML013-Z-B2-1-KW).

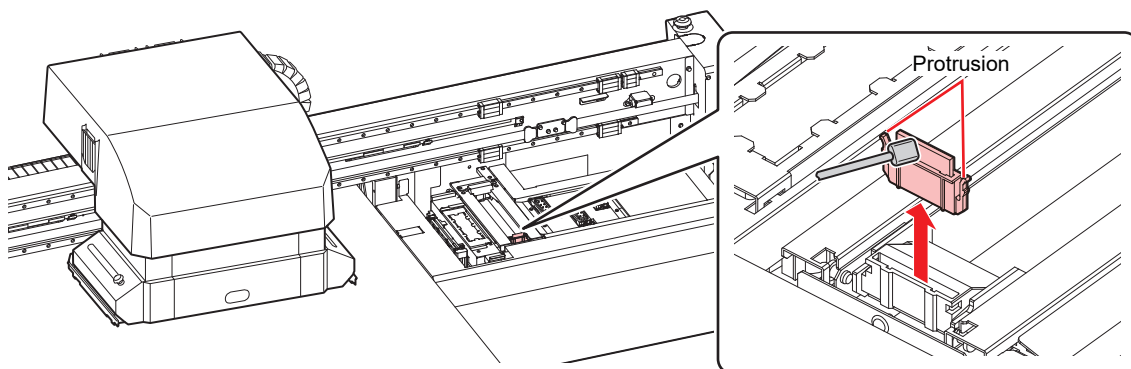

5 Press the [ENTER] key.

CAP CLEANING
COMPLETED (NEXT) [ENT]

- Important!** • [COMPLETED (NEXT): ENT] is displayed on the screen until the cleaning of the cap is complete. Press the [ENTER] key after Step 6 is complete. If you press the [ENTER] key before the cleaning is complete, the machine moves to the next washing step.

6 Clean the cap rubber and cap rubber cover.

- Wipe off any ink on the cap rubber and the cap rubber cover using a clean stick soaked in the F-200/LF-200 maintenance liquid. Wipe it off properly so that there is no residual F-200/LF-200 maintenance liquid.
- At this time, the discharge passage is cleaned automatically.

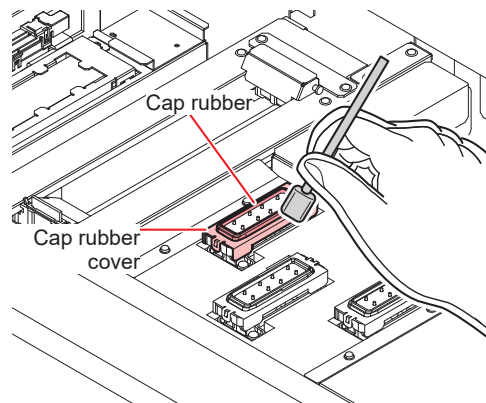

7 Press the [ENTER] key.

FILL THE LIQUID.
COMPLETED (NEXT) [ENT]

Important!

- [COMPLETED (NEXT): ENT] is displayed on the screen until the washing liquid is filled. Press the [ENTER] key after Step 8 is complete. If you press the [ENTER] key before the maintenance liquid is filled, the carriage returns to its original position.

8 Take the PR-200 maintenance liquid (C-ML013-Z-B2-1-KW) in a dropper and fill only the cap of the head equipped with PR-200 with it until it is full.

- Fill the cap with washing liquid until it is about to overflow.

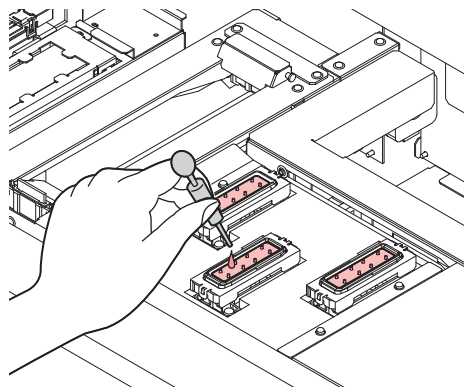

9 Press ▲ ▼ to enter the leaving time. (Supported from firmware version 2.6 onward)

- The recommended leaving time is 1 minute.

10 Press the [ENTER] key.

- This will absorb the washing liquid filled in the cap.
- The screen on the right is displayed while the cleaning liquid is still left in the cap.
- After the duration has passed, the display returns to Step 2.



11 Execute head cleaning (HARD) once for the head equipped with PR-200.

- (1) Press the [END] key to display the LOCAL screen.
- (2) Press the [CLEANING] key, then press ▲▼ to select CLEANING: HARD, and press the [ENTER] key.
- (3) In SELECT HEAD, press ▲▼ to select only Head 3, and press the [ENTER] key.

```
SELECT HEAD
__ 3
```

12 Check the nozzle status by performing a test print.

- When the nozzle clogging occurs, execute nozzle cleaning (HARD) again then check the nozzle status.



- If the nozzle clogging is not resolved even after repeating this cleaning 3 times, contact your local distributor, or our sales office or call center.

Performing Air Purge

If the nozzles are clogged due to mixing of colors or air in the ink in the head, release the ink in the head or the mixed air from the port.



- We recommend that you implement air purge about once a month to prevent nozzle clogging before it happens, so that the machine can be used comfortably.

1 Select [AIR PG.] from the MAINTENANCE menu.

- (1) Press the [FUNCTION] key in LOCAL.
- (2) Press ▲▼ to select [MAINTENANCE], and press the [ENTER] key.
- (3) Press ▲▼ to select [AIR PG.].

2 Press the [ENTER] key.

```
SELECT AIR PG
1<          3v          >2
```

3 Press ◀▶ to select the port to purge the air.

- ◀: Select the left port
- ▼: Select the central port
- ▶: Select the right port
- After the Y-bar moves all the way to the front, the carriage moves above the wiper.
- Press the [ENTER] key to stop it at that position.

```
MOVING NOW  →  SET TOOL
PLEASE WAIT  START  [ENT]
```

4 Open the maintenance cover.

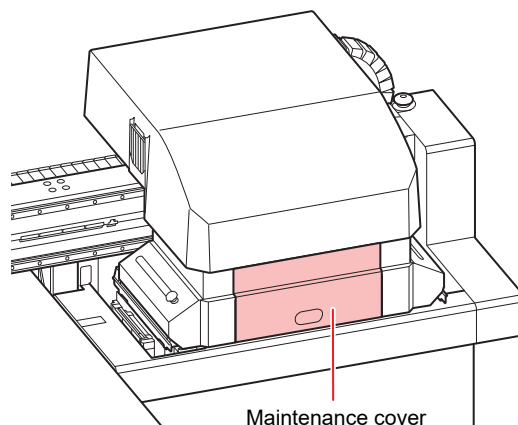

- Important!** • After the work is complete, quickly attach the removed cover. If you leave it removed for a long time, ultra-violet rays may affect the ink.

5 Press the [ENTER] key.

SET TOOL
COMPLETED [ENT]

- Important!** • [COMPLETED: ENT] is displayed on the screen until the air vent jig is set up. Press the [ENTER] key after the work up to Step 8 is complete.

6 Remove the cap of the target port.

- Port layout is shown in the following figure.

	Head 1	Head 2	Head 3
4-Color + W + CI	C Y M K	Y M K C	CI W CI W
4-Color + W + Pr + CI	C Y M K	Y M K C	Pr W CI W
4-Color + W (When using this ink set, OPT-J499 is required.)	C Y M K	Y M K C	W W W W

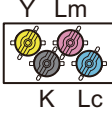
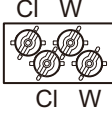
6-Color + W			
-------------	---	--	---

- Turn the cap 30° counterclockwise and then remove it.
- Ink is stuck on the removed cap. Temporarily place it on a paper towel, etc. to avoid contamination of the surrounding area.
- Perform air purge for each head. Do not remove the caps of head 2, head 3 when performing air purge for head 1.

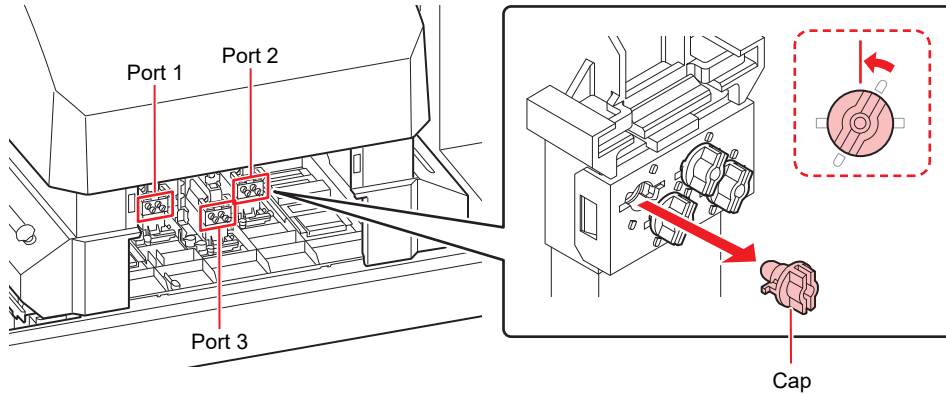

- The internal mechanism does not let the ink spill out even if the cap is removed.

7 Connect the jig to the port.

- Similar to the cap, connect the jig by pushing the tip into the port and rotating it clockwise by 30°.

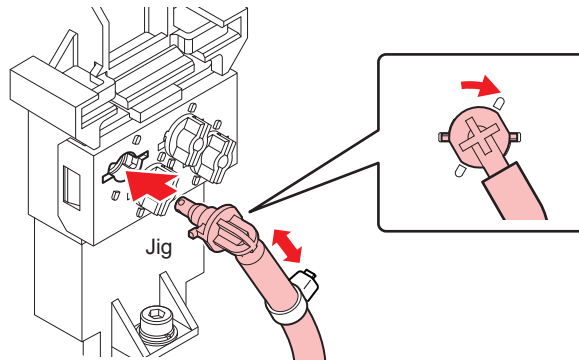

Insert the jig in the wiper part to fix it in place



- There is a magnet attached to the bottle of the air vent jig. When attaching the bottle to the machine, try to place it at the lowest position possible.

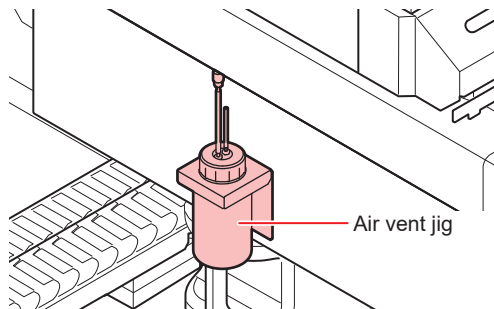

8 Press the [ENTER] key.

AIR PG. START	[ENT]
------------------	-------

9 Release the colored ink or the air mixed in the ink.

- When you press the [ENTER] key, the machine goes into a state of atmospheric release and the ink comes out vigorously.
- Allow it to discharge until the colored ink or the air in the ink is completely gone. Thereafter, ink without any mixed colors will be discharged.
- The buzzer sound goes off at regular intervals while the ink is being discharged.

AIR PG. [DISCHARGE] COMPLETED	[ENT]
----------------------------------	-------

10 Perform Step 9 for all ports from which air is purged.

- The carriage may move quickly at times. Keep your hands, head, or your body away from the carriage.

11 Press the [ENTER] key.

AIR PG. COMPLETED	[ENT]
----------------------	-------

12 Press the [ENTER] key.

REMOVE TOOL START	[ENT]
----------------------	-------

13 Remove the jig and re-attach the cap.

- Re-attach the cap immediately after removing the jig.

14 Once the cap is re-attached, press the [ENTER] key.

- Negative pressure control restarts and wiping begins.

REMOVE TOOL COMPLETED [ENT]	→	PLEASE WAIT
--------------------------------	---	-------------

15 Press ▲ ▼ to select "COMPLETED" or "RETRY".

- If you select "COMPLETED" cleaning is performed. Once the cleaning is complete, Return to the [AIR PG.] screen of step 1.
- If you select "RETRY", return to the screen of step 5. Perform the air bleeding operation for the port that has not completed air bleeding for the head selected in step 3.

AIR PG. COMPLETED< >RETRY

16 Press the [END] key several times to end the operation.**17** Close the maintenance cover.



- After the work is complete, quickly attach the removed cover. If you leave it removed for a long time, ultra-violet rays may affect the ink.

NOZZLE RECOVERY Function

If nozzle clogging cannot be improved at the specified points, other good nozzles can be used as alternatives (nozzle recovery) for printing.

The structure of the head is as shown in the following figure.

With the nozzle recovery function, you can set nozzle recovery by specifying the nozzle lines for H1-3 (heads 1-3) respectively.

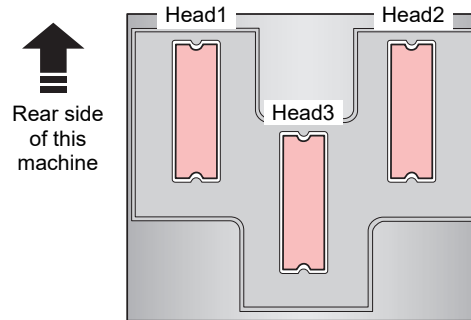

- The machine is equipped with four nozzle lines (A, B, C, and D) for each head.

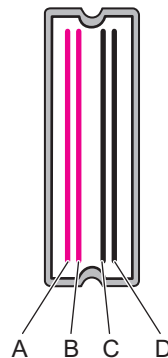

1 Select [NOZZLE RECOVERY] of the MAINTENANCE menu.

- (1) Press the [FUNCTION] key in LOCAL.
- (2) Press ▲ ▼ to select [MAINTENANCE], and press the [ENTER] key.
- (3) Press ▲ ▼ to select [NOZZLE RECOVERY].
- (4) Press the [ENTER] key.

2 Press ▲ ▼ to select [PRINT], and press the [ENTER] key.

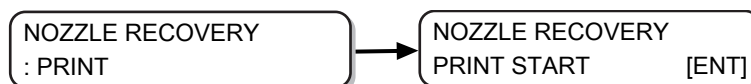

3 Press the [ENTER] key to start printing.

- The nozzle pattern is printed.
- When you select [ENTRY] in Step 2, the machine moves to the nozzle line selection step (Step 5) without printing the nozzle pattern.

PRINT
PLEASE WAIT

- Nozzle pattern

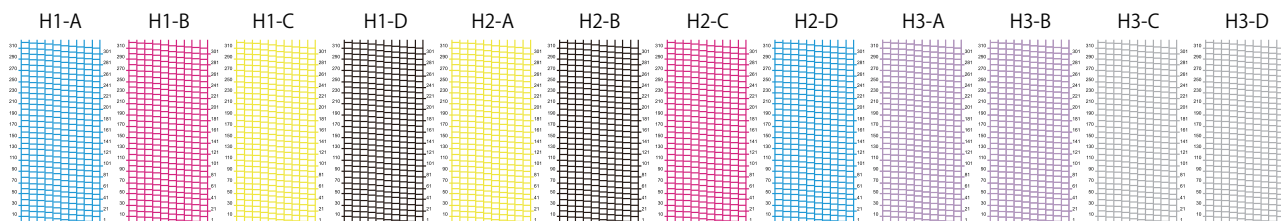

4 Press ▲ ▼ to select the nozzle line that needs nozzle recovery, and press the [ENTER] key.

SELECT NOZZLE
: H1-A

Nozzle line: A, B, C, D

Head No.: H1 to H3

5 Register the nozzle number that needs nozzle recovery, and press the [ENTER] key.

H1-A
No. 1: 184

Recovery nozzle No.
(1 to 320) or OFF

Registration No.: 1 to 10

- (1) Press ▲ ▼ to select the registration number (from 1 to 10), and press the [ENTER] key.
- (2) Press ▲ ▼ to register the nozzle number that needs recovery, and press the [ENTER] key.

- Example of registration of nozzle for recovery

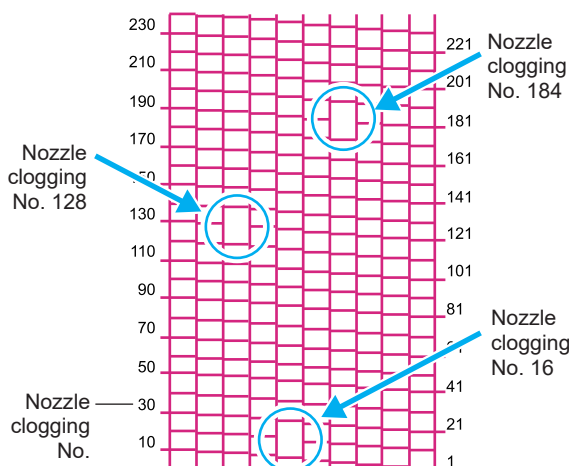

Registration No.	Recovery nozzle No.	Status
1	16	Target for nozzle recovery
2	128	Target for nozzle recovery

3	184	Target for nozzle recovery
4	OFF	No registration
5	OFF	No registration

6 Press the [END] key several times to end the operation.



- Up to 10 nozzles can be registered for each nozzle line.
- Time required for printing does not change even if you use this function.
- The nozzle recovery function is invalid for the lowest number of paths in the printing conditions.
- Even if you register nozzle recovery, the pattern of test print and the likes is not recovered.



- When using white ink, print on clear film to check.

Check if the registered nozzle is recovered

You can check if the registered nozzle has been successfully recovered.

With the following settings "ON" you can print a test pattern using the recovered nozzle when running a test print "Test printing"(P. 62).

1 Select [NOZZLE RECOVERY] of the MAINTENANCE menu.

- (1) Press the [FUNCTION] key in LOCAL.
- (2) Press to select [MAINTENANCE], and press the [ENTER] key.
- (3) Press to select [NOZZLE RECOVERY].
- (4) Press the [ENTER] key.

2 Press to select [CONFIRM MENU], and press the [ENTER] key.

NOZZLE RECOVERY
: CONFIRM MENU

3 Press to select "ON" and press the [ENTER] key.

CONFIRM MENU
: ON

4 Press the [END] key several times to end the operation.



- If you wish to run a test print with the recovered nozzle registered in nozzle recovery, select "ON" in Step 3 of "Test printing"(P. 62).

Before starting the printing operation, check whether there is a nozzle that cannot be recovered

Depending on the printing conditions that have been set, there are times when nozzle cannot be recovered even if [NOZZLE RECOVERY] is registered.

With this setting, you can check if the nozzle is recoverable before printing, and select the applicable operation for non-recoverable nozzle.

1 Select [NOZZLE RECOVERY] of the MAINTENANCE menu.

- (1) Press the [FUNCTION] key in LOCAL.
- (2) Press ▲ ▼ to select [MAINTENANCE], and press the [ENTER] key.
- (3) Press ▲ ▼ to select [NOZZLE RECOVERY].
- (4) Press the [ENTER] key.

2 Press ▲ ▼ to select [CHECK BEFORE PRINT], and press the [ENTER] key.

NOZZLE RECOVERY
: CHECK BEFORE PRINT

3 Press ▲ ▼ to select a setting, and press the [ENTER] key.

- Available settings:
OFF, CONTINUE, STOP

CHECK BEFORE PRINT
: OFF

- OFF:
Do not check before printing.
- CONTINUE:
Check before printing. If recovery is not possible, the following screen is displayed for three seconds and after that the printing starts.

1200 x 1200 32P Hi Bi
UNRECOVERABLE

- STOP:
Check before printing. If recovery is not possible, print confirmation screen is displayed. Press the [ENTER] key to print.

1200 x 1200 32P Hi Bi
UNRECOVERABLE [ENT]

4 Press the [END] key several times to end the operation.**Clear the settings****1 Select [NOZZLE RECOVERY] of the maintenance menu.**

- (1) Press the [FUNCTION] key in LOCAL.
- (2) Press ▲ ▼ to select [MAINTENANCE], and press the [ENTER] key.
- (3) Press ▲ ▼ to select [NOZZLE RECOVERY].
- (4) Press the [ENTER] key.

2 Press ▲ ▼ to select [CLEAR], and press the [ENTER] key.

NOZZLE RECOVERY
: CLEAR

3 Press ▲ ▼ to select the nozzle line that needs to be reset, and press the [ENTER] key.

SELECT RESET NOZZLE
: H1-A

H1-A CLEAR?
EXECUTE [ENT]

4 Press the [ENTER] key.

5 Press the [END] key several times to end the operation.

4.5 Automatic Maintenance Function

To use this machine comfortably, you can set the various maintenance functions to be run automatically. Here, set performing intervals of various automatic maintenance functions.

Issues such as ink clogging can be avoided by performing automatic maintenance periodically. (Automatic maintenance function)

For automatic maintenance function, you can make the following settings.

- Important!**
- When maintenance is performed manually, after it is complete and when the time set with the automatic maintenance function has passed, maintenance starts automatically.

Function name	Description
REFRESH	The interval between each refresh operation is set.
CLEANING	Cleaning type and the interval between each cleaning operation are set.

- Important!**
- When the message on the right is displayed, the operation set in the automatic maintenance function is not carried out. Perform the operations of  "Disposing of Waste Ink"(P. 155) as required.





<LOCAL>
Check waste ink [MNT]

- When the power button on the front of the machine is turned off, check the waste ink tank.

Setting the refresh intervals

An interval is set between each operation of ejecting small amount of ink from the nozzles to prevent nozzle clogging.

1 Select [AUTO MAINT.] of the MAINTENANCE menu.

- Press the [FUNCTION] key in LOCAL.
- Press   to select [MAINTENANCE], and press the [ENTER] key.
- Press   to select [AUTO MAINT.].

2 Press the [ENTER] key.

AUTO MAINT.
REFRESH [ENT]

3 Press the [ENTER] key.

REFRESH
: Lv. 1

4 Press to set the refresh intervals

- Available settings: OFF, Lv.1, Lv.2, Lv.3

REFRESH
: Lv. 2

5 Press the [ENTER] key.

AUTO MAINT.
REFRESH [ENT]

6 Press the [END] key several times to end the operation.

Setting the Cleaning Interval

Cleaning type and the interval between each cleaning operation are set.

1 Select [AUTO MAINT.] of the MAINTENANCE menu.

- (1) Press the [FUNCTION] key in LOCAL.
- (2) Press ▲ ▼ to select [MAINTENANCE], and press the [ENTER] key.
- (3) Press ▲ ▼ to select [AUTO MAINT.].
- (4) Press the [ENTER] key.

2 Press ▲ ▼ to select [CLEANING].

AUTO MAINT.
CLEANING [ENT]

3 Press the [ENTER] key.

CLEANING
: Lv. 1

4 Press ▲ ▼ to set the interval between each cleaning operation.

- Available settings: OFF, Lv.1, Lv.2, Lv.3
- As the level increases, the interval between each operation becomes shorter.

CLEANING
: Lv. 2

5 Press the [ENTER] key.

- When you set a value other than "OFF" in Step 4, the cleaning type selection screen is displayed.

TYPE
: NORMAL

6 Press ▲ ▼ to select a cleaning type.

- Available settings: NORMAL, SOFT, HARD

TYPE
: SOFT

7 Press the [ENTER] key.

AUTO MAINT.
CLEANING [ENT]

8 Press the [END] key several times to end the operation.

4.6 Replacement of Consumables

To order replacement consumable items, contact your local dealer or our service office.
For more information on consumable items, refer to our website.
<https://mimaki.com/supply/inkjet.html>

Replacing the wiper

The wiper is a consumable good. If the message on the right is displayed, replace the wiper as soon as possible.

Also, wipe the ink sticking to the lower surface of the slider.

<LOCAL>
REPLACE WIPER [MNT]

Important! • Cleaning wipers are sold separately. Purchase one from your local distributor or our sales office.

1 When the message is displayed, press the [ENTER] key.

REPLACE WIPER
EXECUTE [ENT]

2 Press the [ENTER] key.

- Carriage moves onto the table.

REPLACE WIPER
COMPLETED [ENT]

Important! • [COMPLETED :ENT] is displayed on the screen until the replacement work is completed.
Press the [ENTER] key after the work up to Step 4 is complete.

3 Remove the wiper

- Pull out the wiper by holding the protrusions at both the ends.

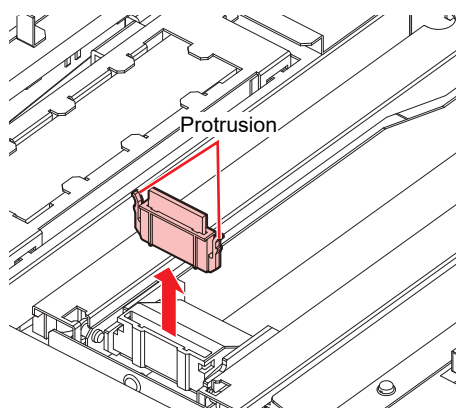

4 Insert a new wiper

- Insert the wiper by holding the protrusions at both the ends.

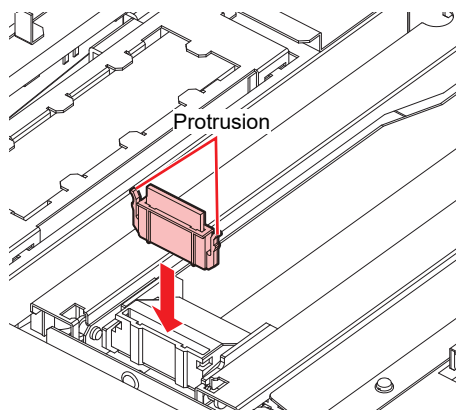

5 Press the [ENTER] key.

- After its initial operation, the machine returns to LOCAL.

Being Initialized
PLEASE WAIT

Replacing Carriage Filters

Replace the filters once every 1 or 2 weeks.

1 Move the carriage.

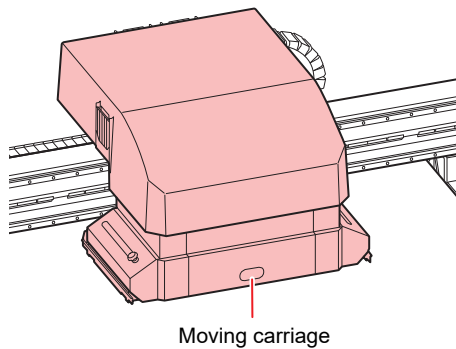

2 Remove the used carriage filter.

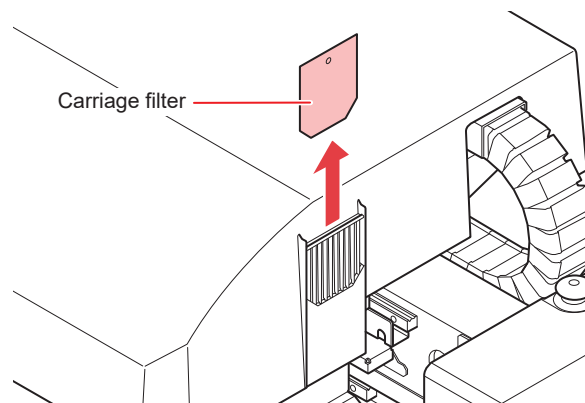

3 Install the new carriage filter (PN : SPC-0851).

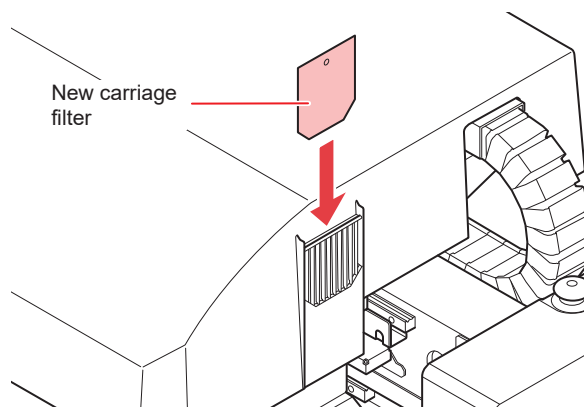

- Important!**
- Carriage filters are on the left, right, and back side of the carriage. Replace all the filters at same time.

4 Once the replacement is complete, press the [ENTER] key.

Disposing the Waste Ink

The ink used in head cleaning and other functions is stored in the waste ink tank on the lower right side of the machine. The machine counts the accumulated amount of discharged ink, and a message is displayed prompting the user to check the tank once the specified amount is reached. Consider replacing the waste ink tank when this message is displayed.



- The message is displayed when the amount of discharged ink reaches 80% (2.1 L) of the 2.6 L tank.

Confirmation message in LOCAL

1 The message on the right is displayed.

```
<LOCAL>
Check waste ink      [MNT]
```

2 Check the waste ink tank.

- If the displayed amount is different from the actual amount, press ▲ ▼ to correct.
- If you correct the amount to less than 80% and press the [ENTER] key, the message disappears.
- When replacing (disposal) and clearing the count, perform the following procedure.
 - ☞ ["Disposing of Waste Ink"\(P. 155\)](#)

```
Check waste ink
Level : 80% (2.1L)
```

- Important!**
- Discard waste ink frequently. The waste ink might start overflowing from the waste ink tank if you simply delete the message by pressing the [ENTER] key and continue using the printer without disposing of the waste ink.

Disposing of Waste Ink



- When disposing of the waste ink from the waste ink tank, be sure to wear the included safety glasses and gloves. Otherwise you may get ink in your eyes.



Important!

- Do not replace the waste ink tank while this machine is in operation (printing or cleaning).
- If waste ink overflows during work, wipe it off with a waste cloth.

1 Open waste ink tank cover.

- Remove the screws on the waste ink tank cover, and open the cover to the front.

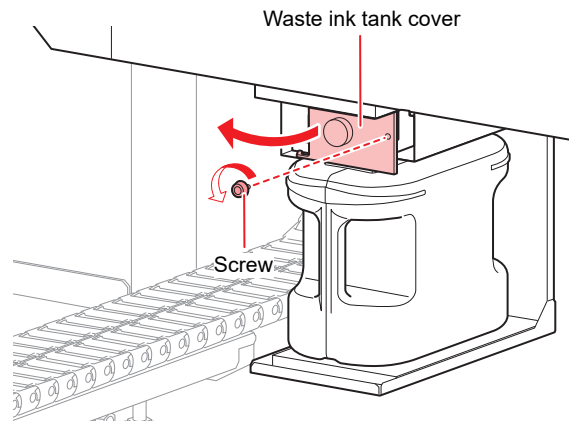

2 Remove the waste ink tank.

- Hold the handle of the waste ink tank and pull it to the front.
- Put a cap on the waste ink tank removed.

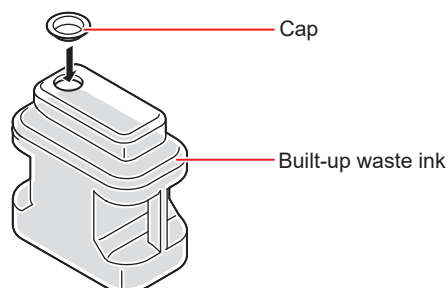
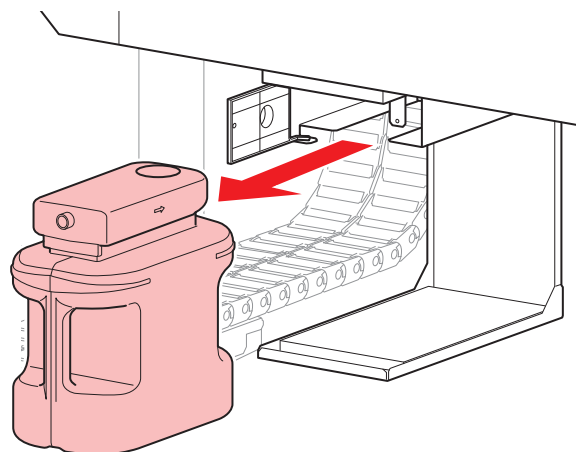

3 Replace the waste ink tank.

- (1) Prepare a new waste ink tank.
- (2) Insert by holding the handle of the waste ink tank.
- (3) Lift the waste ink tank and check that it is set just below the drain port.

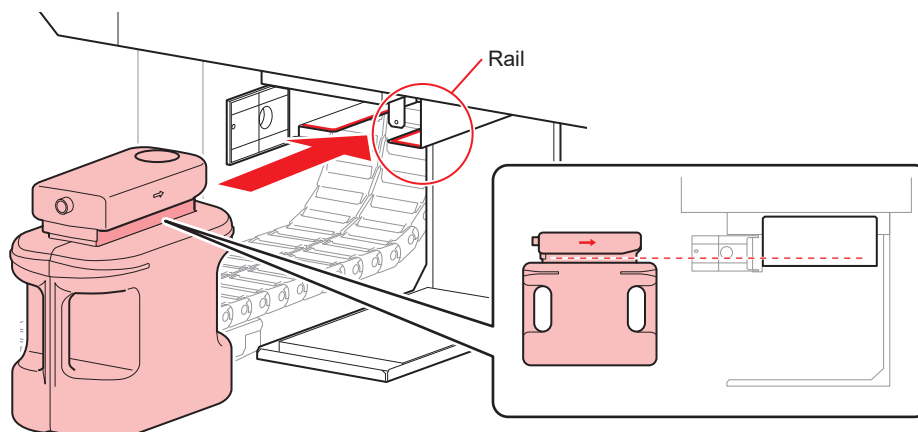

- Request an industrial waste processor to process the waste ink.
- Some of the components of (photopolymerization initiator) waste ink are poisonous to aquatic organisms. Prevent leakage flow to natural water bodies (such as rivers) and domestic sewages (such as toilets, roads).

4 Close the waste ink tank cover.

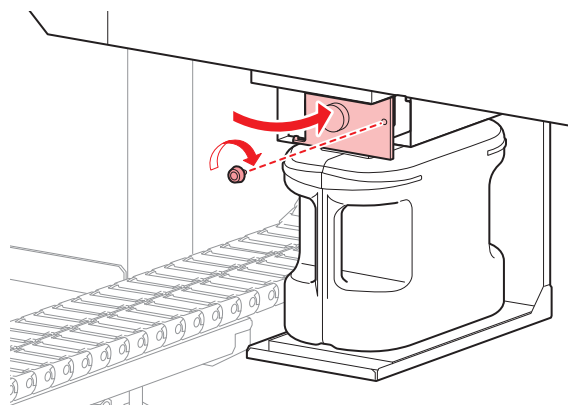

5 Select [InkTankExchange] from the MAINTENANCE menu.

- (1) Press the [FUNCTION] key in LOCAL.
- (2) Press ▲ ▼ to select [MAINTENANCE], and press the [ENTER] key.
- (3) Press ▲ ▼ to select [InkTankExchange].

```

MAINTENANCE
InkTankExchange [ENT]
  
```

6 Press the [ENTER] key to release.

```

InkTankExchange
EXCHANGE [ENT]
  
```

Replacing the waste ink tank before the waste ink tank confirmation message is displayed (1)

When replacing the waste ink tank before the waste ink tank confirmation message is displayed (before reaching 80% (2.1 L) of the 2.6 L tank), set the waste ink information to 0% on the INFORMATION menu.

1 Empty the waste ink tank.

-  ["Disposing of Waste Ink"\(P. 155\)](#)

2 Press the [FUNCTION] key in LOCAL.

```
FUNCTION
SETUP [ENT]
```

3 Press to select [INFORMATION].

- For firmware version 1.90 or later, you can also run this procedure from the MAINTENANCE menu. For procedure from [MAINTENANCE], see  ["Replacing the waste ink tank before the waste ink tank confirmation message is displayed \(2\)"\(P. 157\)](#).

```
FUNCTION
INFORMATION [ENT]
```

4 [ENTER] Press the key.

```
INFORMATION
USAGE [ENT]
```

5 Press to select [USAGE].

6 Press the [ENTER] key several times to display the waste ink tank information.

```
WASTE INK TANK
= 60%
```

7 Press the [MAINT.] key.

```
Check waste ink
Level : 60% (1.5L)
```

8 Press to set the "Level" to "0%".

```
Check waste ink
Level : 0% (0.0L)
```

9 Press the [ENTER] key.

Replacing the waste ink tank before the waste ink tank confirmation message is displayed (2)

Set the waste ink information to 0% in the MAINTENANCE menu.

1 Empty the waste ink tank.

-  "Disposing of Waste Ink"(P. 155)

2 Press the [FUNCTION] key in LOCAL.

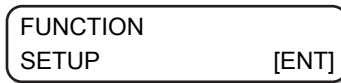

3 Press   to select [MAINTENANCE].

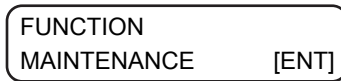

4 Press the [ENTER] key.

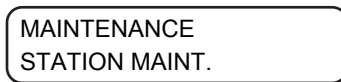

5 Press   to select [InkTankExchange].

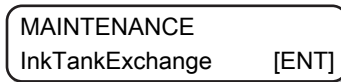

6 Press the [ENTER] key.

- When you press the [ENTER] key, the waste ink information becomes 0%.

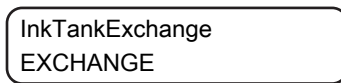

Running this menu will give the same result as when 0% is set in [USAGE] as shown on the previous page.

4.7 About Refilling the Cooling Water

To cool the LED UV unit, put anti freezing liquid mixed with water into the cooling water tank in the cooling device.

The water and anti freezing liquid (PN : SPC-0394) ratio should be 2 (water) to 1 (antifreeze).

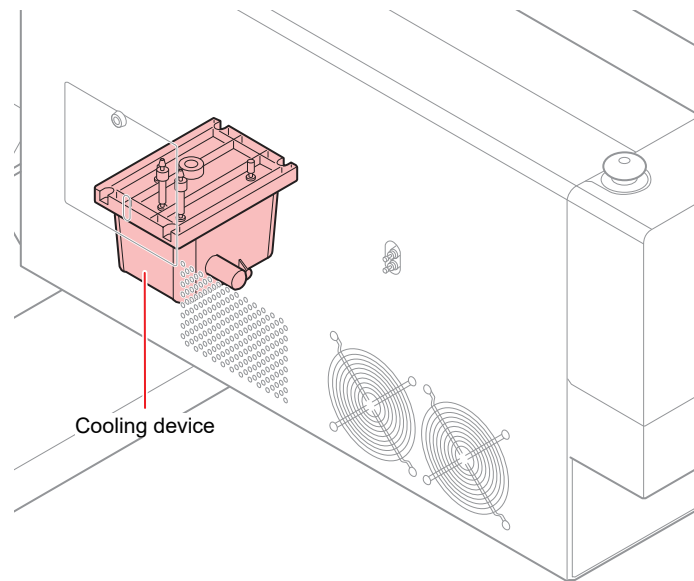

● Notes on refilling



- The water and antifreeze solution ratio should be 2 (water) to 1 (antifreeze).
- If only water is put in the cooling water tank without adding the antifreeze liquid, the LED UV unit may malfunction due to freezing.
- If only antifreeze liquid is supplied to the cooling water tank without water, the machine will not work properly and errors may occur.
- If you notice frequent water shortage in the cooling water tank, contact your local distributor, or our sales office or call center.



- Dispose of the wastewater mixed with antifreeze pursuant to the regulations of your region.



- Antifreeze mixture precautions
 - (1) Be sure to use water that satisfies the following conditions.
 - Calcium content: Not exceeding 10 mg/L (1 mg/100 ml)
 - Hardness: Not exceeding 60 mg/L
 - Distilled or purified water
 - (2) Do not use antifreeze mixture that has been prepared far in advance.
 - (3) Any excess antifreeze mixture must be used within one week. Filling the machine with antifreeze mixture that has been prepared more than one week in advance may lead to a malfunction.

● Precautions for handling antifreeze liquid



- Always use an anti freezing liquid recommended by Mimaki. The cooling device may malfunction if any other product is used. (Supplied antifreeze liquid: 1000 cc x 1)
- Do not touch the antifreeze liquid directly. If you accidentally touch the antifreeze liquid, wash it off immediately with soap and water. If you get antifreeze liquid in your eyes, wash your eyes immediately with plenty of water and consult a physician.
- Store the antifreeze liquid in a cold and dark place.
- Keep the antifreeze liquid out of reach of children.
- Entrust the disposal of the antifreeze liquid you no longer need to an industrial waste disposal contractor and clarify its contents.
- Be sure to read the Safety Data Sheet (SDS) before using antifreeze liquid.



- When handling the anti freezing liquid, be sure to wear the included safety glasses and gloves.



- Prepare a tank with a cap for moving the waste water from the cooling water tank.
- The following error message is displayed when water in the cooling water tank is low. In this case, replace the water in the same way as shown in Refilling the Coolant.

<LOCAL>
WATER LACK

Refilling the Coolant

If the error suggesting lack of water occurs, refill the coolant. Approximately 500 cc of refill is required to fill the tank to its capacity.



- If the tank is not refilled with coolant for a week after the error message suggesting the lack of water, the error display changes to "REFILL WATER". You cannot switch to REMOTE mode while this error is on display. Refill the coolant immediately.

<LOCAL>
REFILL WATER

- A buzzer will continue to sound as long as "REFILL WATER" is displayed.
- If you continue to use the machine in the low water state, the error display will switch to "REFILL WATER" even for a LED-UV temperature error/warning, and it will not be possible to switch to REMOTE mode.

1 Remove the cover of the left rear surface of Y-bar.

- Remove the screw (1 place) indicated with a circle in the figure and remove the cover.

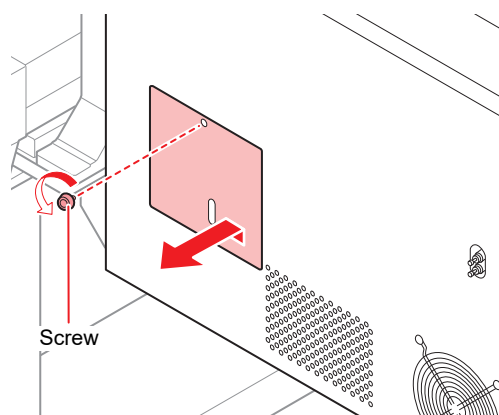

2 Remove the water supply/drainage cap and air purge cap.

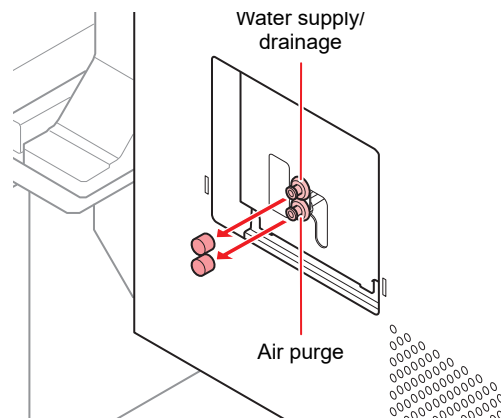

3 Prepare mixed water solution (antifreeze liquid:1, water: 2) in the provided container and fill it into the provided syringe.



4 Fill the mixed water solution until the buzzer sound stops.

- Fill the mixed water solution through the water inlet using a syringe.
- Fill an additional 100 CC after the buzzer stops.

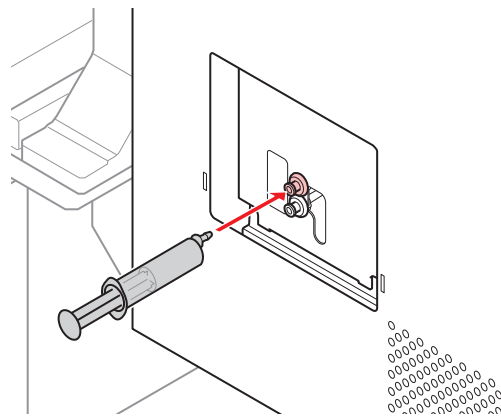

Important!

- The mixed water solution will leak from the tank if you inject it too much.

5 Close the water inlet and air purge, and attach the cover of the left rear side of Y-bar.

4.8 Flushing Filter

Tools required for replacement	• F-200/LF-200 Washing Liquid (PN : SPC-0568)	• Safety glasses
	• Waste cloth	• Gloves



- Be sure to wear the included safety glasses and gloves when performing replacement. As there is ink absorbed in the flushing filter, it may get in your eyes.



Replacing the Flushing Filter

The flushing filter needs to be replaced periodically.

Replace the flushing filter (PN : SPC-0851) if a replacement message as shown in the following figure appears.

- 1** When it is time to replace the flushing filter, the following message appears.

FLUSHING FILTER PLEASE
[ENT]

- 2** Press the [ENTER] key.

- The carriage moves and the following message appears.

EXCHANGE
COMPLETED

- 3** Replace the flushing filter and press the [ENTER] key.

- The carriage returns to the station and the mode returns to LOCAL.

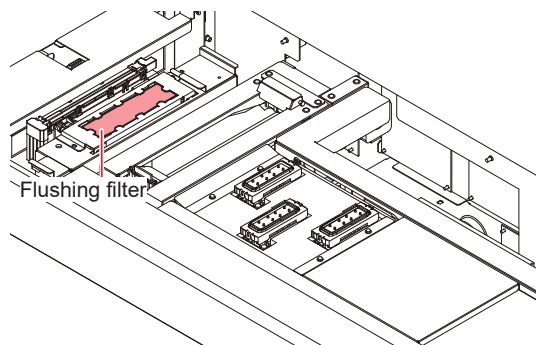

Replacing the flushing filter before the replacement message is displayed

1 Select [STATION MAINT.] of the MAINTENANCE menu.

- (1) Press the [ENTER] key in LOCAL.
- (2) Press ▲ ▼ to select [MAINTENANCE], and press the [ENTER] key.
- (3) Press ▲ ▼ to select [STATION MAINT.].
- (4) Press the [ENTER] key.

2 Press ▲ ▼ to select [FLUSHING FILTER].

STATION MAINT.
FLUSHING FILTER [ENT]

3 Press the [ENTER] key.

CARRIAGE OUT
START [ENT]

4 Press the [ENTER] key.

FILTER REPLACE
COMPLETED [ENT]

Important!

- [COMPLETED :ENT] is displayed on the screen until the filter replacement is complete. Press the [ENTER] key after Step 5 is complete. If you press the [ENTER] key before the replacement is complete, the machine moves to the next procedure.

5 Replace the flushing filter and press the [ENTER] key.

- The carriage returns to the station and the mode returns to LOCAL.

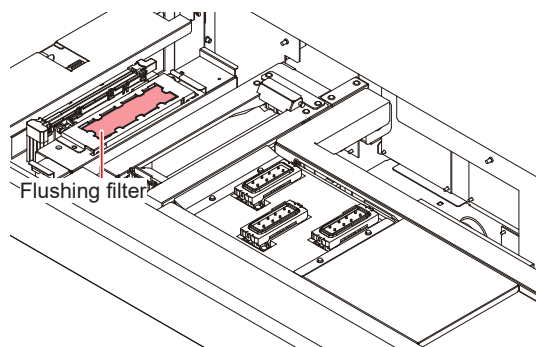

Chapter 5 Troubleshooting



This chapter

Check again before deciding the trouble as malfunction.

Troubleshooting.....	166	If the message "SHAKE WHITE INK	
Power does not turn on.....	166	BOTLES" is displayed.....	168
Machine does not start printing.....	166	If an error related to the sub tank occurs ..	169
Image quality is poor.....	166	If pressure abnormality occurs.....	170
Nozzle is clogged.....	167	Warning/Error Message	172
Ink bottle error.....	167	Warning message	172
Ink leakage.....	168	Error message	175

5.1 Troubleshooting

Check again before deciding the trouble as malfunction. If there is no improvement even after troubleshooting, contact your local distributor, or our sales office or call center.

Power does not turn on

In most of the cases, the power does not turn on due to improper connection of the power cable for the machine or the computer. Check that the power cable is connected properly.

Check points	Implementation
Is the power cable connected to the machine and the power outlet?	Connect the power cable securely if it is not connected.
Is the main power turned on?	Turn the main power on if it is not already on. ☞ "Turning the power on"(P. 53)
Is the power button located at the front of the machine turned on?	If not, press the power button on the front of the machine. ☞ "Turning the power on"(P. 53)

Machine does not start printing

The problem of machine not able to print occurs when the data is not being transmitted to the machine properly.



It may also occur if the printing function does not work properly or the media is not installed correctly.

Check points	Implementation
Is the correct interface cable used?	Use the cable exclusive for this machine.
Is the interface cable connected properly?	Securely connect the interface cable.
Is a message indicating that ink has run out displayed?	Replace the ink bottle with a new one.

Image quality is poor

This section explains the measures to be taken if the print quality is not satisfactory. Take measures according to the cause. If there is no improvement even after troubleshooting, contact your local distributor, or our sales office or call center.

Problem	Solution
White lines/blur/dark lines occur (in the direction of head movement)	<ol style="list-style-type: none"> Execute head cleaning. ☞ "Head Cleaning"(P. 66) Perform maintenance inside the station. ☞ "Maintaining the Capping Station"(P. 120) Clean the dirt, pieces of paper, or any other trash along the area where the head passes.
Misalignment in reversible printing	<ol style="list-style-type: none"> Correct the drop position. ☞ "Correcting the Drop Position"(P. 80)
Ink drips during printing	<ol style="list-style-type: none"> Clean the wiper. ☞ "Cleaning wiper and cap"(P. 120) Clean the ink cap. ☞ "Cleaning wiper and cap"(P. 120)

Problem	Solution
	3. Clean around the head.  "Maintenance of Head Surroundings"(P. 132) 4. Execute head cleaning [NORMAL].  "Head Cleaning"(P. 66) 5. Set a shorter interval for the interval wiping operation.  "Setting Nozzle Surface Cleaning Frequency"(P. 94)

Nozzle is clogged



Nozzle discharge may become unstable depending on the surrounding temperature or if the machine is not used for a long time.

Try the following method to restore the nozzle discharge to normal.

1 Perform maintenance daily.

- Perform maintenance for every spot mentioned in "Maintenance Required".



2 Execute head cleaning (NORMAL).

- Perform head cleaning after completing Step 1.
 "Head Cleaning"(P. 66)
- After that, check the nozzle status by running a test print.
 "Test printing"(P. 62)



- Try the next step if the nozzle clogging problem is not solved.

3 Execute head cleaning (HARD).

- If the nozzle clogging is not resolved even after repeating Normal cleaning, then set the cleaning mode to HARD and perform head cleaning again.
 "Head Cleaning"(P. 66)
- After that, check the nozzle status by running a test print.
 "Test printing"(P. 62)

4 If nozzle is still clogged even after head cleaning, perform the steps in mentioned for the situation where nozzle clogging cannot be restored.

-  "When Nozzle Clogging Cannot Be Solved"(P. 134)



- If the missing nozzle is not resolved even after performing the procedure mentioned above, contact your local distributor, or our sales office or call center.

Ink bottle error

If an ink bottle error is detected, the "red" ink bottle lamp is lit and a warning message is displayed.

None of the operations such as printing and cleaning that discard ink are available.

Perform the following procedure when such an error occurs.

- Check that the ink IC chip in the ink cover is set correctly.
- Replace the ink bottle with a new one immediately.



- Once the ink bottle error is displayed, do not leave the ink bottle without replacing it for a long time. The machine will lose the nozzle clogging prevention function.
 If the nozzles are clogged, contact your local distributor, or our sales office or call center.

Perform the following operation to check the details of the ink bottle error.

1 Press the [ENTER] key in LOCAL mode.

LUS-150	CMWWYKCICI
REMAIN	34567899

2 Press the [ENTER] key.

NON INK IC
CMWWYKCICI

- Details of the ink bottle error are displayed.
- When multiple ink bottle defects occur, they will be displayed in order if you press the [ENTER] key or ◀ ▶.

Ink leakage

If the ink starts leaking, switch off the main power, disconnect the power plug, and contact your local distributor, or our sales office or call center.

If the message "SHAKE WHITE INK BOTLES" is displayed

White ink tends to settle, and hence you must shake the ink bottle periodically.

When using white ink, a message will be displayed periodically prompting you to shake the white ink bottle. Follow the procedure below to shake the white ink bottle.

SHAKE WHITE INK	
BOTTLES	[ENT]

1 Take out the white ink bottle and gently shake it side to side 20 times or more.

- To prevent the ink from leaking when the bottle is shaken, wear hand gloves and close the lid of the ink bottle with a paper towel. Then shake the bottle from side to side at least 20 times to ensure a slow ink flow.



- Make sure that the lid is closed tightly before shaking the bottle.
- The ink may leak outside if you shake the bottle too hard. Shake carefully.
- If only a small amount of ink is remaining, it may not be possible to stir it properly. To stir it properly, tilt the ink bottle until it becomes vertical.

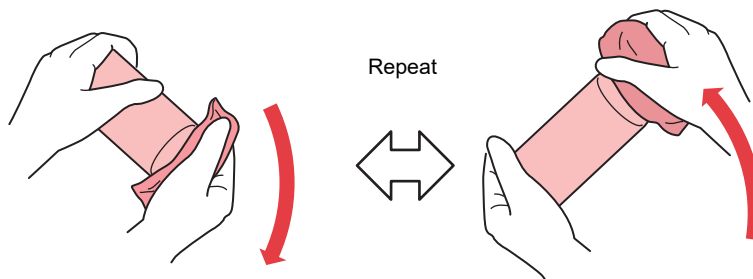

Hold down tightly with a paper towel and shake well

2 Set the ink bottle over the tank, and turn the tank lever from right to left.

- Move the tank lever completely to the right and set the ink bottle.

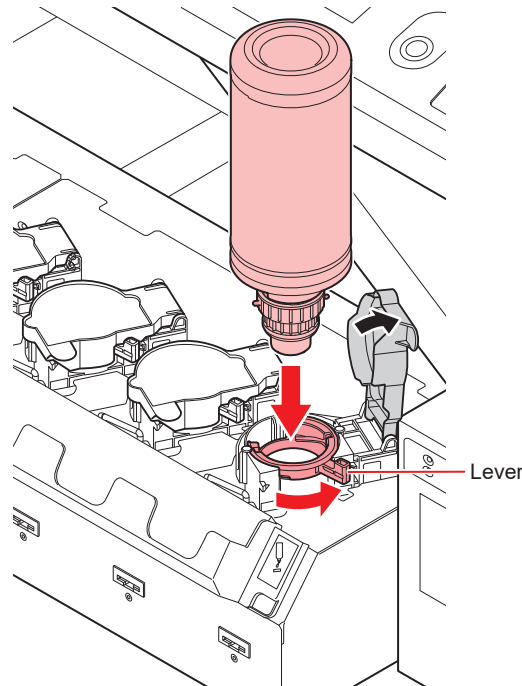

Important! • Never rotate the ink bottle after setting it over the tank. Doing so may result in ink leakage.

3 Press the [ENTER].

If an error related to the sub tank occurs

Errors 618 to 61b are related to the sub tank.

Execute the following procedure when a sub tank error occurs, or when the nozzle is not unclogged after cleaning.

1 Select [SUB TANK] of the MAINTENANCE menu.

- (1) Press the [FUNCTION] key in LOCAL.
- (2) Press ▲ ▼ to select [MAINTENANCE], and press the [ENTER] key.
- (3) Press ▲ ▼ to select [SUB TANK].

2 Press the [ENTER] key.

```
SELECT SUBTANK
:CMYKYMCCICIWW
```

3 Press the [ENTER] key.

```
SUB TANK
EXECUTE [ENT]
```

4 Press the [ENTER] key.

- Automatic discharge and filling operations are performed.

FILL UP
PLEASE WAIT

- Perform cleaning once the filling is complete.

CLEANING
PLEASE WAIT

5 Press the [END] key several times to end the operation.**If pressure abnormality occurs**

The pressure controlled in the machine may exceed the control range due to environment and aging.

If a pressure abnormality occurs, adjust the pressure immediately with the following procedure and return the pressure to its normal value.

1 Select [PRESSURE ADJUST] of the MAINTENANCE menu.

- (1) Press the [FUNCTION] key in LOCAL.
- (2) Press ▲ ▼ to select [MAINTENANCE], and press the [ENTER] key.
- (3) Press ▲ ▼ to select [PRESSURE ADJUST].

2 Press ▲ ▼ to select "POSITIVE" or "NEGATIVE" pressure.

PRESSURE ADJUST
: NEGATIVE

3 Press the [ENTER] key.

Open Throttle Valve
COMPLETED [ENT]

4 Rotate the adjustment screw of the throttle valve to release it so that air can flow.

- Rotate the adjustment screw of the throttle valve until it comes to the middle position.

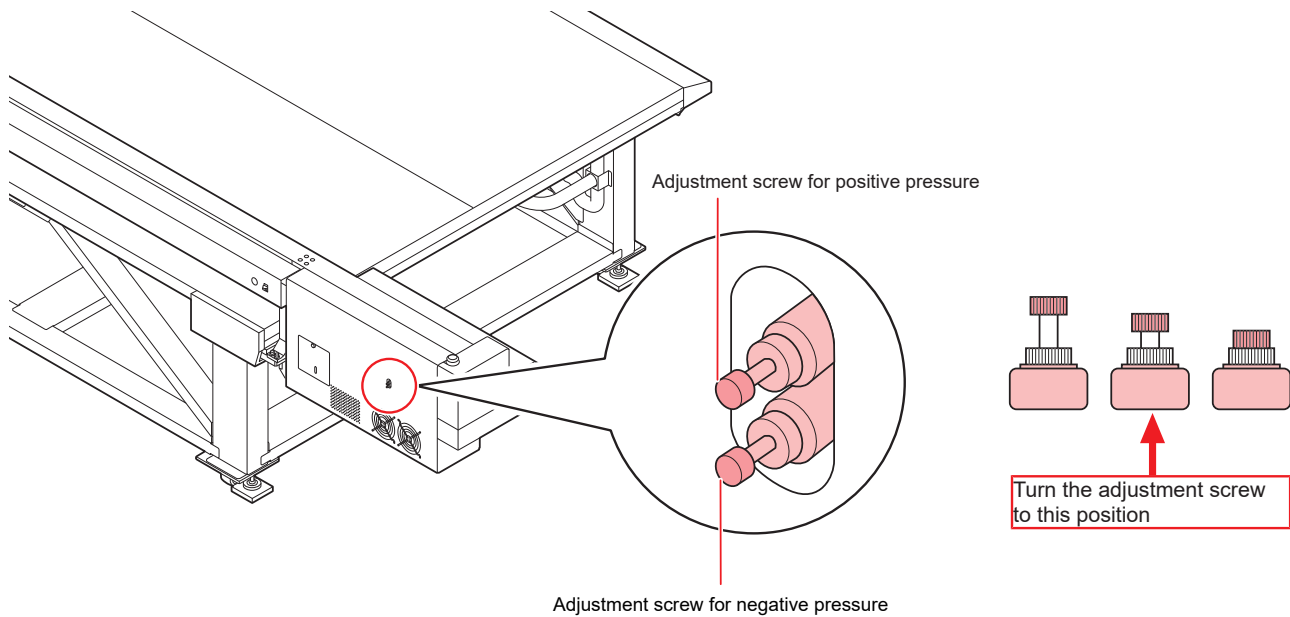

5 Press the [ENTER] key.

- Sensor adjustment starts.

ADJUSTING
PLEASE WAIT

6 Rotate the adjustment screw of the throttle valve to adjust pressure to its proper value.

- Proper value of negative pressure: -2.70 kPa
- Proper value of positive pressure: 15.00 kPa
- Adjust the throttle valve in the order of "negative pressure" -> "positive pressure" -> "negative pressure".
- As the negative pressure changes between ± 0.1 to 0.2 kPa, adjust so that the intermediate value becomes the target pressure.

PRESSURE
= -2.70 kPa

7 Press the [ENTER] key.

- Error is resolved and negative pressure control starts.

PLEASE WAIT



- If an error occurs even after adjusting the pressure, contact your local distributor, or our sales office or call center.

5.2 Warning/Error Message

When an abnormality occurs, the buzzer rings and the display shows a corresponding message.



Take measures according to the message.

Warning message

Errors when performing operations

Message	Cause	Solution
CAN'T OPERATE : INK ERROR	An ink error occurred.	<ul style="list-style-type: none"> Check the ink bottle of the supply path corresponding to the indicated color.
CAN'T OPERATE : DATA REMAIN	Data is being received.	<ul style="list-style-type: none"> Clear the data. ☞ "Deleting the Received Data (Data Clear)"(P. 69)
Replace NCU Ink Pad	The ink absorber needs to be replaced.	<ul style="list-style-type: none"> The NCU ink absorber must be replaced. Contact your local distributor, our sales office, or service center.
NCU error NozzleCheckOFF	An error occurred during the nozzle check. Printing stopped. The nozzle check function was disabled.	<ul style="list-style-type: none"> Contact your local distributor, our sales office, or service center.
REPLACE NCU	A problem was detected with the nozzle clogging assessment.	<ul style="list-style-type: none"> The NCU must be replaced. Contact your local distributor, our sales office, or service center.
NCU Sensor Lv Low	The sensor's sensitivity is impaired.	<ul style="list-style-type: none"> Clean the NCU. ☞ "Cleaning the NCU"(P. 126)
NCU Sens Adj Err H	Sensor sensitivity adjustment failed.	<ul style="list-style-type: none"> Replace the NCU if the error does not clear. Contact your local distributor, our sales office, or service center.
NCU Sens Adj Err L		
NCU CONNECT	A problem was detected with the NCU connection.	<ul style="list-style-type: none"> Turn off the power on the machine and turn it on after a while. ☞ "Turning off the power"(P. 53)
NCU detection error (HW) NozzleCheckOFF	A problem was detected with the nozzle clogging assessment.	Clean the NCU. ☞ "Cleaning the NCU"(P. 126)
NCU NZK CHK (MARK) NozzleCheckOFF		
NCU CENTER POS NozzleCheckOFF	Printing position adjustment failed.	
NCU FLUSH POS NozzleCheckOFF		
NCU SN Adjst error NozzleCheckOFF	Sensor sensitivity adjustment failed.	

Message displayed in LOCAL

Message	Cause	Solution
<LOCAL> CAN'T PRINT/CART. [ENT]	Multiple ink errors (unusable ink). Ink supply (printing, cleaning) cannot be performed.	<ul style="list-style-type: none"> Press the [ENTER] key to check the ink bottle generating the error and the error details. Replace the ink bottle with a usable one.
<LOCAL> Check waste ink[MNT]	Waste ink tank is nearly full.	<ul style="list-style-type: none"> Check the waste ink tank.
<LOCAL> Replace a WIPER [MNT]	Time to replace the wiper in the capping station with a new one. (The wiping count has reached the specified value)	<ul style="list-style-type: none"> Press the [MAINT.] key and replace the wiper with a new one.  "Replacing the wiper"(P. 152)
<LOCAL> DATA REMAIN	The data has been received.	<ul style="list-style-type: none"> Press the [REMOTE] key to perform printing. Or, clear the data.  "Deleting the Received Data (Data Clear)"(P. 69)
<LOCAL> WATER LACK	Water in the cooling water tank is low.	<ul style="list-style-type: none"> Refill the coolant. Refilling the Coolant
<LOCAL> REFILL WATER	Water in the cooling water tank has been low over past 7 days.	<ul style="list-style-type: none"> Refill the coolant. Refilling the Coolant Online printing cannot be performed while this warning is displayed.
<LOCAL> UV LAMP TEMP. HIGH	LED lamp temperature is high.	<ul style="list-style-type: none"> Wait until the temperature lowers and the message disappears.
<LOCAL> NEGATIVE PRESSURE	The value of negative pressure sensor is abnormal.	<ul style="list-style-type: none"> Adjust the pressure.  "If pressure abnormality occurs"(P. 170)
<LOCAL> POSITIVE PRESSURE	The value of positive pressure sensor is abnormal.	<ul style="list-style-type: none"> If the pressure cannot be adjusted to a normal value or if the message is displayed even after executing this step, contact your local distributor, or our sales office or call center.
<LOCAL> INK NEAR END[ENT]	There is a small amount of ink in the supply unit.	<ul style="list-style-type: none"> Press the [ENTER] key to check the corresponding ink bottle. Ink is nearly used up.
<LOCAL> SUPPLY: CMYKYMCCICIWW	Failure to refill ink in the sub tank.	<ul style="list-style-type: none"> Perform sub tank maintenance. If an error related to the sub tank occurs Also check the remaining amount of ink in the ink bottle. If the message is displayed even after executing this step, contact your local distributor, or our sales office or call center.



Message	Cause	Solution
<LOCAL> SUB TANK: CMYKYMCCICIWW	Liquid level sensor abnormality of the sub tank has been detected.	<ul style="list-style-type: none"> Turn off the power on the machine and turn it on after a while. If displaying again, contact your local distributor, our sales office, or service center.
<LOCAL> Overflow: :CMYKYMCCICIWW	Ink overflow from the sub tank has been detected.	<ul style="list-style-type: none"> Perform sub tank maintenance. If an error related to the sub tank occurs If displaying again, contact your local distributor, our sales office, or service center.
<LOCAL> LevelH: :CMYKYMCCICIWW	Though certain amount was consumed, there is no change in the sub tank sensor error indicating high level.	
<LOCAL> LevelL: :CMYKYMCCICIWW	Though certain amount was consumed, there is no change in the sub tank sensor error indicating low level.	
<LOCAL> MACHINE TEMP./H ***°C	Machine temperature is high.	<ul style="list-style-type: none"> Adjust the ambient temperature of the place where the machine is used.
<LOCAL> MACHINE TEMP./L ***°C	Machine temperature is low.	
<LOCAL> Replace SupplyPUMP	The supply pump in the ink path must be replaced soon.	<ul style="list-style-type: none"> The supply pump needs to be replaced. Contact your local distributor, our sales office, or service center.
<LOCAL> Replace SuctionPUMP	The suction pump in the ink path must be replaced soon.	<ul style="list-style-type: none"> The suction pump needs to be replaced. Contact your local distributor, our sales office, or service center.
<LOCAL> Replace Ymotor Brush	Time to replace the brush of Y motor.	<ul style="list-style-type: none"> The brush of Y motor needs to be replaced. Contact your local distributor, our sales office, or service center.

Ink error

Ink error is also displayed in the local guidance.

 ["Displaying other information"\(P. 112\)](#)

Message	Cause	Solution
NON INK IC : ---- YYKK	Ink IC chip of the ink bottle cannot be read properly.	<ul style="list-style-type: none"> Reinsert the ink bottle for which the warning occurred. If displaying again, contact your local distributor, our sales office, or service center.
WRONG INK IC : ---- YYKK		
INK TYPE : ---- YYKK	The ink of the ink bottle is of a different type than the ink currently supplied.	<ul style="list-style-type: none"> Check the ink type of the ink bottle for which the warning occurred.

Message	Cause	Solution
INK COLOR : ---- YYKK	The color of ink in the ink bottle is of a different type than the currently supplied ink.	<ul style="list-style-type: none"> Check the color of the ink bottle for which the warning occurred.
WRONG INK BOTTLE : ---- YYKK	An error occurred in the Ink IC chip information of the ink bottle.	<ul style="list-style-type: none"> Replace the ink bottle for which the warning occurred.
NO INK BOTTLE : ---- YYKK	Ink bottle is not set in the external ink supply unit.	<ul style="list-style-type: none"> Set the ink bottle on the bottle holder for which the warning occurred.
EXPIRATION : ---- YYKK	The ink has expired.	<ul style="list-style-type: none"> Replace with new ink or use up as quickly as possible. Printing is possible.  "Replacing an Ink Bottle"(P. 42)
Expiration:1MONTH : ---- YYKK	The ink is one month past its expiration date and cannot be used.	<ul style="list-style-type: none"> Replace with new ink or use up as quickly as possible. Printing is possible.  "Replacing an Ink Bottle"(P. 42)
Expiration:2MONTH : ---- YYKK	The ink is two months past its expiration date and cannot be used.	<ul style="list-style-type: none"> Replace with new ink. Printing will be unavailable soon.  "Replacing an Ink Bottle"(P. 42)

Error message





When an error message is displayed, eliminate the error according to the following table.

Message	Cause	Solution
CAN'T OPERATE : INK ERROR	An ink error occurred.	<ul style="list-style-type: none"> Check the ink bottle of the supply path corresponding to the indicated color.
CAN'T OPERATE : DATA REMAIN	Data is being received.	<ul style="list-style-type: none"> Clear the data.  "Deleting the Received Data (Data Clear)"(P. 69)
ERROR 04 PARAM ROM	There is an abnormality in the parameters.	<ul style="list-style-type: none"> Turn off the power on the machine and turn it on after a while. If displaying again, contact your local distributor, our sales office, or service center.
ERROR 108 HD CONNECT [1 2 3 4 5 6 7 8 9 10 11 12]	Head connection cannot be confirmed.	
ERROR 108 HD THERMIS [1 2 3 4 5 6 7 8 9 10 11 12]	Head temperature cannot be read.	
ERROR 12a HDC SPEED	Abnormality occurred in the ink discharge waveform.	
ERROR 12e Head Failed [x x x x]	Abnormality of the head and waveform driver occurred.	
ERROR 122 CHECK : SDRAM	There is no PRAM.	

Message	Cause	Solution
ERROR 128 HDC FIFO OVER	<ul style="list-style-type: none"> Data transmission speed is too fast. Control circuit board is defective. 	
ERROR 128 HDC FIFO UNDER	<ul style="list-style-type: none"> Data transmission speed is too slow. Control circuit board is defective. 	
ERROR 129 BATTERY EXCHANGE	Dead battery of internal clock has been detected.	<ul style="list-style-type: none"> Contact your local distributor, our sales office, or service center.
ERROR 130 HD DATA SEQ	Head data transfer error occurred.	<ul style="list-style-type: none"> Turn off the power on the machine and turn it on after a while. If displaying again, contact your local distributor, our sales office, or service center.
ERROR 148 E-LOG SEQ	Sequential number abnormality of the event log occurred.	
ERROR 151 Main PCB V1R2	Error occurred in the 1.2 V power supply to the main PCB.	
ERROR 152 Main PCB V2R5	Error occurred in the 2.5V power supply to the main PCB.	
ERROR 153 Main PCB V3R3	Error occurred in the 3.3V power supply to the main PCB.	
ERROR 154 Main PCB V05	Error occurred in the 5V power supply to the main PCB.	
ERROR 155 Main PCB V35-1	Error occurred in the main PCB 35-1 V power supply.	
ERROR 156 Main PCB V5B	Error occurred in the main PCB 5 VB power supply.	
ERROR 157 Main PCB VTT	Error occurred in the main PCB VTT power supply.	
ERROR 158 Main PCB V352	Error occurred in the main PCB 35-2 V power supply.	
ERROR 15f HEAD DRIVE HOT	COM driver is hot.	
ERROR 16e Main PCB V3R3B	Error occurred in the main PCB 3.3 VB power supply.	
ERROR 171 NEW HEAD CONNECT	New head connection was recognized.	
ERROR 172 Main PCB Q6 Check	The main PCB Q6 has malfunctioned (short mode).	

Message	Cause	Solution	
ERROR 186 HDC OVERFLOW	Error detected in the print waveform.		
ERROR 186 HDC UNDERFLOW			
ERROR 187 HDC SLEW RATE			
ERROR 188 HDC MEMORY			
ERROR 18a Main PCB V_CORE	Error occurred in the main PCB power supply.		
ERROR 18b Main PCB V1R5B	Error occurred in the 1.5 V power supply to the main PCB.		
ERROR 18c Main PCB V12	Error occurred in the 12V power supply to the main PCB.		
ERROR 18e FLS NOT COMP [1 2 _ _]	An error occurred in the flushing control.		
ERROR 18f OFFSET START [1 2 _ _]	An error occurred in the head voltage control.		
ERROR 18f OFFSET END [1 2 _ _]			
ERROR 19d HDC V36 [1 2 _ _]	An error occurred in the HDC circuit board voltage.		
ERROR 19f LED CONNCT ERR: *****	The LED UV is not connected.		
ERROR 201 COMMAND	The machine received some data other than the command data.		<ul style="list-style-type: none"> Securely connect the interface cable. Use an interface cable conforming to the specifications.
ERROR 202 PARAMETER	Parameter outside the range of acceptable numeric values was received.		
ERROR 203 Ment Command	A maintenance command error occurred.		
ERROR 304 USB INTI ERR	USB device initialization failure.	<ul style="list-style-type: none"> Turn off the power on the machine and turn it on after a while. If displaying again, contact your local distributor, our sales office, or service center. 	
ERROR 305 USB TIME OUT	Timeout error occurred in the USB device.		
ERROR 401 MOTOR X	Excessive load was applied to the X motor.		
ERROR 402 MOTOR Y	Excessive load was applied to the Y motor.		

Message	Cause	Solution
ERROR 403 X CURRENT	An error due to excessive current of X motor was detected.	
ERROR 404 Y CURRENT	An error due to excessive current of Y motor was detected.	
ERROR 444 Replace Ymotor Brush	Time to replace the brush of Y motor.	<ul style="list-style-type: none"> The brush of Y motor needs to be replaced. Contact your local distributor, our sales office, or service center.
ERROR 505 MEDIA JAM	Media has jammed.	<ul style="list-style-type: none"> Take out the media and reset it.
ERROR 509 HDC POSCNT	HDC position counter error occurred.	<ul style="list-style-type: none"> Turn off the power on the machine and turn it on after a while. If displaying again, contact your local distributor, our sales office, or service center.
ERROR 50a Y ORIGIN	Y origin could not be detected.	
ERROR 50f L-SCALE BLACK	Abnormality occurred in linear scale.	
ERROR 510 X ORIGIN	X origin could not be detected.	
ERROR 519 NEGATIVE P.SENSOR	The value of negative pressure sensor is abnormal.	<ul style="list-style-type: none"> Adjust the pressure.  "If pressure abnormality occurs"(P. 170) If displaying again, contact your local distributor, our sales office, or service center.
ERROR 51a POSITIVE P.SENSOR	The value of positive pressure sensor is abnormal.	
ERROR 617 SUB TANK: 1 2 3 4 5 6 7 8 9 10 11 12	Liquid level sensor abnormality of the sub tank has been detected.	<ul style="list-style-type: none"> Turn off the power on the machine and turn it on after a while. If displaying again, contact your local distributor, our sales office, or service center.
ERROR 618 LevelH: 1 2 3 4 5 6 7 8 9 10 11 12	Though certain amount was consumed, there is no change in the sub tank sensor error indicating high level.	<ul style="list-style-type: none"> Perform sub tank maintenance. If an error related to the sub tank occurs If displaying again, contact your local distributor, our sales office, or service center.
ERROR 619 LevelL: 1 2 3 4 5 6 7 8 9 10 11 12	Though certain amount was consumed, there is no change in the sub tank sensor error indicating low level.	
ERROR 61a Overflow: 1 2 3 4 5 6 7 8 9 10 11 12	Ink overflow from the sub tank has been detected.	
ERROR 61b SUPPLY: 1 2 3 4 5 6 7 8 9 10 11 12	Ink could not be supplied to the sub tank.	<ul style="list-style-type: none"> Adjust the pressure. Also check the remaining amount of ink in the ink bottle. If an error related to the sub tank occurs

Message	Cause	Solution
		If displaying again, contact your local distributor, our sales office, or service center.
ERROR 61c NEGATIVE P.CONTROL	Abnormality in the starting of negative pressure control.	<ul style="list-style-type: none"> Adjust the pressure.  "If pressure abnormality occurs"(P. 170) If displaying again, contact your local distributor, our sales office, or service center.
ERROR 61d NEGATIVE P.NotEnough	Negative pressure cannot be maintained.	
ERROR 61e NEGATIVE P.OVER		
ERROR 61f POSITIVE P.CONTROL	Abnormality in the starting of positive pressure control.	
ERROR 620 POSITIVE P.NotEnough	Positive pressure cannot be maintained.	
ERROR 621 PPOSITIVE P.OVER		
ERROR 637 INK LEAK 1 --	Ink leak detected in ink supply route.	<ul style="list-style-type: none"> Turn off the power on the machine and turn it on after a while. If displaying again, contact your local distributor, our sales office, or service center.
ERROR 64C NCU error	The function cannot be executed due to an error.	<ul style="list-style-type: none"> Turn off the power on the machine and turn it on after a while.  "Turning off the power"(P. 53)
ERROR 650 NCU CONNECT	A problem was detected with the NCU connection.	
ERROR 651 REPLACE NCU	A problem was detected with the nozzle clogging assessment.	<ul style="list-style-type: none"> The NCU must be replaced. Contact your local distributor, our sales office, or service center.
ERROR 652 NCU detection error (HW)	A problem was detected with the nozzle clogging assessment.	<ul style="list-style-type: none"> Clean the NCU.  "Cleaning the NCU"(P. 126)
ERROR 653 NCU NZK CHK (MARK)		
ERROR 654 NCU CENTER POS	Printing position adjustment failed.	
ERROR 655 NCU FLUSH POS		
ERROR 656 NCU SN Adjst error	Sensor sensitivity adjustment failed.	
ERROR 657 Replace NCU Ink Pad	The NCU ink absorber is full.	The NCU ink absorber must be replaced. Contact your local distributor, our sales office, or service center.
ERROR 658 NCU Sensor Lv Low	The sensor's sensitivity is impaired.	Clean the NCU.  "Cleaning the NCU"(P. 126)

Message	Cause	Solution
ERROR 65b NCU Sens Adj Err H	Sensor sensitivity adjustment failed.	Replace the NCU if the error does not clear. Contact your local distributor, our sales office, or service center.
ERROR 65c NCU Sens Adj Err L		
ERROR 702 THERMISTOR	The thermistor is defective.	<ul style="list-style-type: none"> Turn off the power on the machine and turn it on after a while. If displaying again, contact your local distributor, our sales office, or service center.
ERROR 706 DRV OVHT 0**0**	UVLED Driver circuit board is hot.	
ERROR 707 IHD HEATER BREAK	Head heater is disconnected.	
ERROR 711 LED OVHT 0**0**	UVLED circuit board is hot.	
ERROR 714 INK HEATER COM ERR	Communication error of ink heater circuit board	
ERROR 715 InkHeaterRThr: 12	Ink heater thermistor is defective.	
ERROR 715 InkHeaterFThr: 12		
ERROR 716 InkHeaterRTmp: 12	Abnormality in ink heater temperature.	<ul style="list-style-type: none"> Turn off the power on the machine and turn it on after a while. When power is ON, the screen for selecting whether to control the ink heater is displayed. [>] Press the (START) key and start the ink heater control. If displaying again, contact your local distributor, our sales office, or service center.
ERROR 716 InkHeaterFTmp: 12		
ERROR 717 InkHeaterRBrk: 12	Ink heater was disconnected.	<ul style="list-style-type: none"> Turn off the power on the machine and turn it on after a while. If displaying again, contact your local distributor, our sales office, or service center.
ERROR 717 InkHeaterFBrk: 12		
ERROR 718 InkHeaterPCB Thr: 12	Thermistor of the InkHeaterPCB is defective.	
ERROR 719 InkHeaterPCB Fuse: 12	InkHeaterPCB Fuse has blown .	
ERROR 71a UV-DRV Fuse: *****	Fuse of the UVLED Driver circuit board has blown.	
ERROR 902 DATA REMAIN	There is remaining received data that has not been printed yet.	<ul style="list-style-type: none"> Clear the data.  "Deleting the Received Data (Data Clear)"(P. 69)
ERROR 90d NO HEAD SELECT	The number of installed heads is 0.	<ul style="list-style-type: none"> Turn off the power on the machine and turn it on after a while.

Message	Cause	Solution
		If displaying again, contact your local distributor, our sales office, or service center.
ERROR 920 MACHINE TEMP./L ** ° C	Ambient temperature is outside the allowable range (low).	<ul style="list-style-type: none"> Adjust the ambient temperature of the place where the machine is installed.
ERROR 924 MACHINE TEMP./H ** ° C	Ambient temperature is outside the allowable range (high).	

SYSTEM HALT

Message	Solution
SYSTEM HALT (*). 000: MESSAGE	<ul style="list-style-type: none"> Turn off the power on the machine and turn it on after a while. Check the error number, and contact your local distributor, or our sales office or call center. ("000" is the error number.)

Chapter 6 Appendix



This chapter

contains the lists of the specifications and functions of this machine.

Specifications	184	Order of Ink Bottles	187
Machine specifications	184	Inquiry Sheet	188
Ink specifications	185	LICENSE Library	189

6.1 Specifications

Machine specifications

Item		Specifications
Print head	Method	Drop-on-demand piezoelectric print heads
	Specifications	3 heads: 2 heads staggered on color 2 in line, special color 1 in line
Printing conditions (scan × feed)	4-color + white + clear 4-color + white + clear + primer 4-color + white ^{*2}	300 × 300HQ: Bi/Uni 4/8 pass 300 × 450HQ: Bi/Uni 6/12 pass 600 × 600: Bi/Uni 8/16 pass 600 × 900: Bi/Uni 12/24 pass 1200 × 1200: Bi/Uni 16/32 pass
	6-color + white + clear	300 × 300HQ: Bi/Uni 8/16 pass 300 × 450HQ: Bi/Uni 12/24 pass 600 × 600: Bi/Uni 16/32 pass 600 × 900: Bi/Uni 24/48 pass 1200 × 1200: Bi/Uni 32/64 pass
Usable inks		Dedicated UV curable ink (Y, M, C, K, Lm, Lc, W, CL, Pr)
Ink supply		1 L × 8 bottles
Ink capacity	4-color + white + clear	C/M/Y/K: 1 bottle each; W/CL: 2 bottles each
	4-color + white + clear + primer	C/M/Y/K/CL/Pr: 1 bottle each, W: 2 bottles each
	4-color + white ^{*2}	C/M/Y/K: 1 bottle each; W: 4 bottles each
	6-color + white + clear	C/M/Y/K/Lc/Lm: 1 bottle each; W: 2 bottles
Usable media	Size	2500 mm x 1300 mm
	Thickness	50mm or less
	Weight	Up to 50 kg/m ² ; there should be no concentration of load
Maximum print range		2500 mm x 1300 mm
Distance accuracy	Absolute accuracy	±0.3 mm or ±0.3% of the designated distance, whichever is larger
	Reproducibility	±0.2mm or ±0.1% of the designated distance, whichever is larger
Perpendicularity		±0.5 mm/500 mm
Head height adjustment		1.2 mm to 3 mm (automatic recognition of media thickness)
Media adsorption		Fixed adsorption using the vacuum unit
UV unit	UV LED lamp fitting (mounted on carriage)	
	UV power source installed in the main body	
Waste ink tank		Detected by bottle type (2600 cc)/Software counter
Interface		USB2.0/Ethernet/1000BASE-T

Item		Specifications
Command		MRL-III
Noise	During standby	55 dB or less
	When operating ^{*1}	75 dB or less
Applicable standards		VCCI-classA, FCC ClassA, ETL conforming to UL62368-1, CE Marking (EMC Directive, Low Voltage Directive, Machinery Directive), IEC/EN62368-1 (CB Certification), RoHS compatible, Reach compatible, EAC, RCM
Power supply specifications		200-240 AC \pm 10%, 50/60 Hz \pm 1 Hz, 12 A or less
Power consumption		2880 W or less
Installation environment	Allowable temperature	15°C to 30°C (59°F to 86°F)
	Relative humidity	35 to 65% Rh (No condensation)
	Accuracy guaranteed temperature	18°C to 25°C (64.4°F to 77°F)
	Temperature gradient	\pm 10°C/h or less
	Dust	0.15 mg/m ³ (equivalent to normal office level)
Weight		Approximately 600kg
External dimensions		4400 mm (W) \times 2450 mm (D) \times 1250 mm (H) (including protrusions)

*1. 73.5 db (A), Operation conditions: High-speed scanning, blower is ON: According to clause 1.7.4.2 of Machinery Directive 2006/42/EC.

*2. When using this ink set, OPT-J499 is required.

Ink specifications

Item		Specifications
Form		1 L Ink bottle
Color		Black ink Cyan ink Magenta ink Yellow ink White ink Light cyan (LUS-150, LH-100 ink only) Light magenta (LUS-150, LH-100 ink only) ClearInk (LH-100 ink, LUS-120 ink, LUS-350 ink, LUS-211 ink) Primer ink (PR-200)
Ink capacity		1 liter
Shelf life		The expiration date is printed on the ink bottle. Should be used within three months after opening regardless of the expiration date.
Storage temperature	Storage	5 to 30°C (storage at 30°C is permitted for a period of 1 month or less)
	Transportation	1 to 60°C (storage permitted only for 120 hours or less if the temperature is 60°C and one month or less if the temperature is 40°C)

Important!

- Do not use any ink other than the MIMAKI designated ink.
Also, do not disassemble the ink bottles or refill or replenish their ink.
 - Ink could freeze if left in a cold place for a long period of time.
If the ink freezes, thaw it at room temperature (25°C) for at least three hours before using.
However, if you use thawed ink, the print quality deteriorates due to the deterioration of ink.
Store ink in an environment where it will not freeze.
-

6.2 Order of Ink Bottles

The order of the set ink bottles differs depending on the ink set used.

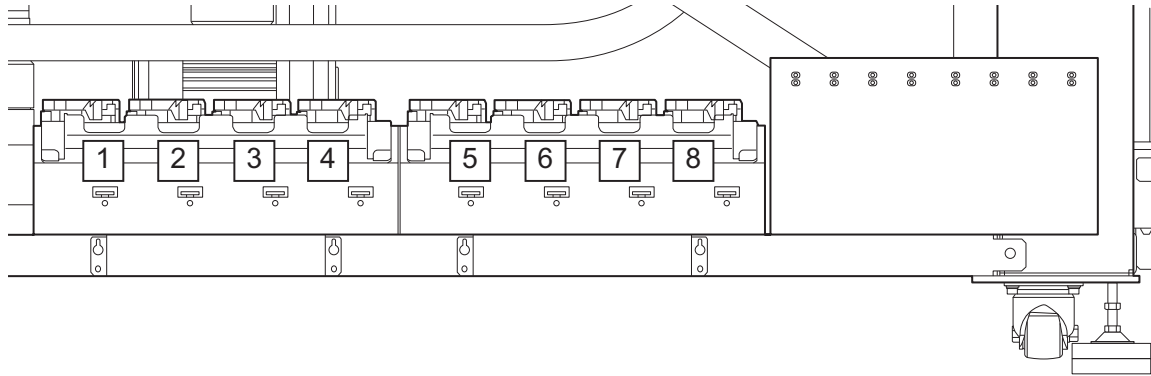

Ink set	Ink distribution							
	1	2	3	4	5	6	7	8
4-color + white ink + clear	C	M	W	W	Y	K	Cl	Cl
4-color + white ink + primer + clear	C	M	W	W	Y	K	Pr	Cl
4-color + white ink(OPT-J499 required)	C	M	W	W	Y	K	W	W
6-color + white ink + clear	C	M	Cl	W	Y	K	Lm	Lc

6.3 Inquiry Sheet

Use this sheet for inquiries regarding printer malfunctions and abnormal operations.

Fill in the following required fields and fax the sheet to our sales office.

Company Name	
Contact Personnel Name	
Contact No.	
Printer Model Name	
Your OS	
Machine Information ^{*1}	
Error message	
Inquiry Details	

*1. Take a look at  "Confirming Machine Information"(P. 110) and fill in the necessary information.

6.4 LICENSE Library

Mimaki printer Firmware

Copyright ©2020 MIMAKI ENGINEERING CO.,LTD. All rights reserved.

This product contain open source software listed in the tables below.

Component	License
StarterWare for ARM® based TI Sitara Processors	BSD-TI

The following license terms and conditions shall apply to the open source software listed in the table above:

BSD-TI

Copyright (C) 2010 Texas Instruments Incorporated - <http://www.ti.com/>

Redistribution and use in source and binary forms, with or without modification, are permitted provided that the following conditions are met:

1. Redistributions of source code must retain the above copyright notice, this list of conditions and the following disclaimer.
2. Redistributions in binary form must reproduce the above copyright notice, this list of conditions and the following disclaimer in the documentation and/or other materials provided with the distribution.
3. Neither the name of Texas Instruments Incorporated nor the names of its contributors may be used to endorse or promote products derived from this software without specific prior written permission.

THIS SOFTWARE IS PROVIDED BY THE COPYRIGHT HOLDERS AND CONTRIBUTORS "AS IS" AND ANY EXPRESS OR IMPLIED WARRANTIES, INCLUDING, BUT NOT LIMITED TO, THE IMPLIED WARRANTIES OF MERCHANTABILITY AND FITNESS FOR A PARTICULAR PURPOSE ARE DISCLAIMED. IN NO EVENT SHALL THE COPYRIGHT OWNER OR CONTRIBUTORS BE LIABLE FOR ANY DIRECT, INDIRECT, INCIDENTAL, SPECIAL, EXEMPLARY, OR CONSEQUENTIAL DAMAGES (INCLUDING, BUT NOT LIMITED TO, PROCUREMENT OF SUBSTITUTE GOODS OR SERVICES; LOSS OF USE, DATA, OR PROFITS; OR BUSINESS INTERRUPTION) HOWEVER CAUSED AND ON ANY THEORY OF LIABILITY, WHETHER IN CONTRACT, STRICT LIABILITY, OR TORT (INCLUDING NEGLIGENCE OR OTHERWISE) ARISING IN ANY WAY OUT OF THE USE OF THIS SOFTWARE, EVEN IF ADVISED OF THE POSSIBILITY OF SUCH DAMAGE.

JFX200-2513EX Operation Manual

January, 2024

MIMAKI ENGINEERING CO.,LTD.

2182-3 Shigeno-otsu, Tomi-shi, Nagano 389-0512 JAPAN

D203431-23-10012024

