

Operation Manual

COLOR INKJET PRINTER

ML Tiger-1800B MK III

OPERATION MANUAL

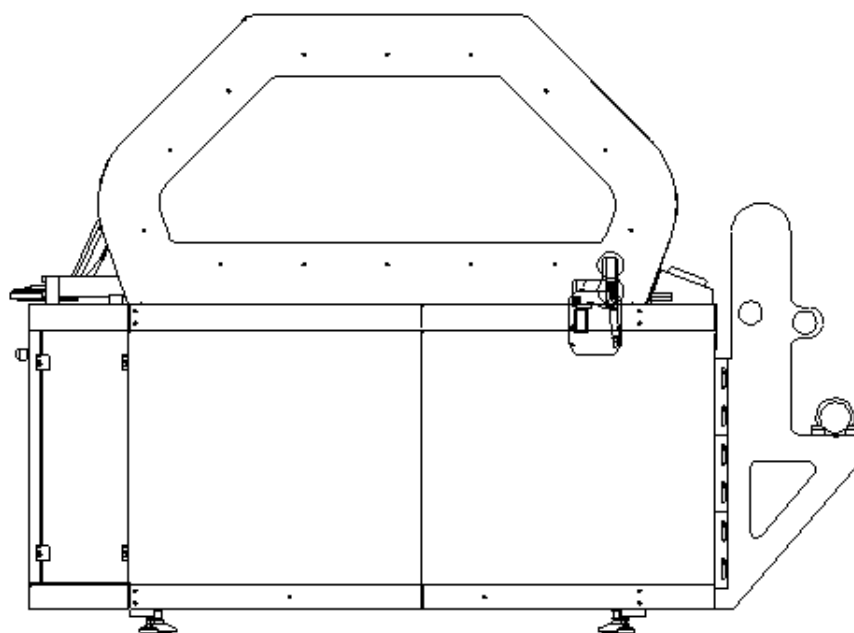

MIMAKI ENGINEERING CO., LTD.

<https://mimaki.com/>

D203491-11

Original instructions



- This manual explains the operation and maintenance of “ML Tiger-1800B MK III” (hereafter referred to as this machine). Read carefully and fully understand it before using this machine.
- The machine has to be used only for the purpose agreed in the contract and has to be operated under conditions compatible with those specified in the manual.
- Any use of the machine other than that specified in the contract requires our written consent.
- The use which does not obtain consent from our company is considered to be an unintended use. In this case, we assume no responsibility for property damage or personal injury, and regard the warranty of this machine as invalid.
- Misuse of this machine can cause it to stop working for a long time. If this happens, our engineer must deal with it in order to restart the operation.



- Images in this manual was inserted for the purpose of describing the function of the machine and may not refer to your version. For instance, they may be different from your machine due to a specific request from the final customer.

TABLE OF CONTENTS

Chapter 1 Introduction

Positioning of Operation Manual	1-2
Purpose of Operation Manual	1-2
Documents Supplied with This Machine	1-2
Manufacturer's Authorization	1-2
Normative Standard	1-2
Handling of This Manual	1-3
Safety Precaution	1-5
Electrical Equipment	1-7
General Safety Instructions	1-7
Warning Label	1-9
Warning Label Display Position	1-12

Chapter 2 Outline Explanation

Outline Explanation	2-2
Description of Machine Units	2-2
Feeding Unit	2-2
Main Parts of Machine	2-5
Overall Dimensions	2-10
Identification of This Machine	2-11

Chapter 3 Usage Precautions

The Intended Use	3-2
Unauthorized Use	3-2
Emergency Stop by Operator	3-2
The Service Life of This Machine	3-2

Chapter 4 Installation

Outline	4-2
Aptitude of Workers	4-2
Preparing the Installation Site	4-2
Installation Requirement	4-3
Loading, Placement, Installation procedure	4-3
Lifting Procedure	4-4
Unpacking and Placement	4-5
Connection	4-7
Storage Condition	4-8

Chapter 5 Push Button Panel

Work Station	5-2
Push button panel (P01)	5-3
Push Button Panel (P02)	5-4
Emergency switch (PEM)	5-4

Chapter 6 Basic usage

Introduction	6-2
Description of screen configuration	6-2
Explanation of operation method	6-5
Explanation of screen when executing process	6-7
Print operation	6-8
Description of the print content	6-8

Flow to printing	6-9
Operation during printing	6-18
SYSTEM ALARM	6-21
Indication when an error is occurred	6-21
Operation restrictions when an alarm occurs	6-23
How to clear the alarm	6-24
Cleaning	6-25
Cleaning at any time	6-25
Auto maintenance setting	6-27
Nozzle recovery	6-30
MAINTENANCE	6-38
Description of maintenance content	6-38
Operation of Control panel	6-39
SETTING	6-40
Description of the setting content	6-40
Example of setting procedure - Color bar	6-41
Feature description	6-42
STATUS bar	6-42
MENU	6-44
Quick function	6-65

Chapter 7 Operation, Adjustment, and Maintenance

Training to Workers (Operators)	7-2
Operators	7-2
Operator Work	7-2
Preparation Before Starting Work	7-2
Transport of media	7-3
Printer	7-4
Pause	7-4
Long-term Suspension	7-4
Procedure for Cleaning and Adhesive Application	7-5
Preparation of Belt Cleaning Unit	7-5
Adjust the Squeegee Blade	7-6
Replacing Squeegee Blade	7-7
Belt Cleaning Procedure	7-10
Cleaning	7-10
Change Wiper Blade	7-11
Replacing Ink Tank	7-13
Refill the Cleaning Solution (Wiper Cleaning Solution)	7-16
Installation / Replacement of Waste Tank	7-18

Chapter 8 Safety Devices and Residual Risks

Safety Devices	8-2
Residual Risks	8-3
Mandatory Requirements and Safety Precautions	8-3

Chapter 9 Maintenance

Maintenance Overview	9-2
Ordinary Maintenance	9-2
Scheduled Maintenance	9-2
Summary Table for Maintenance Work	9-4
Special Maintenance	9-4

Troubleshooting	9-5
Dismantling	9-27

Chapter 1

Introduction



This chapter

describes the Operation Manual, safety precautions, and the like.

Positioning of Operation Manual	1-2
Purpose of Operation Manual	1-2
Documents Supplied with This Machine ...	1-2
Manufacturer's Authorization	1-2
Normative Standard	1-2
Handling of This Manual	1-3
Safety Precaution	1-5
Electrical Equipment	1-7
General Safety Instructions	1-7
Warning Label	1-9
Warning Label Display Position	1-12

Positioning of Operation Manual

This operation manual (this manual) is produced according to the manual production procedure and is regarded as a part of the product's components. This manual has been revised as necessary, and the revision history is managed appropriately.

All copying and publishing rights concerning this manual and accompanying related documents are protected by Mimaki's copyright.

Purpose of Operation Manual

This operation manual provides information so that workers (operators) can work with this machine to do their work safely.

Documents Supplied with This Machine

Operation manual: Contains a complete set of information for proper use of this machine.

Electrical drawings: Explain the main system of this machine. It is intended for engineers who solve problems.

Maintenance parts list: It is not included.

Manufacturer's Authorization

Mimaki has been approved as a machine maker according to the legislation through the following certificates.

- Operation manual (this manual)
- CE Declaration of Conformity

Normative Standard

Revisions of this machine and manuscripts of this manual are prepared according to the following standards and directives.

Standards

EN 60204-1:2006 Safety of machinery - Electrical equipment of machines – Part 1: General Requirements

ISO12100-1:2010 Safety of machinery - General principles for design

DIRECTIVES

MACHINERY DIRECTIVE 2006/42/EC, of European Parliament and Council of 17th May 2006

ELECTROMAGNETIC COMPATIBILITY (EMC) 2014/30/ECon the approximation of the laws of Member States relating to electromagnetic compatibility

RoHS Directive

Handling of This Manual

This manual is considered part of the product and must be stored and used for the entire lifetime of the machine. When you lend or transfer this machine, hand the manual with the machine.

Keep this manual in a location that is easily accessible.



This manual contains information on operator training.













Read the information described in this manual before proceeding with installing, using, adjusting, and maintaining this machine.

- Keep this manual properly (protected dry place).
- If this manual is damaged, purchase a new manual at our company. (See P.1-4).
- This manual reflects the latest information on the point of sale of the product.
- Our company reserves the right to modify the manuals without any obligation to update preceding products or manuals, except in special cases (e.g. for safety issues).
- Customers can obtain additional information by contacting us.
- Any proposal from the user to improve the manual or the machine will be welcomed and carefully evaluated.
- When selling this machine, the user is required to report the address of the new owner to us so that additional information to this manual can be conveyed smoothly to the new owner.



The manual is structured in operating procedures described as a series of steps.

These steps are shown in the table below:

Procedure		Sample procedure			
S	Mode	Key	Indication	Operation	Reference
1				Manual operation	
2		P01-No.3	Emergency reset	Luminous pushbutton: press it to reset the machine work, returning the machine to the initial phase.	5-3
3	AUT			Automatic operation	
4				Confirm whether it is executed correctly.	
End of procedure					

Meaning		
	Danger	Failure to observe the instructions given with this symbol can result in death or serious injuries to personnel. Be sure to read it carefully and use the printer properly.
	Warning	Failure to observe the instructions given with this symbol can result in death or serious injuries to personnel. Be sure to read it carefully and use the printer properly.
	Caution	Failure to observe the instructions given with this symbol can result in minor or medium injuries to personnel.
	General Warning	This symbol indicates that the items shown need to be noted. Specific notes are drawn in the figure  .
	General Mandatory Action	This symbol indicates that the action shown must be executed. Specific instruction is drawn in the figure  .
	General Prohibition	This symbol indicates that the action shown is prohibited. Specific action that is prohibited is drawn in the figure  .
	Important	Important notes for the use of this printer are given with this symbol. Understand the notes thoroughly to operate the printer properly.
	Hint	Useful information is given with this symbol. Understand the notes thoroughly to operate the printer properly.
	Reference	This symbol indicates the reference page for related contents. Click the text to display the corresponding page.

Below is a description of each item.

Table	Column data
S (Step)	It identifies the step.
Mode	<p>There are the following modes.</p> <p>Manual </p> <p>Require to press a pushbutton or a function key </p> <p>Use visual control operation or measuring equipment </p> <p>Operations automatically executed by this machine (AUT.)</p>
Key	Indicates the key (or the icon on the operator panel) for performing a specific operation. The relevant keyboard and reference number (such as P01 No.3) are also indicated.
Indication	Descriptions on the panel or descriptions of function keys. In automatic mode it indicates the operating block enabled.
Operation	This is an explanation of the operation performed by the operator or the operation that is executed periodically automatically.
Reference	It represents a reference page or figure.

Below are definitions of terms used in this manual.

Table	Definition
Dangerous zone	The inside and peripheral area of this machine. If there is a person inside, its safety and health hazards arise.
Operator	A worker who operates, adjusts, periodically maintains or cleans this machine.
Maintenance worker	Mimaki's approved technician who can install, repair, and regular or special maintenance work.
Mimaki's technician	Mimaki's maintenance worker performing complicated operations and specific operations

Order- and information-related request

For copies of this manual or information on manual related, service related, technical support, spare parts, please contact your local distributor, our sales office, or service center.



MIMAKI ENGINEERING CO.,LTD.
2182-3 Shigeno-otsu, Tomi-shi, Nagano 389-0512 JAPAN

Limitations of warranty

Unless there is a specific agreement on the contract, Mimaki shall use it for the normal operation of this machine (only if it is used in accordance with the instructions stated in this manual and maintenance manual), to manufacture this machine we guarantee the compliance of the machine against the quality of the material and the technical features described in this document.

Mimaki's warranty is not a replacement or addition of the parts warranty used by Mimaki during the manufacture of this machine. Therefore, the parts maker's warranty will be effective for these parts.

The warranty is no longer valid in the following conditions:

- Use of materials not indicated in the technical specifications, in particular, non-observance of the maximum weight and diameter of media rolls.
- Do not perform scheduled lubrication work.
- Do not follow instructions.
- Do not follow maintenance rules.
- Repair of workers not approved by Mimaki.
- Inappropriate repair (use spare parts other than original).

Note: It is strictly forbidden to the customer and / or third parties (except authorized employees of Mimaki) to make changes of any kind and size on the machine and its functions, and to this manual.

Safety Precaution

Special attention is required for the following work.



- When apply the adhesive on the belt, turn ON the key.



- When operate the belt at low speed, turn OFF the belt heater.
- Places where there is a possibility of contact with the Primary power supply should not be opened in the power ON state (electrical unit of main unit, carriage rear cover, and electric unit in heater electric unit).

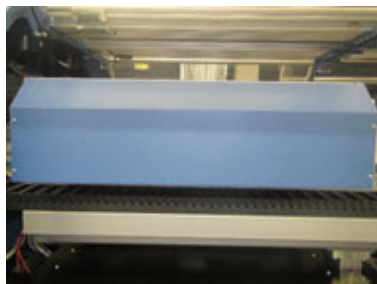

- When working on at the lower surface of the carriage in the maintenance space, make sure to open the door after the carriage reaches the maintenance space.

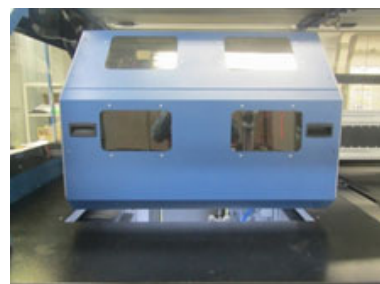
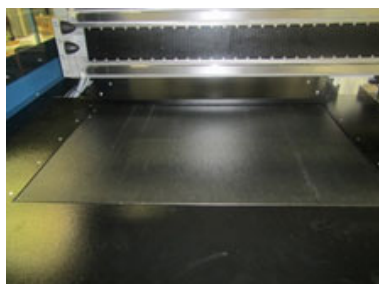



- Be careful not to get your hands caught in the cleaning unit.

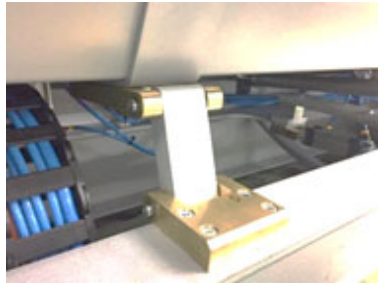
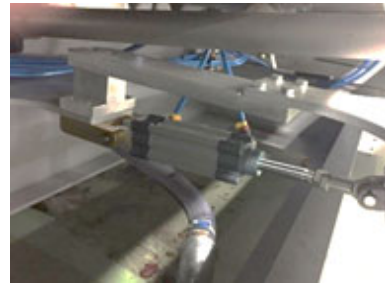

- Be careful not to pinch your hands on the tension bar.



- Be careful not to pinch your hands on the pressure roller.

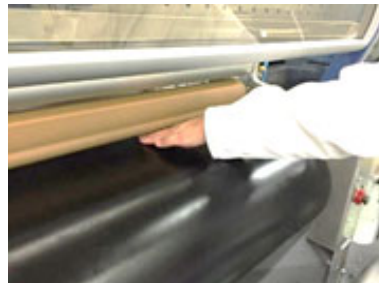

- Be careful not to get your hands caught in the cover.





- Be careful not to pinch your hands etc. on the top cover of the heater.



- Be careful not to catch your hands at the belt edge cover.



Electrical Equipment

This equipment has been designed and manufactured to carry out specifications and functions agreed with customers. It is not allowed to use the machine for other uses, as there may be a danger to human life or a failure of this machine or your product.

Electrical supply

The electrical supply unit will function correctly when it satisfies the conditions of the following electricity supply items.

Voltage	AC380 V $\pm 10\%$
Frequency	50 Hz $\pm 1\%$ or 60 Hz $\pm 1\%$
No. of phases	3-Phase 5-Wire (L1,L2,L3,N,PE)

Repair

In case of trouble or malfunction of this machine, required to notify our company. We will give instructions to our engineers and provide information needed to solve the trouble for the customers.



- Operation of this machine should be performed by a maintenance worker or a trained operator.
- During operation, dangerous voltage is applied to this machine.
- Failure to follow warnings could result in injury to operators.
- Only maintenance workers and operators can perform work on this machine and the periphery of this machine.
- The operator must understand all the dangerous situations and maintenance procedures described in this manual.

General Safety Instructions

The operation of this machine has been carefully and thoroughly analyzed during the preparation of this manual.

Therefore, the indicated number of operators, their qualifications, and the intervention procedures are optimized to ensure safety and health of them and achievement of their final objective.

If the work contents and work procedures are changed and the number of operators is increased or decreased, there is a possibility that the safety of the operators themselves may be exposed to serious danger or the desired results may not be obtained.



- The owner is responsible for the disclosure of this manual to all operators who operate this machine.

Safety indications

Safety is secured under normal operating conditions. However, in order to further improve the level of safety at work, it is recommended that operators should adopt an attitude of security alert.

In particular, please take the following preventive measures.



- Carefully read the operation procedure described in this manual before the start-up operation, maintenance or any other operations of this machine.
- Strictly follow this information and all safety and warning information stated on the safety sign attached directly to the machine.
- The operator must fulfill all the usage requirements of the machine.
- Protective devices for the operator's safety must be installed and made operational.
- In particular, before starting up the machine for each work shift, make sure that the protective guard is correctly positioned, the safety device is operating properly, and the on-board equipment is correctly installed and operating.
- Be sure to use the individual protective devices required by safety regulations during work.
- Do not wear bracelets, rings, necklaces, etc. as there is a possibility of serious injury. Before starting work, remove any potential danger.
- Before starting the installation, check whether there is any dangerous situation at the installation site and check that there are no foreign matters inside the machine or on this machine.
- Execute the startup sequence of this machine exactly as recommended.
- Do not approach the operation area of this machine during operation.
- Do not place your hand near or in the moving parts or charging parts of this machine or in the electrical box.
- Do not work in a dark place. Use all available lighting and work properly (over 300 lux).
- Refrain from using this machine in the state of ingesting medicines and drinks that may lead to the slowing of movement and thinking.
- Before doing anything, work on all preventive measures and take them.
- Do not leave the machine unattended when in use.
- Make sure that the entire work area is clearly visible.
- Always keep the work area clean.
- If there is any abnormality in the operation of the on-board equipment, notify our maintenance person.
- Avoid loose clothing and wear protective clothing.

Safety during maintenance

- Maintenance operation must be carried out by qualified personnel.
- Before performing any maintenance or lubrication work, stop the machine using the procedures described in this manual.
- When removing and installing components using lift, check the load capacity of the lift.
- Quickly transfer the load to the support and the stand after lifting.
- Do not try to climb up or descend from the machine while it is up and running.
- Never use gasoline, solvents or flammable liquids to clean the parts. Use a commercial nonflammable non-toxic detergent.
- If repair or maintenance at places not reachable from the ground or floor is necessary, follow the regulations of each country and region, use a ladder or an elevating step platform.
- Perform all maintenance and repair carefully as described in this manual.
- Be sure to use personal protective equipment.
- Use a power tool that complies with the current safety standards.
- Before starting the machine, make sure that no one is carrying out maintenance operations.
- Do not work under or near the operating area of this machine if support and fixation are insufficient.
- Wear safety glasses with side shields.
- Operate this machine according to intended use conditions.
- The use of this machine must comply with the current safety standards of the country or region to be used.
- The owner of the machine is responsible for maintaining it in a state where the safety is securely ensured.
- The owner of this machine must review this machine at intervals suitable for the operating conditions.
- Avoid loose clothing and wear protective clothing.

Warning Label





Warning label

Part No.	Label name	Fig.
	Caution label-movable part	
M903330	Caution label-works	
M912054	Caution label-pinching	
M907935	Label-Danger voltage	
M910931	Caution label-front cover falling	
M901581	Caution label	
M909381	Caution label-Y bar	
M903764	Caution label- UV power voltage	
M914168	Caution label-applying glue	

M914167	Caution label-belt	
M903404	Caution label-movable part	
M903239	Caution label-Temperature	

Prohibition label

Part No.	Label name	Fig.
	Prohibition label-prohibition on removal of safety guard	
M903406	Ground label	
M913888	Label-C.10 mark	
M916752	Tiger1800B Mk3 rated label	
M915604	Caution label- two outlet	
M915603	Power connection label	

M915602	Feeding relay connector rated label	
M915605	X12ETH-3 Mark label	
M915601	PC outlet rated label	
M915598	DRYERJET rated label	
M915608	Main switch label	

Warning Label Display Position

- Do not remove the warning label on the machine.
- Make sure that the label is clearly legible and not covered with parts.
- If the label deteriorates, contact us and change it.

(1) Electrical box

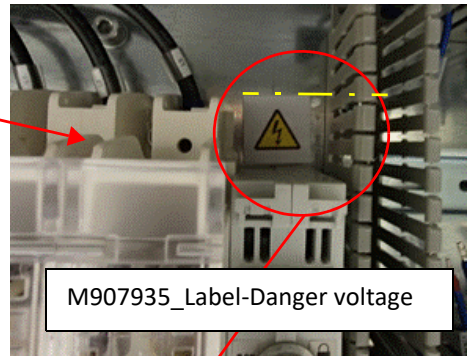
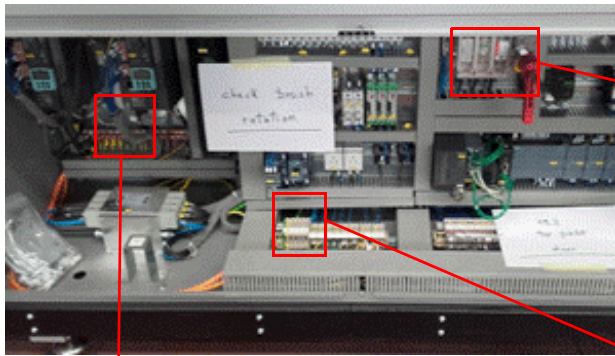

M907935_Label-Danger voltage

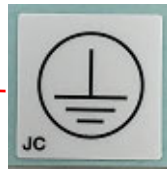
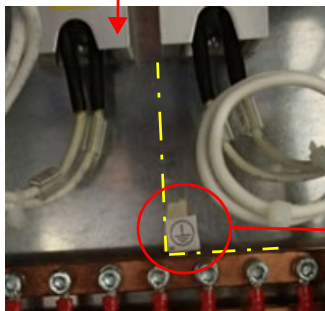

M903406-00_Ground label

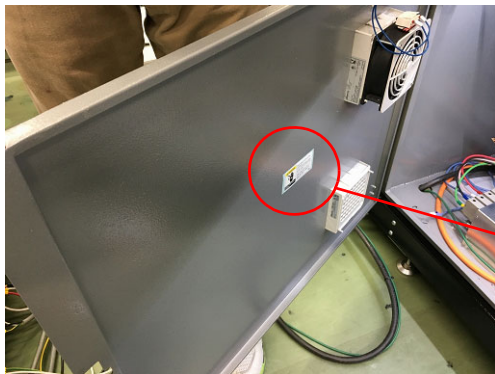
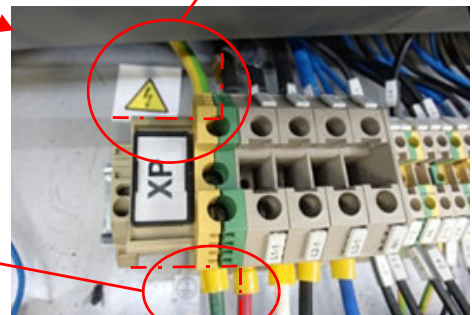

M903764_Caution label- UV power voltage



(2) Belt
Front

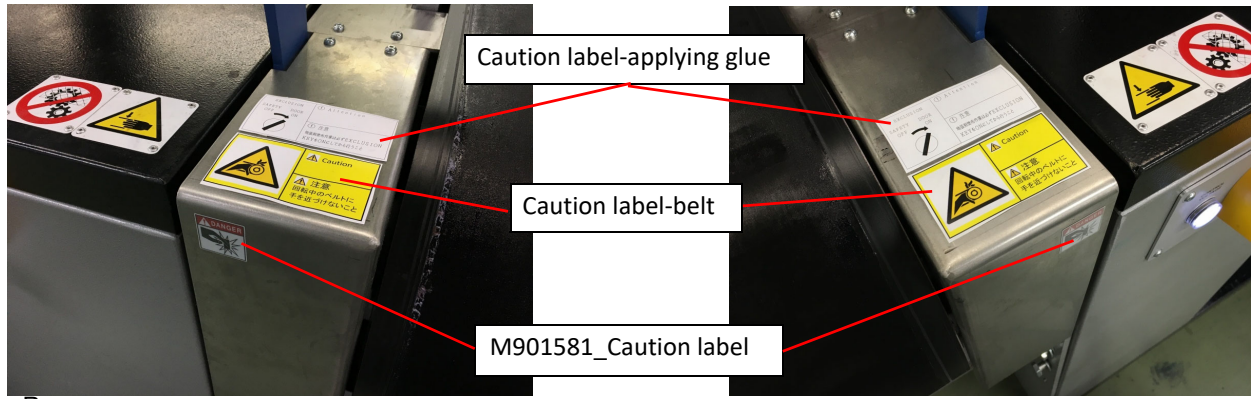

Rear



(3) Carriage

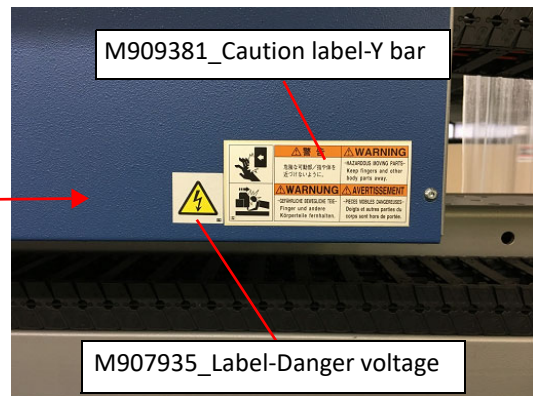
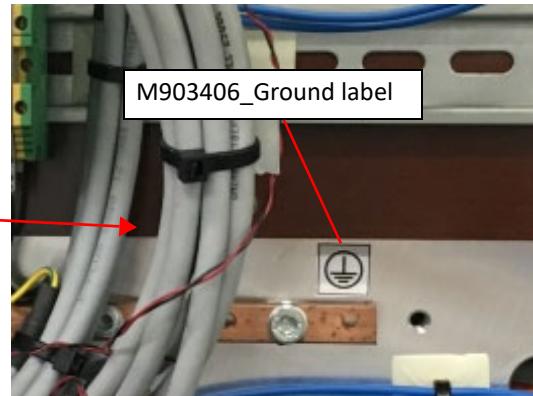
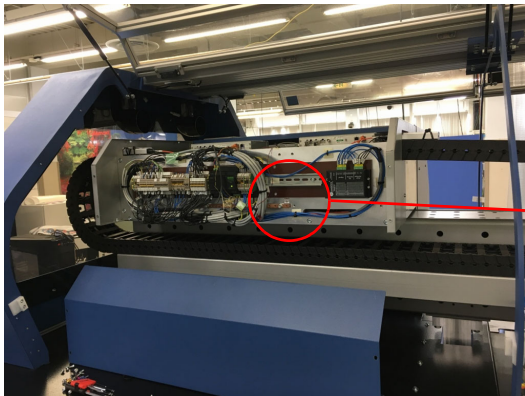

(4) Left front cover



(5) Left rear cover



(6) Right rear cover



(7) Right side cover



(8) Station



(9) Model label



(10) Plastic cover
Front

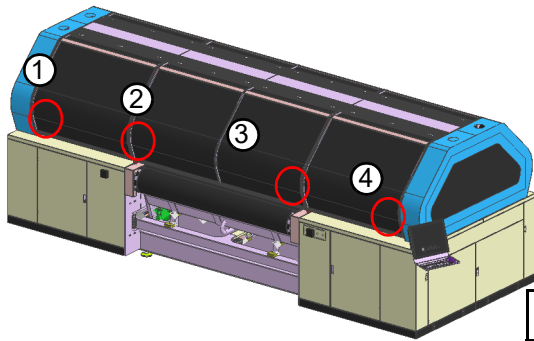

M910931_Caution label-front cover falling: 4 pieces

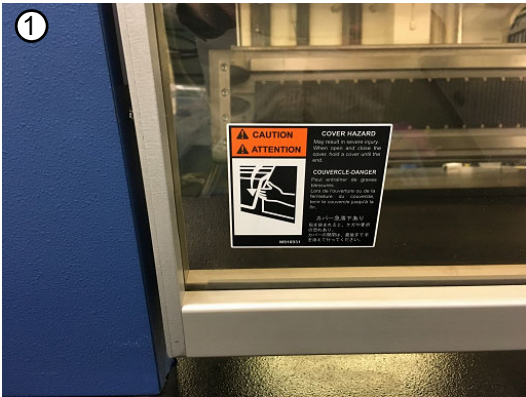

Rear

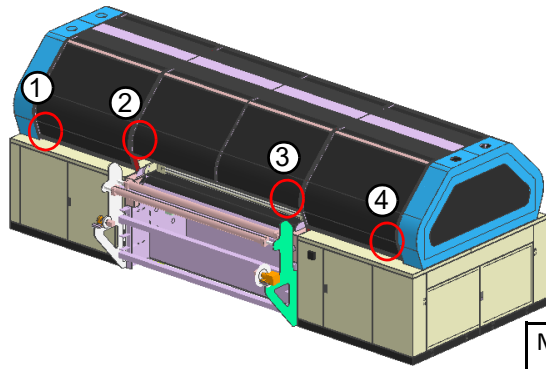

M910931_Caution label-front cover falling: 4 pieces

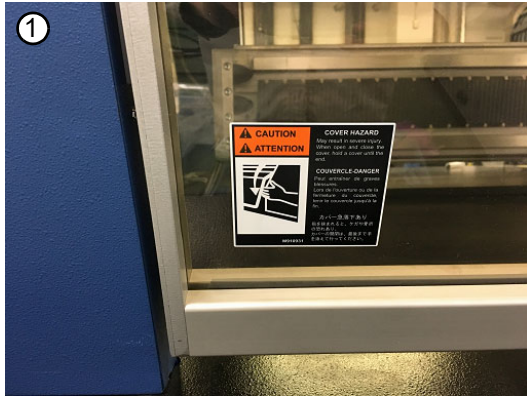

1

(11) Display label
Electrical Box side

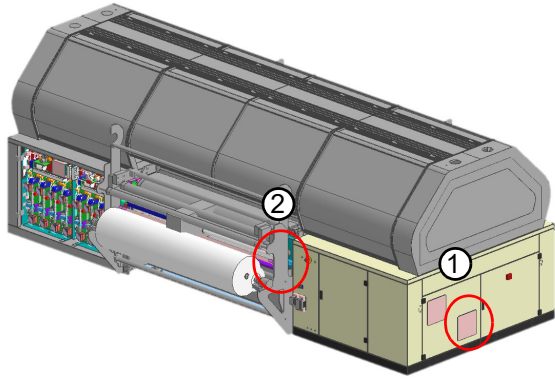

M916752 Tiger1800B Mk3 rated label

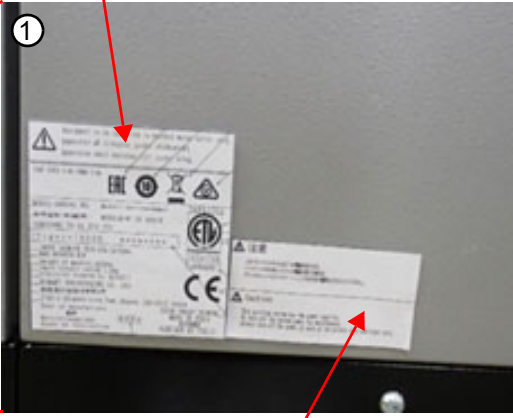
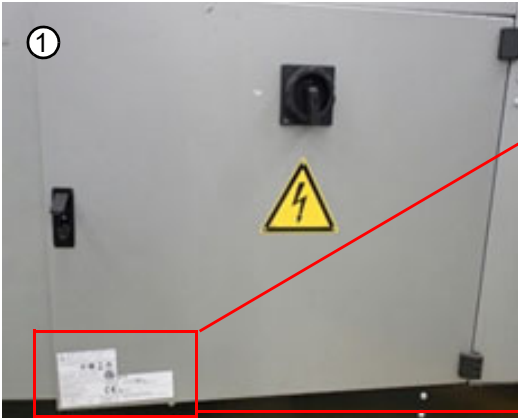

M915604 Caution label - two outlet



M915605 X12ETH-3_Mark label

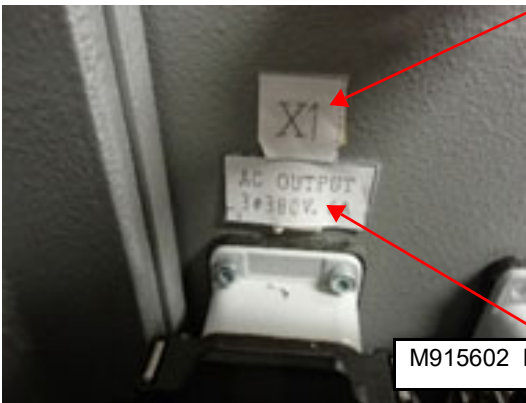

M915602 Feeding Relay connector rated label

M915603 Power connection label

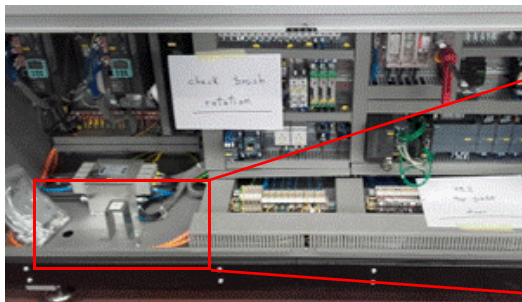

M915601 PC outlet rated label

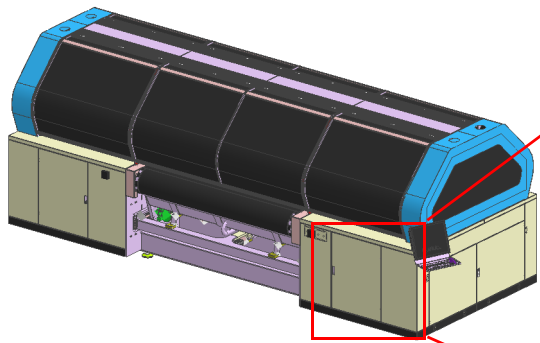

Chapter 2

Outline Explanation



This chapter

provides an outline of the main unit for this machine and describes its features.

Outline Explanation	2-2
Description of Machine Units	2-2
Feeding Unit	2-2
Main Parts of Machine	2-5
Overall Dimensions	2-10
Identification of This Machine	2-11

Outline Explanation

ML Tiger-1800B MK III is an inkjet printer for textile.

This machine is used for printing images and patterns on various fabrics or transfer paper (hereafter “media”).

Print quality is guaranteed by the belt carrying the media, the pressure rollers adhering the media to the belt, and the belt cleaning unit removing the excess ink adhered to the belt.

This machine functions in automatic mode, and operator's work is required in the following cases.

To operate this machine, in addition to the main unit (printer section), the feed unit and the take-up unit suitable for your application are required.

- Media set
- Media feed
- The removal of the tank when changing water, maintenance and replacement of brushes and squeegee blades
- Applying adhesive to the belt
- Unload the printed roll

The machine consists of the following units:

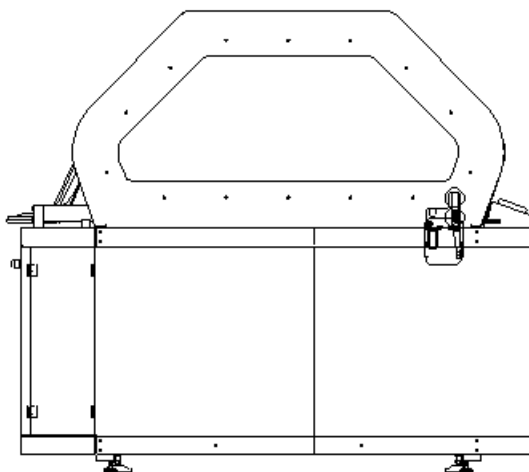

- Main unit
 - Main belt
 - Pressure roller
 - Heater
 - Belt cleaning unit
 - Ink feeding unit
- Option
 - Take-up unit
 - Feeding unit

Description of Machine Units

The main units will be explained below.

Feeding Unit

The feeding unit is arranged on the back side of the main unit. This unit is directly connected to the frame of the printer.

This unit has an air shaft for inserting the paper tube of the media roll. This air shaft has a compressed air intake port (see the figure below), tightly contact with the inside of the paper core by compressed air, and fix the media roll.

There is a pneumatic clutch on the right side of the machine so that delivery is done normally without loosening of the media. This allows the air pressure to be regulated via the regulator and to increase or decrease the braking force applied to the air shaft.

This unit has two idle rollers for feeding.

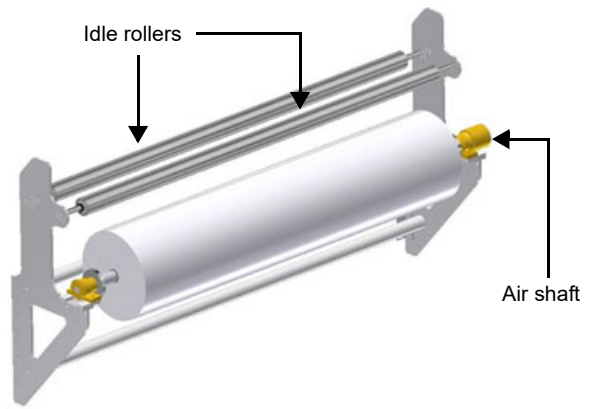
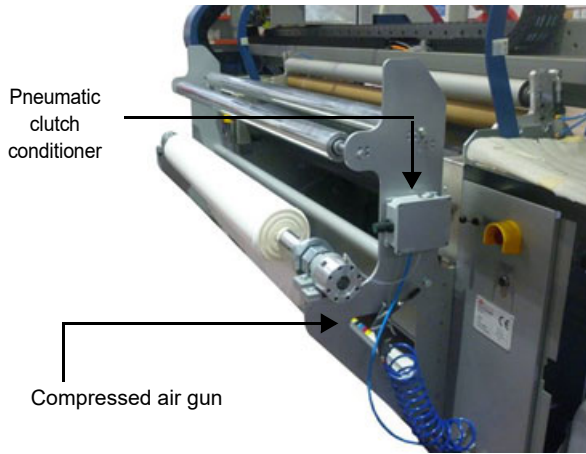

The procedure for loading and unloading a media roll is described below:

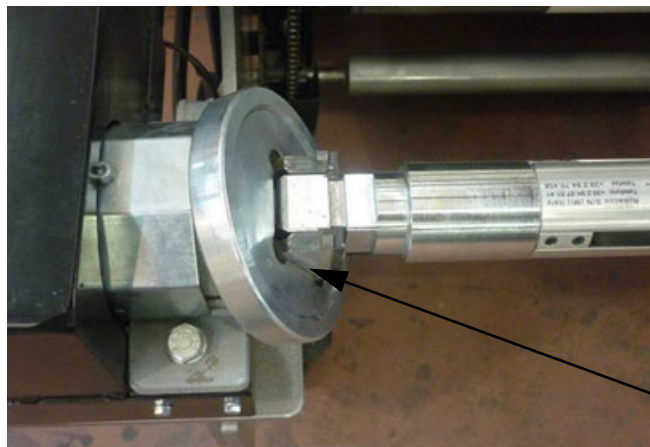

Procedure		media LOAD - UNLOAD			
S	Mode	Key	Indication	Feature	Reference
1				Remove the air shaft from the safety chuck.	Figure below
2				Insert the air shaft into the paper tube of the dough roll.	
3				Return the air shaft that set the roll to the safety chuck. If necessary, use a roll lifter.	Figure below





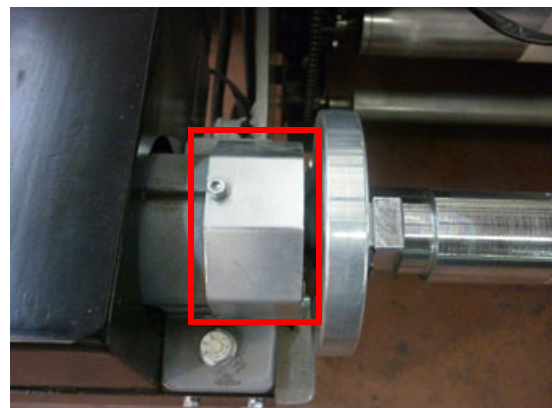
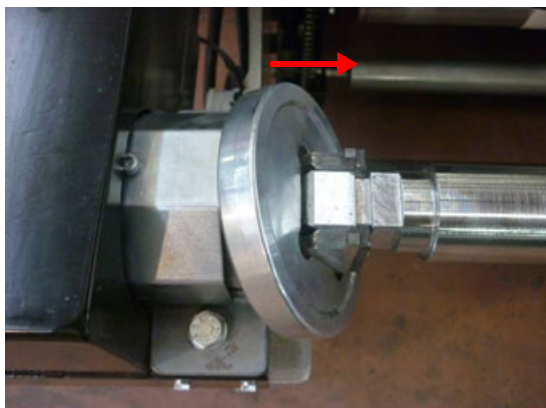

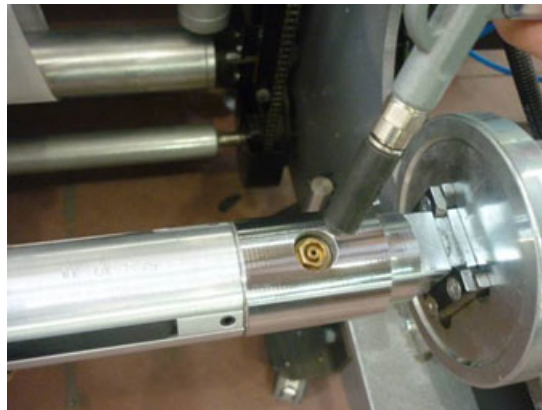

Safety chuck

4				Return the safety chuck to the original position so that the air shaft does not come off during operation.	Left figure below
5				The metallic protective part shown in the figure is returned to the rest position by the spring inside.	Right figure below





6				Feed the media roll.	7-3
7				With the compressor connected to the machine, inject compressed air into the air shaft.	Figure below

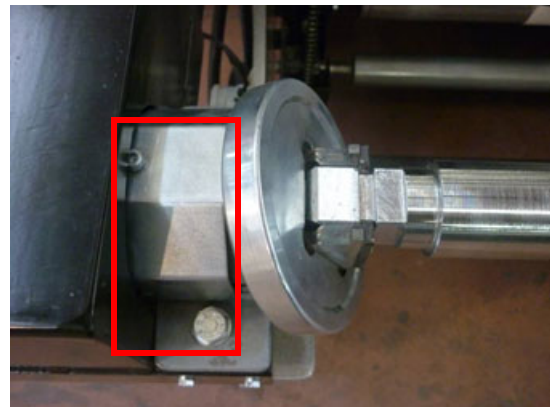
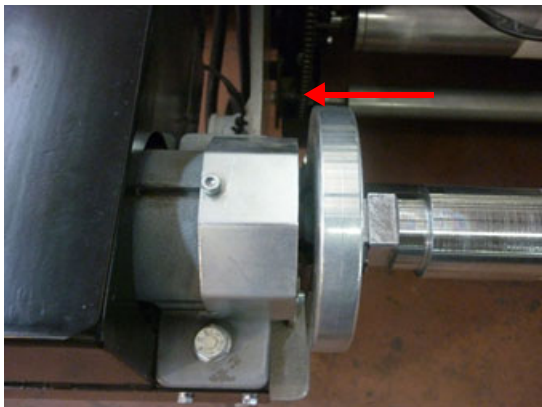

8				Turn on the pneumatic brake system and adjust the pressure with the regulator.	
9				Start the operation of this machine.	
10				When printing of the media is completed, stop the machine and push the check valve, the compressed air will come out of the air shaft.	
11				Release the pressure from the pneumatic brake and vertically placing the safety chuck in manual mode opens the shaft lock.	
12				Push the top of the shaft lock outward, the protected part, shown in the following figure moves this protection.	Figure below



13				Take out the air shaft along with the empty paper core.	
14				Take out the empty paper core and reuse it as necessary to wind up the printed paper.	
End of procedure					

Option

The following options can be used for feeding media.

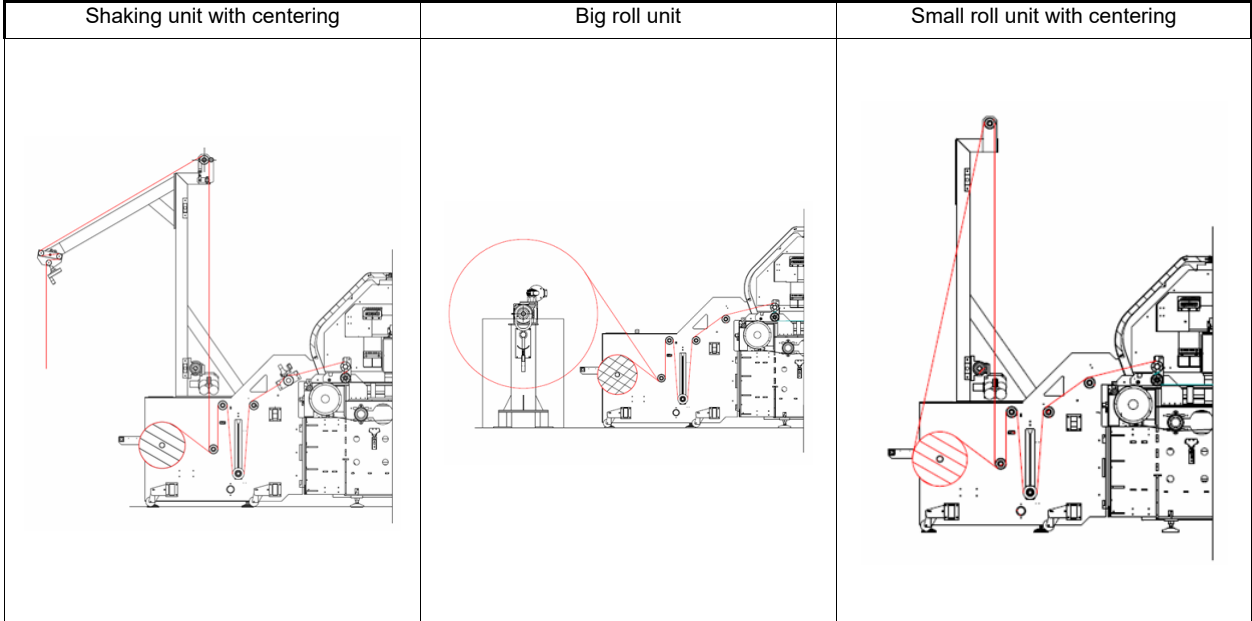

Main Parts of Machine

Main belt

The belt consists of two conveyor rollers (One is motor driven) and a rubber belt.

On the surface of the belt there is a bedding layer that makes the media that passes under the printhead completely adhere and stabilize.

The belt moves not continuously but intermittently. When the belt stops, it prints the set image by repeating printing after 1 pass or several passes printing.

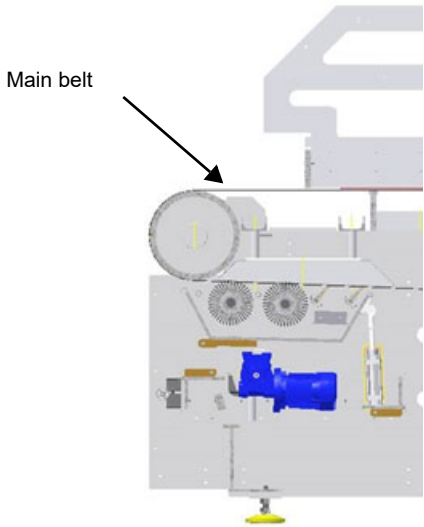

Pressure roller

The pressure roller is placed at the initial position of the belt and brings the media into close contact with the belt to prevent the occurrence of wrinkles that may affect the final printed media. Furthermore, it removes air bubbles between the belt and the media.

The pressure roller descends during printing and contacts the media and transports it. The operation of the pressure roller up and down works with a pneumatic piston.

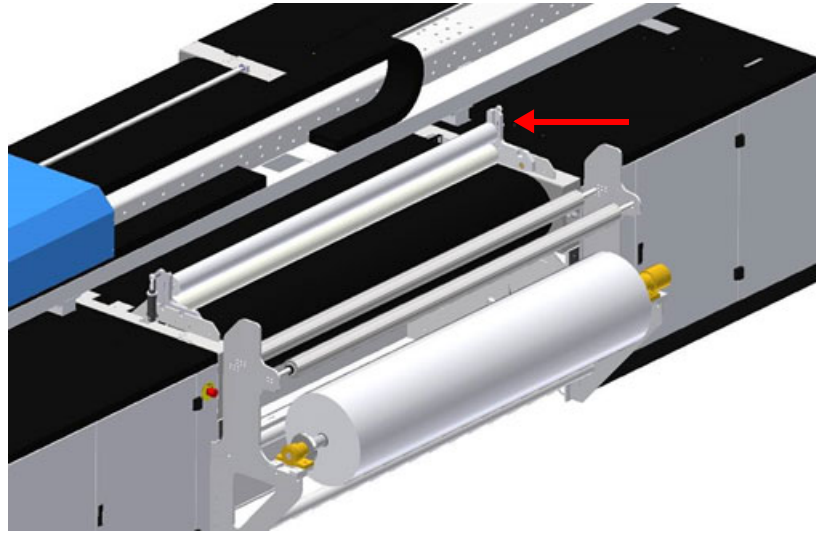

Heater

There are two infrared heaters under the belt and warm the surface of the belt to restore the adhesion of the adhesive.

Carriage

This unit carries the print head and moves it vertically in response to the movement of the belt. When the belt stops, the unit operates, moves one or more times, and prints the specified image.

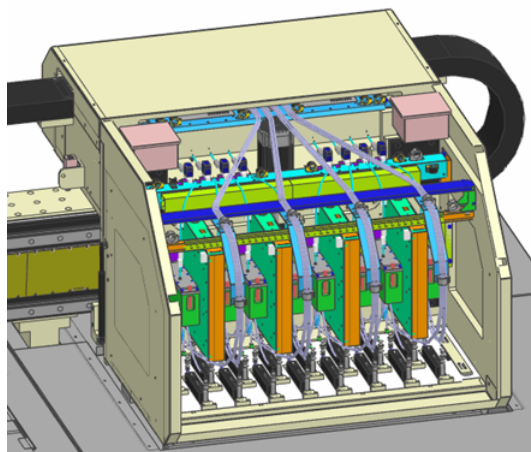

The carriage is designed to accommodate 2 print heads in each of 8 independent modules (Print head: up to 16).

Belt cleaning unit

This unit removes belt dust, residue and dirt.

The squeegee blade is made up of a metal part in the lower area and a rubber seal at the tip, removing water generated by brush operation and cleaning operation.

The water removed by the squeegee blade returns to the collection tank under the brush.

When the belt operation turns off, the tank position lowers. Three pneumatic pistons at the bottom of the tank ascend during operation and the squeegee blade and brush come into contact with the belt and perform the cleaning operation.

Washing water is discharged from the valve. When maintaining or replacing the brush and squeegee blade, you can slide out the tank and pull it out.



- Pictures in this manual are listed as a brief explanation, so it does not necessarily indicate the installed version. Actually, it may differ from the picture depending on customer's specific request.

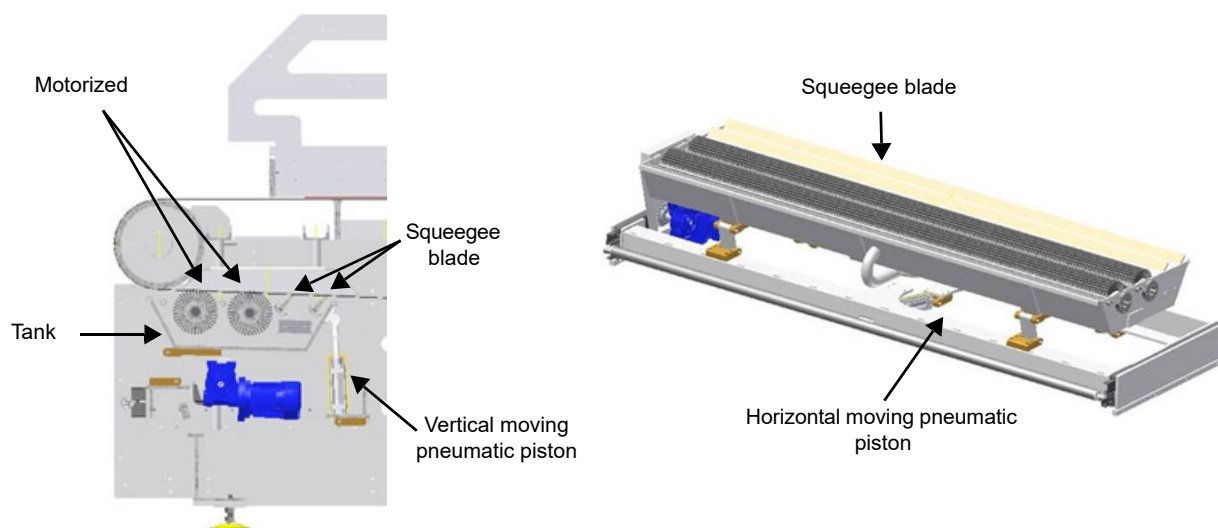

The tank moves both horizontally and vertically.

The function of a movable squeegee blade is to remove all remaining wash water, as shown below.

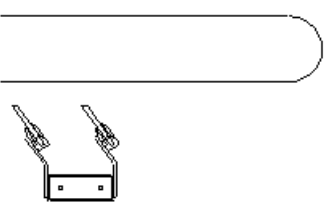
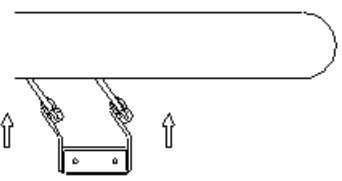
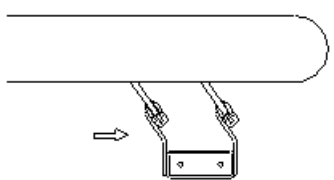
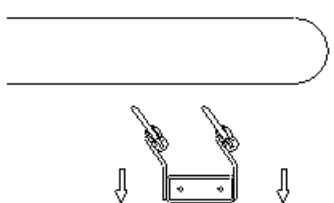
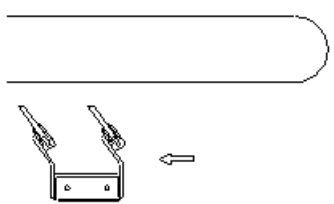
Procedure		Squeegee movement	
S	Mode	Operation	Reference
1	AUT.	<p>If the belt is not moving, the squeegee blade does not touch the belt because the washing tank is at a low position.</p> 	
2		<p>If you select to start belt feeding, the tank is lifted by the air cylinder, so the squeegee blade and the belt are in contact.</p> 	
3	AUT.	<p>After the tank rises, the squeegee blade moves horizontally in the opposite direction of the belt. After the movement, the belt feed starts.</p> 	
4		<p>After cleaning the belt, the belt stops, the pneumatic piston lowers the tank position, and the tank leaves the belt.</p> 	
5	AUT.	<p>The horizontally moving air cylinder sets the squeegee blade of the second tank to the initial position.</p> 	
End of procedure			



• The figure is an outline, and only the operation of the washing tank at the time of cleaning the belt is shown in the figure.

Ink feeding unit

Supply genuine ink to the print head attached to the carriage.

Ink is contained in eight tanks in the cabinet on the right side of this machine.

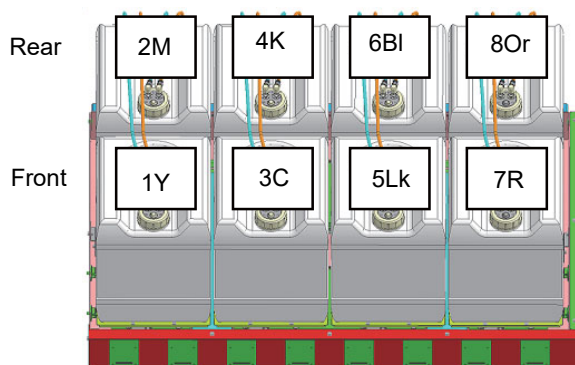
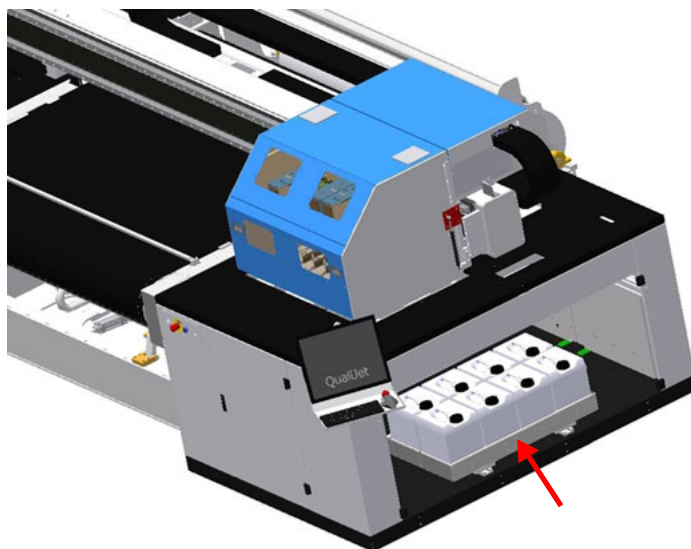

Layout of the ink tanks

Overall Dimensions

Dimensions of this machine

Below is the maximum dimension (standard model) of this machine.

Table	Feature	Data
▶	Maximum length	≈ 2800 [mm]
▶	Maximum width	≈ 5670 [mm]
▶	Maximum height	≈ 2030 [mm]

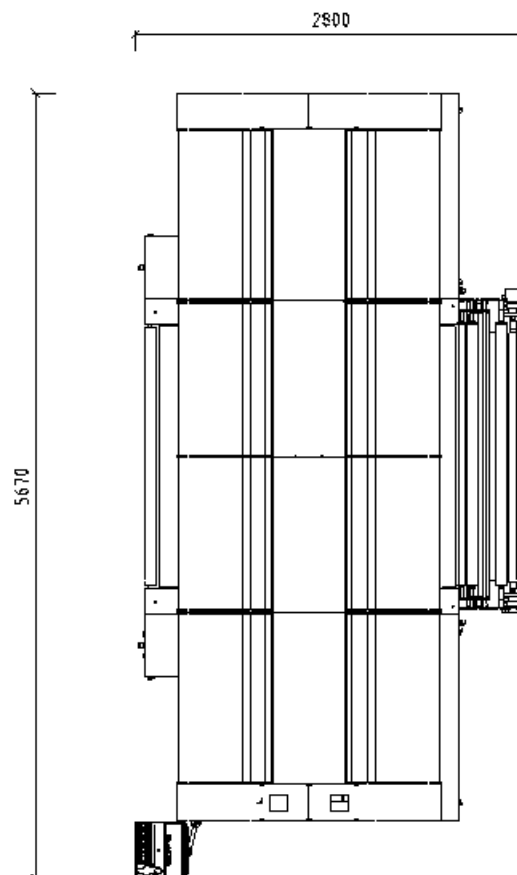
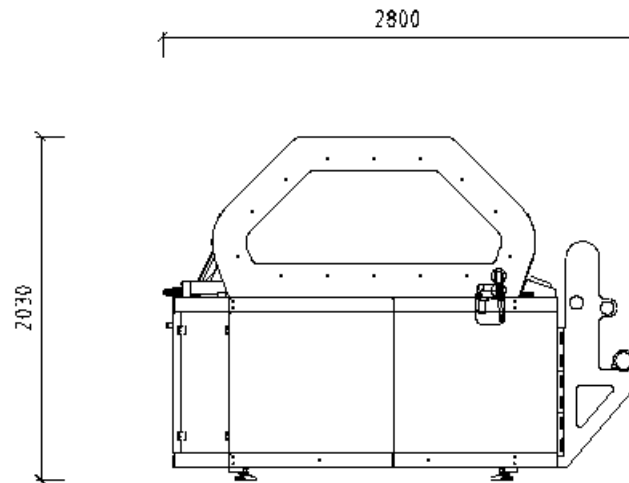

Identification of This Machine

This machine can be identified with the rated label attached.

- Manufacturer name: Mimaki
- Model: ML
- Type Tiger-1800B MKIII

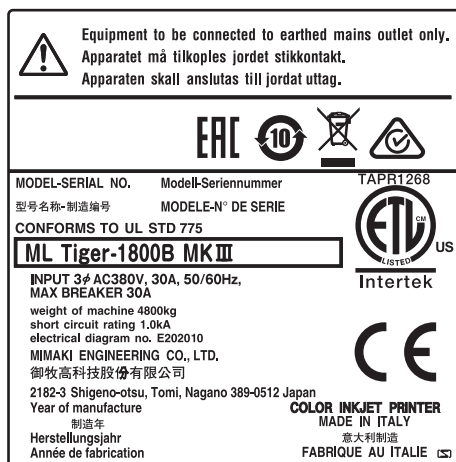

It is prohibited to remove the nameplate and replace it with another nameplate of the same type.

If the nameplate accidentally breaks or comes off from the machine, you are obliged to notify Mimaki and request a replacement label.

Chapter 3

Usage Precautions



This chapter

describes the intended use, unauthorized use, and the like of this machine.

The Intended Use	3-2
Unauthorized Use	3-2
Emergency Stop by Operator	3-2
The Service Life of This Machine	3-2

The Intended Use

ML Tiger-1800B MK III is intended for use only when observing all of the following data.

Table	Feature	Data
▶	Print width	1850 [mm]
▶	Belt width	2000 [mm]
▶	Print technology	Inkjet print head x 16
▶	media feeding	Roll axial feeding unit with brake Roll characteristics: Diameter 400 [mm], weight 100 [Kg]
▶	Ink color	8 colors (C, M, Y, K, R, Or, Bl, Lk)
▶	Ink feed	10L tank x 8
▶	Ink type	Reactive dye
▶	Power supply	380 [V] 3-phase 5 lines (L1, L2, L3, N, PE) 50/60 [Hz]

Limit the use of this machine to the operator who has read all the attached documents and understands the procedure related to handling and feeding of the media roll.

This avoids the use of this machine in abnormal or dangerous situations.

Unauthorized Use

Use this machine for agreed purpose and operate with characteristics complying with the characteristics described in the current manual.

In case of using different from contract agreement, it is necessary to obtain approval in writing by our company in advance.

In the absence of such authorization, the use is considered as unauthorized use and we do not assume any responsibility for any consequences that may affect people or objects. Thus the warranty is no longer valid.

The machine may stop due to misuse and the suspension period may be long. In that case, customers will have to call Mimaki official technical staff.

Emergency Stop by Operator



- In case of faults or operator hazards, press the emergency switch to stop the machine in order to prevent damage spreading.

In the event of mechanical failure, it is necessary to cut electric, hydraulic, and pneumatic (if any) power from the main power supply, discharge residual pressure in the circuit, and shut down the machine in order to replace damaged parts.

The Service Life of This Machine

The estimated service life of this machine is approximately 30,000 hours when using and maintaining it as described in this manual. This period is the lifetime assuming use in accordance with the contents described in the "intended use" section and may change due to modification, special application, technical update.

Chapter 4

Installation



This chapter

describes the installation of this machine.

Aptitude of Workers	4-2
Preparing the Installation Site	4-2
Installation Requirement	4-3
Loading, Placement, Installation procedure ..	4-3
Lifting Procedure	4-4
Unpacking and Placement	4-5
Connection	4-7
Storage Condition	4-8

Outline

Since this machine is divided into main units, it is easy to transport and install.

Follow the instructions in this chapter for transportation and installation work, and only specialized workers should do.



- It is necessary to identify all the places handling the machine in advance from the place secured for transportation to the installation place and to check in advance whether there is a danger zone.
- Pay attention to high pressure or high temperature electrical system, liquid or gas conduit. It is mandatory to insulate these conduits according to local laws and regulations and to prevent electrification.
- All work is done with utmost care and when lifting it is obligatory to use lifting points and appropriate equipment as specified. Confirm that there are no people present when lifting the machine or moving it. When moving, do not pass under or around this machine by anyone.

Aptitude of Workers

When using forklift trucks and cranes at the stage of handling and removal, qualified workers are obliged to work.

Preparing the Installation Site

Foundation work for installing this machine is unnecessary. Just place it on the floor of the secured place.

At the installation site, it is necessary to have a connection to the electrical system and pneumatic system.



- Before starting the installation work, make sure that the floor can support the weight of the machine sufficiently.

Secure the space shown in the figure below around this machine.

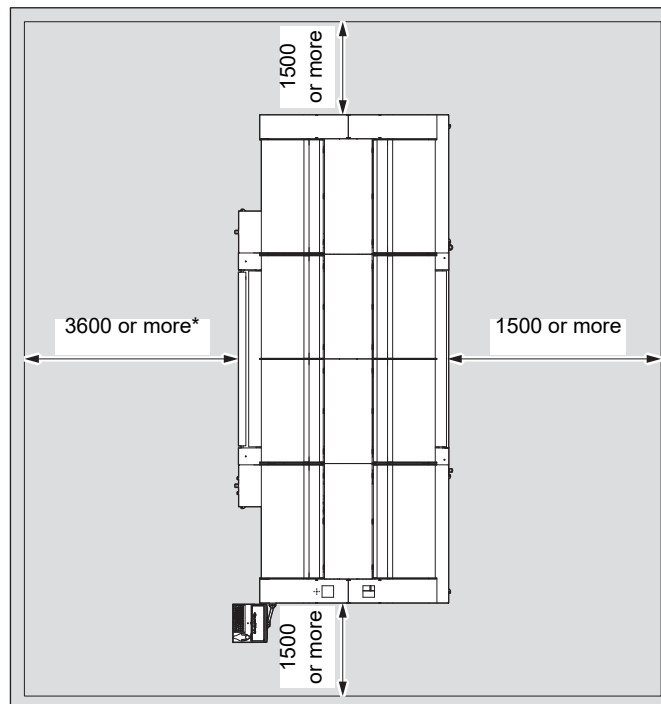

* For the direct textile printing model

For the sublimation model, 4400 or more

Installation Requirement

Place the machine on a stable horizontal surface that has sufficient strength to support its weight and absorb vibration during operation.

Use the light source (natural or artificial, or both) at the installation location to ensure a minimum illuminance of 300 [lux] for the operator's normal workstation location and control panel location.

Environmental condition

This machine is designed to be used indoors under the following conditions.

- Installation: Up to 2000 [m] (above the sea level)
- Accuracy guarantee temperature: +20 to +25 [°C]; It is guaranteed that the unit functions properly at the specified temperature. But, even small changes will affect printing.
- Allowable temperature: +15 to +30 [°C]
- Storage temperature: +5 to +35 [°C] is the proper temperatures.
- Relative humidity: Within the range of 35% to 65% (no condensation), normal operation is guaranteed.
- Electromagnetic field: Do not expose this unit, especially the cabinet, to a magnetic field that may interfere with operation.
- Mimaki assumes no responsibility for any illegal operation of this unit or operation that does not match the specification specified when using this unit under conditions other than the above.

Means for removing vibration

By properly maintaining and lubricating moving parts, special vibrations will not occur in this machine. Therefore, when vibration abnormality occurs, it is necessary to accurately check whether there are malfunction or abnormal wear of movable parts.

Loading, Placement, Installation procedure

When arranging and installing this machine, specific work (such as lowering the removed parts and placement work etc) can be done by the customer. As for other work (assembly of the machine and connection to the power supply), as stipulated in the contract already, only the workers of Mimaki have authority to execute.



- Place this machine in a place that was correctly treated by the purchaser in advance and place the floor sufficiently to support the weight of the machine.

The operation is shown below.

Procedure		Loading, placement, installation procedure			
S	Mode	Key	Description	Feature	Reference
1				Remove the protective material from this machine.	
2				Considering the size of this machine, confirm that the installation location is clean and there are no obstacles.	
3				If the installation location does not meet the requirements of the previous step, clean it to suit the location of the machine.	
4				Lift each module of the machine and place it on the floor in a predetermined place.	
5				Make sure that the projector and all its components are level at zero level.	
6				Connect various modules of this machine.	
7				Connect the electrical system and the hydraulic system.	4-7
8				Remove the packing (polyethylene, adhesive tape, etc.) if it remains.	
End of procedure					



- The machine is equipped with a motor that is filled with oil and the whole is being lubricated.
- Since this machine is delivered in a packed state, it is not necessary to clean it before the first startup.



- When installing, check whether the machine is damaged during transportation.

Lifting Procedure

We recommend using a bridge crane with appropriate characteristics when lifting the main parts of this machine. When lifting the packing containing the accessories, use a forklift.



- Make sure that lifting work does not affect this machine.

The lifting rope of this machine needs the characteristics shown in the figure and must be arranged as shown. Before lifting the machine, make sure that the balance is secured and, if necessary, adjust the rope so that the balance is perfect.



- To prevent deformation and damage of the machine, never use parts and accessories other than those instructed for lifting work.

Also, check whether the parts are damaged by contact or rubbing of the lifting rope with this machine.

The machine is equipped with wheels which allow to move it easily inside the operational unit.



- Because the photos in this book are posted as mere descriptions, they do not necessarily indicate the installed version. Actually, it may differ from the photo depending on the specific request by the final customer.

When lifting parts of this machine, please check the following figures.

To lift the assembled wire, you can loosen the screw fixing the two rollers and then lift it.

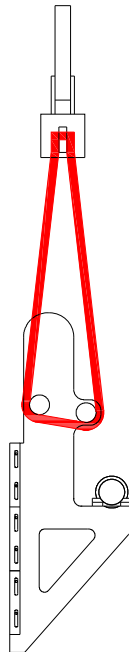

You can hoist the printer by using the appropriate lifting cable and hooking the cable to the hook shown in the figure below. The position of the hook is held by a special metal tie rod (yellow).

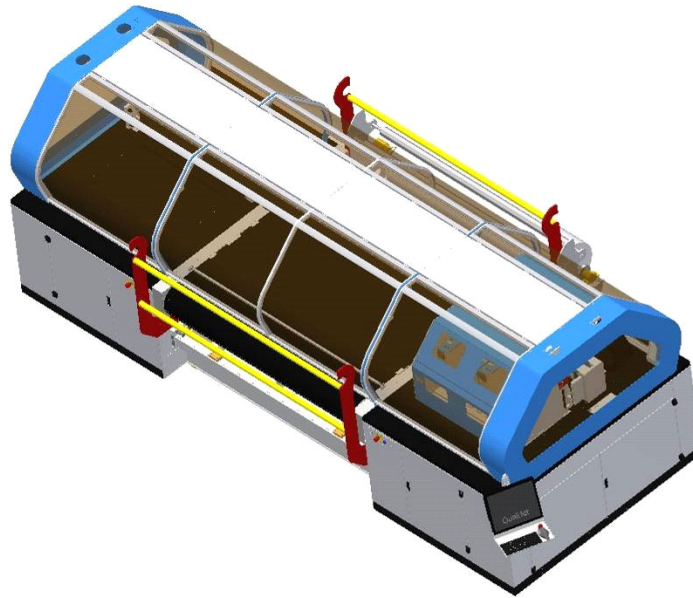

Unpacking and Placement

This machine is delivered in a fully assembled state. Follow the instructions given in this manual for transportation and installation work, only by specialized workers.



- Install this machine in a place correctly paved in advance by the purchaser. The floor of the installation place should be able to support the weight of the machine sufficiently after installing all parts.

The arrangement proceeds as follows.

Procedure		Unpacking and placement			
S	Mode	Key	Indication	Step	Reference
1				Open the box.	
2				Remove the protective stuffing wood and fixture and remove it so as not to damage the machine.	
3				Do not press the printer from a brushless motor or the like.	
4				Place the printer in the desired location.	
5				Remove the contained washing tank.	
6				Connect air system and water system for automatic cleaning.	
7				Turn on the power.	
8				Move the carpet in jog mode and confirm alignment.	
9				Move the belt in jog mode and check the operation.	
10				Place the media on the printer.	
End of procedure					

Confirmation of damage

Damage described in this section refers to damage that may occur at all stages (storage, transportation, etc.) before installation.

As soon as you receive this machine, please check whether parts are damaged or missing.

If damage occurs to this machine or accessories are lost, contact Mimaki's Assembly Director promptly.

Thoroughly examine the box and package before taking out the contents from the packaging, such as the parts of this machine. This is because multiple accessories and individual parts may be protected with the same packaging.

In particular, check whether the various parts are not physically damaged due to the impact, especially the following points.

- There is no indentation or breakage in the protective guard. If there is no indentation or damage, remove the part and check that the protected part is not damaged.
- All units of this machine are not damaged.
- There is no trace of rust on the unpainted parts.
- There are no traces of crushing or breakage in all external wiring between the electrical box and various maintenance parts (motors, limit switches, etc.).
- There are no signs of damage in the guides of various units.



- If there is damage, stop the installation work immediately, tell the responsible person of this machine the state of damage, or contact Mimaki if necessary.

Before transporting this machine to the installation site, make sure that the installation site itself is clean, that no other material or equipment is placed on the entire floor surface necessary for handling the machine, and that the transport route is clear.

Connection

The size of electrical connection, hydraulic connection, pneumatic connection (if any) should be appropriately performed in accordance with the technical data table described in this manual, taking into consideration the durability of the equipment.

To make electrical connections, follow the general installation rules for preparation and commissioning.

Specified connection should be done by a qualified and authorized personnel.



- “Qualified and authorized personnel” means an employee who has experienced special courses and training, has experience of installation, trial operation, maintenance of this machine, and recognizes rules on accident prevention. Qualified and authorized personnel must receive first aid training.



- Before connecting the power supply, shut off the main power supply of the department that installs this machine.

Electrical connection

Electrical construction is required to supply power to this unit. Ask the electric construction contractor for construction.

This machine requires a control cabinet connection to the main power supply. Also, it must be connected to the switchboard in an appropriate state.

With the main network, the following power needs to be reliably supplied to this unit.

Table	Feature	Data
▶	Voltage	380 [VAC] $\pm 10\%$ 3-phase 5 lines (L1, L2, L3, N, PE)
▶	Frequency	50 [Hz] $\pm 1\%$, 60 [Hz] $\pm 1\%$
▶	Breaker	3-phase 4 lines 380V, 30A



- Before making an electrical connection, make sure that the main power supply of the switchboard connecting to this machine is turned off.

Procedure		Electrical connection			
S	Mode	Key	Indication	Step	Reference
1				In this machine, it is necessary to connect the control cabinet to the main power supply. This should be done with proper network grounding.	
2				Due to the main network, power must be supplied reliably to this machine.	
3				Open the electrical panel cover with the appropriate keys.	
End of procedure					

Pneumatic connection

This machine must be connected to the pneumatic system. The required outer diameter of the tube is 10 [mm], the required inner diameter is 8 [mm], and this tube is inserted into the bulkhead connector properly treated beforehand on the bottom of this machine.

Make sure that the route of the tube does not obstruct traffic of people and vehicles.

Provide a refill tube with two valves (1/2 inch recommended diameter). This tube stops the air supply of this machine and discharges it during maintenance work.

The specifications of the compressor are as follows.

Table 4.7.2	Feature	Data
▶	Minimum pressure:	6 [Bar]
▶	Maximum pressure:	8 [Bar]
▶	Air:	Dry air

Connection of water supply and discharge

In order to operate the belt cleaning unit properly, it is necessary to properly connect the tube with the inner diameter of 16 mm to the solenoid valve.

In case of washing water discharge, before starting this machine, make sure that the washing water drain pipe is properly connected and water can be discharged properly.

At the bottom of the tank area there is a discharge valve to open and close the tank drain.

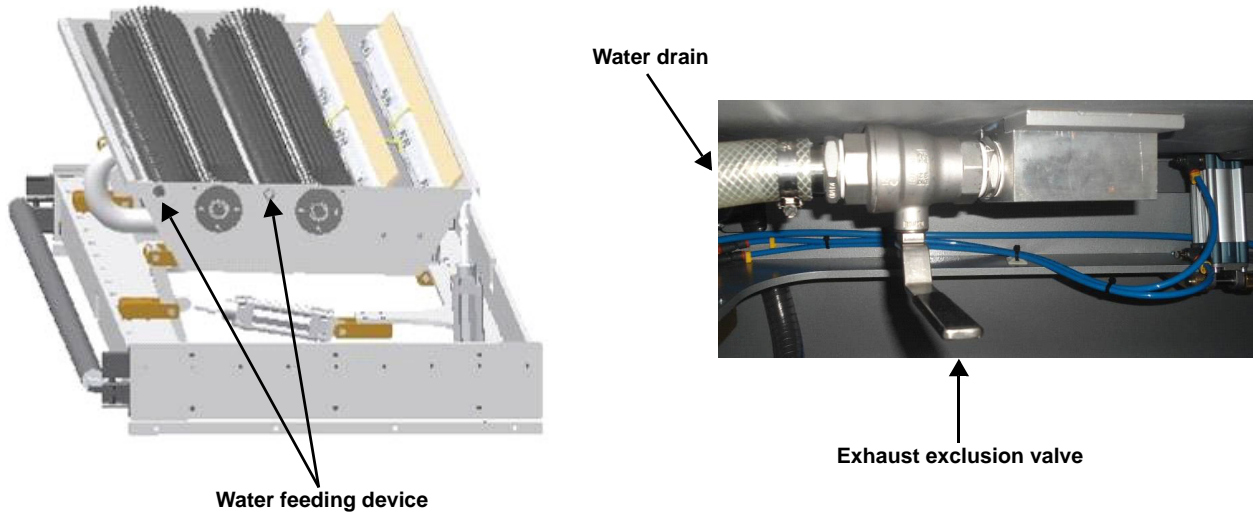

Ground connection

Grounding of the steel structure is ensured by an insulated wire connected to the terminal block of the electrical box and the earth bar.

In the user system, ground protection of all parts of the plant and all equipment circuits must be done by connecting the parts to individual grounding systems.

Make the wiring to the main grounding connection as short as possible so that the grounding conductor is not exposed to the risk of mechanical stress or corrosion.

Make the connection to the main grounding connection as short as possible and make sure that grounding conductors are not subjected to mechanical stress or danger of corrosion.

In order to ensure the safety of people and equipment, it is necessary to observe the following rules.

- Make sure the power supply characteristics are compatible with the technical characteristics of the equipment.
- Connect the power and connecting cables firmly and correctly to the corresponding terminals on the machine.

Connect the shield of the cable to the grounding system above.

The cross section S [mm ²] of the phase conductor of the machine	Minimum cross section of protective earth conductor Sp [mm ²]
$S \leq 10$	$Sp=S$
$16 < S \leq 35$	$Sp=16$
$S > 35$	$Sp=S/2$

Storage Condition

Parts (pin rollers, guide rails, machined parts, etc.) that are subject to oxidation risk at the time of shipment are properly protected with grease or protective spray.

For short-term storage, place it in a dry place to protect it from moisture and check that the packaging is not damaged or completely dry. Do not remove protection applied to various connections.

In case of long-term storage, take additional preventive measures besides the above mentioned method. In fact, it is necessary to repair the lubricated protective layer of all parts which is at risk of oxidation.

To ensure the integrity and functionality of electro circuits and electronic circuits, periodically replace the silica gel according to the moisture content that is present.

Storage location characteristics

When storing, place this machine in a place with the following characteristics.

Indoor with 7000 x 4000 [mm]

Height 4000 [mm]

At the storage location, sufficient mobility and controllability must be ensured so that official approval workers can safely do lifting of equipment safely.



- It is absolutely prohibited to put any substance on the machine.

Chapter 5

Push Button Panel



This chapter

describes the push button panel.

Work Station	5-2
Push button panel (P01)	5-3
Push Button Panel (P02)	5-4
Emergency switch (PEM)	5-4

Work Station

The machine has one PC monitor and four push-button-panels, as shown in the figure below.

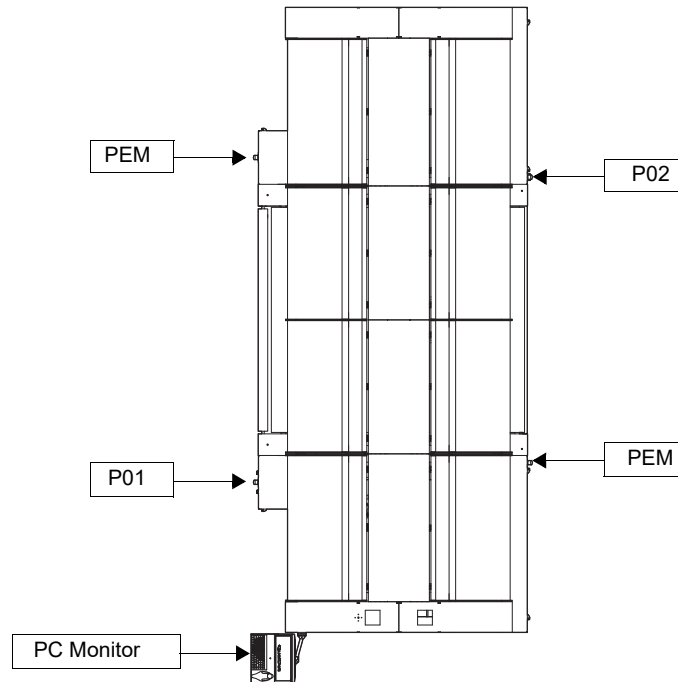

Operation

The operator should stay close to the PC monitor or the button when operating this machine (especially in the following cases).

- Activate the machine with push button
- Confirmation of operation of this machine
- Feed the media roll

Main power supply switch

The main power supply switch is in the electrical box. Except for the upstream area of the main power switch, turn on and off the voltage to each part of the electric panel.

To activate the device, turn the position of the knob to [I] (corresponding to voltage application).

If you need to open the cabinet door, set the knob position to [0].

You can lock the knob so that someone who does not own the key can not use the machine.







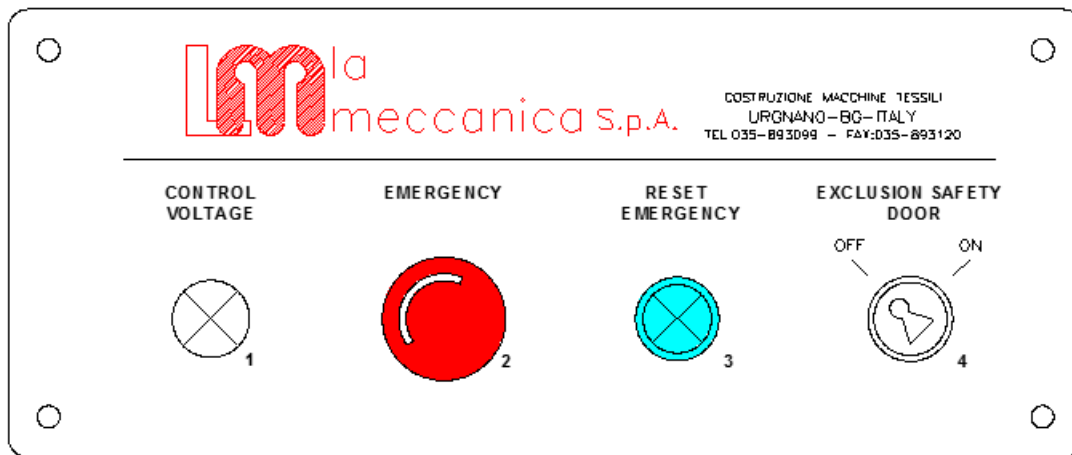

The use of this machine with the guard removed is the responsibility of the maintenance workers themselves. Maintenance workers prohibit others from entering during working. After completing work, confirm that the machine is returned to the normal safe state, and then leave the operation to the machine operator.

Push button panel (P01)

The push button panel (P01) is located on the left side of the PC screen.



Below is a description of the buttons of the push button panel (P01).

			CONTROL VOLTAGE
1			Power supply lamp: When this lamp is lit, power is supplied to this unit and the main switch is turned on.
			EMERGENCY
2			Emergency switch: Press this button to immediately stop the machine and turn off the auxiliary circuit.
			RESET EMERGENCY
3			Emergency reset switch: When this button is lit, the cycle is stopped. After eliminating the cause of the emergency stop, release the emergency switch and press the reset button to reset the emergency stop signal.
			EXCLUSION SAFETY DOOR
4			Safety door switch: Used to release the limit switch which opens the door of the printer. By turning off the switch, you can check the operation of the printer with the door open. Used only for applying the adhesive. <u>Operation is possible only for skilled technicians. Keep the key by department administrator.</u>

Push Button Panel (P02)

The push button panel (P02) is located on the right side of the feeding unit.

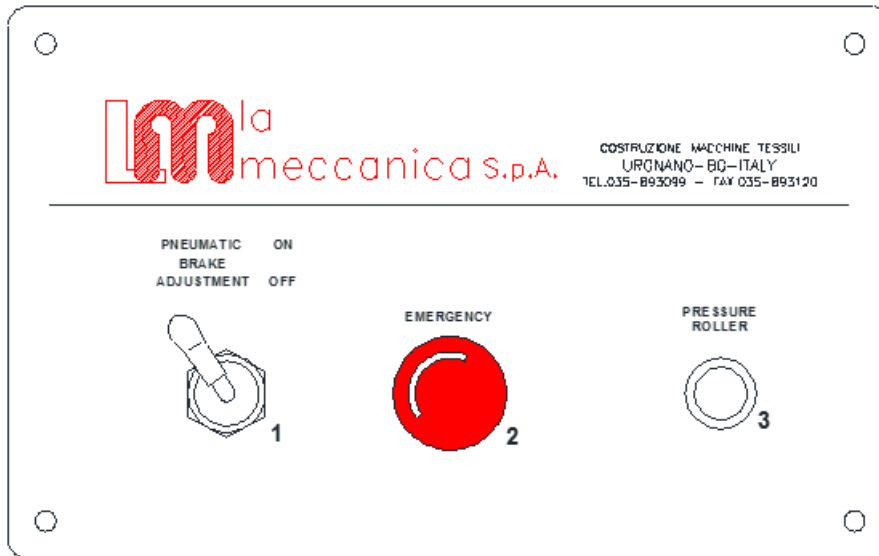

Below is a description of the buttons of the push button panel (P02).

1			PNEUMATIC BRAKE ADJUSTMENT ON - OFF Pneumatic control lever: When tilted upward, adjustment of the pneumatic brake applying tension to the media to be extended becomes effective. If you lower it, this adjustment function will be invalid.
2			EMERGENCY Emergency switch: With this button, you can immediately stop the machine and turn off the power of the auxiliary circuit.
3			PRESSURE ROLLERS Pressure roller button: When this button is pushed, the tension roller at the beginning of the belt moves up.

Emergency switch (PEM)

The emergency switch (PEM) is located on the front left side and on the rear left side of the machine.

1			EMERGENCY Emergency switch: With this button, you can immediately stop the machine and turn off the power of the auxiliary circuit.
---	--	--	---

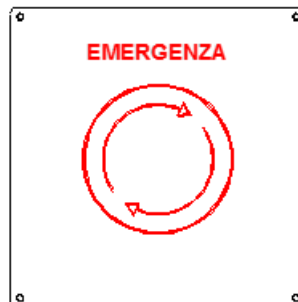

Chapter 6

Basic usage



This chapter

This section describes how to operate this machine with the touch panel.

Introduction	6-2	Cleaning	6-25
Description of screen configuration	6-2	Cleaning at any time	6-25
Status bar	6-3	Auto maintenance setting	6-27
MENU	6-4	Recommended settings	6-27
Explanation of operation method	6-5	Auto maintenance setting screen display	6-27
Touch panel / mouse operation method ...	6-5	Auto maintenance setting	6-28
Each control operation method	6-6	Nozzle recovery	6-30
Explanation of screen when executing		Nozzle recovery flow	6-30
process	6-7	Creating nozzle recovery data	6-31
Explanation of screen when executing		Enable the nozzle recovery function	6-37
process	6-7	MAINTENANCE	6-38
Print operation	6-8	Description of maintenance content	6-38
Description of the print content	6-8	Maintenance content screen	
Print content screen structure	6-8	configuration	6-38
Flow to printing	6-9	Operation of Control panel	6-39
1. Import of a job	6-10	SETTING	6-40
2. Selection of a job to print	6-14	Description of the setting content	6-40
3. Setting of print conditions	6-15	Description of the setting content screen	6-40
4. Start of printing	6-17	Example of setting procedure - Color bar	6-41
Operation during printing	6-18	Feature description	6-42
Pause	6-18	STATUS bar	6-42
Restart	6-19	PRINTER STATUS	6-42
Cancel	6-19	INK STATUS	6-43
Cleaning during printing	6-20	SYSTEM ALARM	6-43
SYSTEM ALARM	6-21	MENU	6-44
Indication when an error is occurred	6-21	Menu configuration list	6-44
Status bar display	6-21	[PRINT] MENU	6-46
Alarm detail display	6-21	[MAINTENANCE] MENU	6-51
Alarm icon	6-22	[SETTING] MENU	6-55
Error description	6-22	[HISTORY] MENU	6-61
Operation restrictions when an alarm		[SYSTEM] MENU	6-62
occurs	6-23	Quick function	6-65
Idling status	6-23		
Printing status	6-23		
How to clear the alarm	6-24		

Introduction

This section describes how to operate the printer and other various operations and settings using the touch panel.

Description of screen configuration

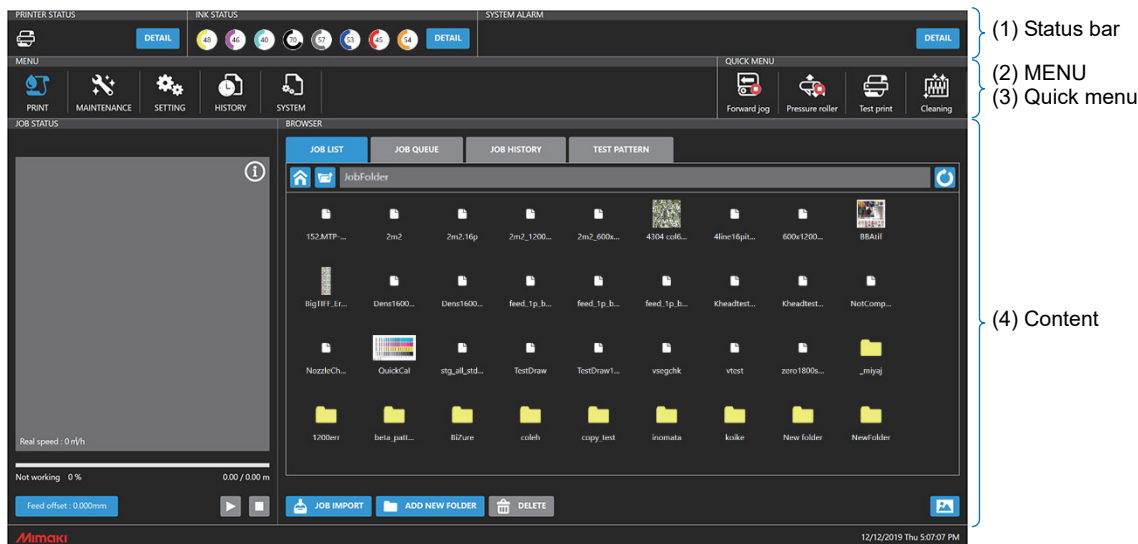

No.	Name	Description
1	Status bar	Shows printer status.
2	MENU	Menus organized by function group.
3	Quick menu	Execute the frequently used functions directly from this screen.
4	Content	Displays the operation screen and information according to the menu.









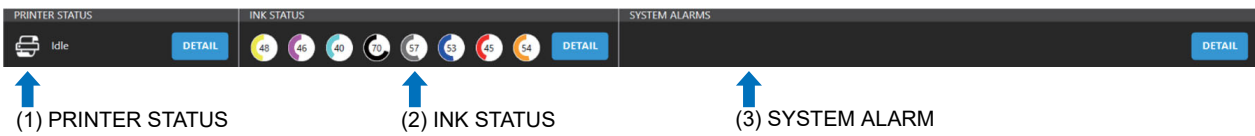





Status bar

Overview

Shows printer status.

Screen description



No.	Item	Description	Explanation
1	<p>PRINTER STATUS</p> 	The icon changes depending on printer status.	<p>Printer status type</p> <ul style="list-style-type: none">  Printing  Pause  Idling  Under maintenance
2	<p>INK STATUS</p> 	Displays ink color and ink remaining for each ink lot in graph and percentage (%). When the ink level is low, an icon is displayed at the bottom right of each ink.	<p>Type of icon indicating the remaining ink level</p> <ul style="list-style-type: none">  Ink near end (remaining ink: 21% to 25%)  Ink end (remaining ink: 0% to 20%)  Ex.) Display at ink end
3	<p>SYSTEM ALARM</p> 	The icon is displayed when an alarm is activated. The details of alarms are described on [SYSTEM ALARM (P.6-21)] .	<p>Type of alarm</p> <ul style="list-style-type: none">  Information  System warning  Error  Fatal error





MENU

Overview

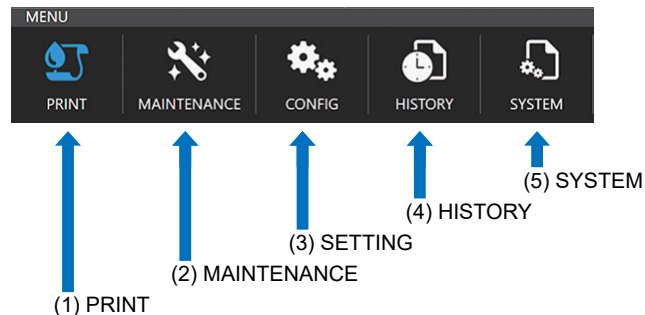
The menu consists of each function group. The function of each selected menu is displayed in the content area.

Screen description









No.	MENU	Description	Main functions
1	PRINT 	Perform the job management and printing operations.	<ul style="list-style-type: none"> • Execution of the print • Job queue • Print operation (pause/restart, cancel) • Print progress display • Manage jobs (import, select, delete) • Reprint from Job history
2	MAINTENANCE 	Printer maintenance menu. Each maintenance is performed in the wizard format.	<ul style="list-style-type: none"> • Cleaning • Head maintenance • Wiper replacement • Cleaning unit maintenance, etc.
3	SETTING 	Printer setup menu. Make various printer settings.	<ul style="list-style-type: none"> • Print quality setting • Printer mechanical setting • Automatic function setting, etc.
4	HISTORY 	Shows the system history.	<ul style="list-style-type: none"> • Print history • Each maintenance history • Alarm history • Controller history
5	SYSTEM 	Displays the system information and system configuration.	<ul style="list-style-type: none"> • Language setting (Japanese, English) • System configuration/information display • Version information • Licensing information • PC shutdown/reboot • Displaying application notes, etc.

Explanation of operation method

Touch panel / mouse operation method

This touch panel can be operated with a mouse.







No.	Controller	When to use	Touch panel	Mouse
1	Select	<ul style="list-style-type: none"> Select a job to print Select a menu Select setting or operation items, etc. 	Operation: Tap 	Operation: Left click 
2	Press and hold	<ul style="list-style-type: none"> Select a job to import Select a job to delete 	Operation: Press and hold 	Operation: Right click 
3	List scroll	<ul style="list-style-type: none"> Scroll a job list Scroll history etc. 	Operation: Swipe 	Operation: Mouse scroll 

This manual describes the operation instructions using the touch panel.

For the mouse operations, refer to the above table and replace touch panel operations with mouse operations.

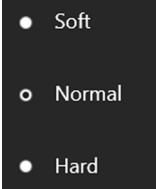
Each control operation method

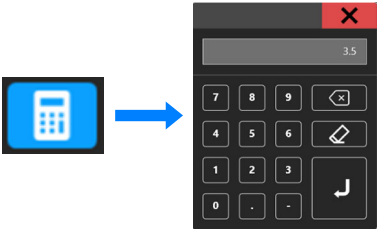
This section describes how to operate each item.

No.	Control name		When to use
1	ON/OFF Switch	 ON setting  OFF setting	When selecting ON / OFF
2	Radio button		When selecting one of multiple options
3	Input number + / -		When entering number
4	Input number Numeric keypad		When entering number
5	Software Keyboard		When entering alphabets and symbols

Explanation of screen when executing process

This section explains the processing screen when processing is executed.

Explanation of screen when executing process

Transition of screen when executing process

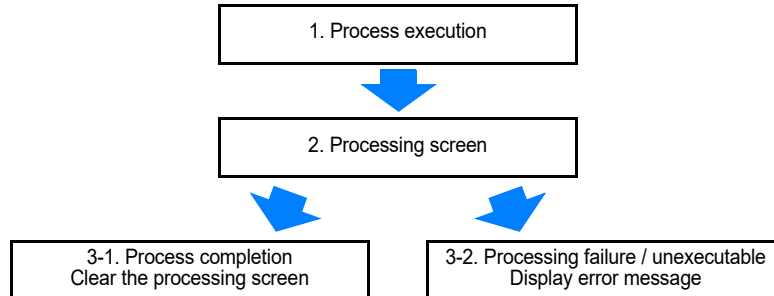

Processing screen

Displayed during processing execution, and the progress is displayed when executing long processing.



While the processing screen is displayed, other operations are not accepted to prevent misoperation.

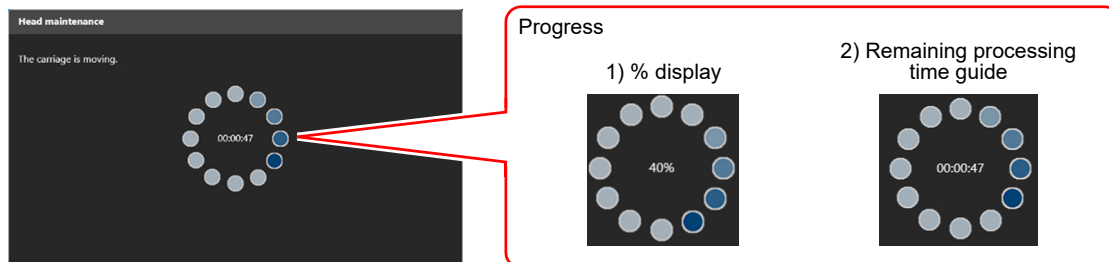

Processing screen

A message is displayed when processing fails or when processing is not possible.

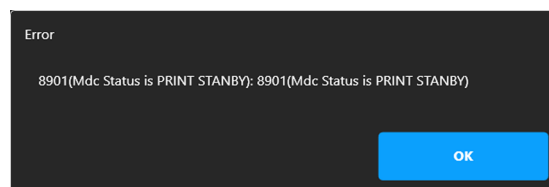

Execute processing again according to the message content.

Print operation



This section describes the job management and print operation procedure of the selected job.

Description of the print content

Print operation is performed from the Print menu.

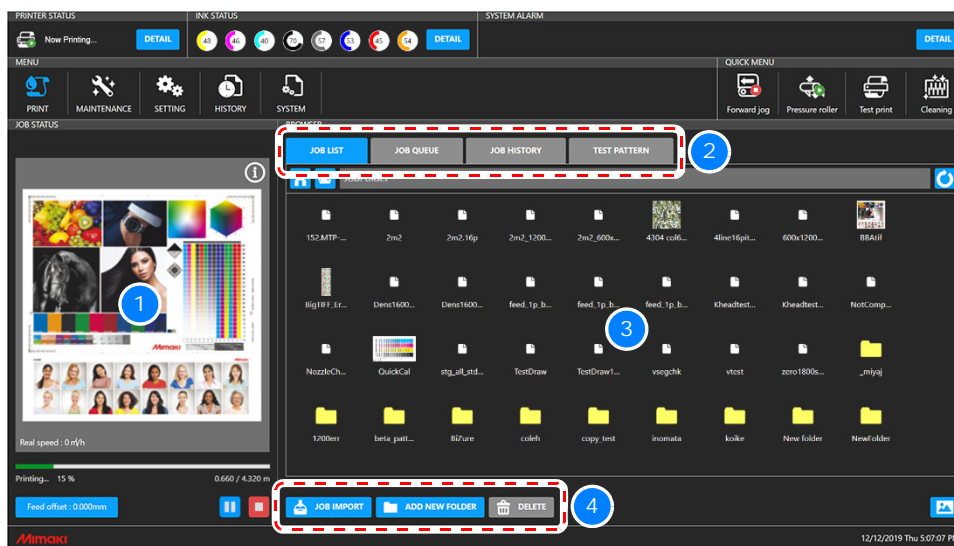
Print content screen structure



No.	Item	Description
1	Print status area	<p>The print status is displayed.</p> <ul style="list-style-type: none"> Job information during printing (thumbnail) Print status (progress) Pause/restart or cancel during printing  Pause  Restart  Cancel
2	Job management tab	<p>Manages jobs.</p> <ul style="list-style-type: none"> JOB LIST: Print job selection, job import / deletion JOB QUEUE: List of jobs waiting to be printed JOB HISTORY: Printed job history (Jobs can be reprinted from the history) TEST PATTERN: Built-in test pattern (including adjustment pattern)
3	Job list area	<p>Displays a list of jobs for each job management tab. Select a job to print from the list.</p>
4	Job operation button	<p>Displayed when the JOB LIST tab is displayed, and imports, deletes, and creates folders.</p>

Flow to printing

Print a job created with the RIP application by the following procedure.

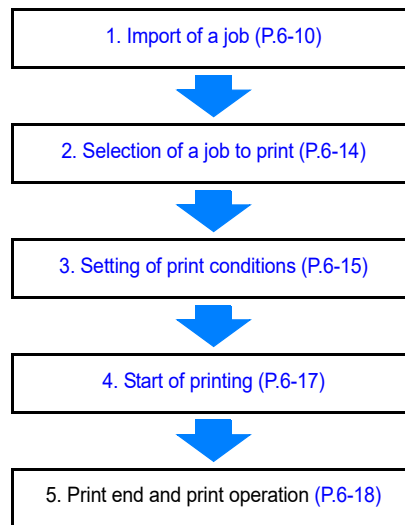

Please check the following before printing.

- Perform a test print and check the nozzle status. Perform cleaning if necessary.
- Make sure that the pressure roller is descending and pressing the media.
- Check the ink level and media level.
- Check whether an alarm has occurred.
If an alarm has occurred, remove the cause of the alarm and clear the alarm.

1. Import of a job

When printing, import the job to the internal PC.

This section describes how to import a job from a removable disk and how to import through a network.



You can directly select a job on a removable disk, but it is recommended that you perform an import before printing, as printing may be delayed.

- Delay :
There is a delay in data transfer, and there is a possibility that the print will be delayed by about 1 second for each scan.

1-1. Import from the removal disk

Import the job created with RIP to the PC with the internal PC according to the following procedure.

1 Insert the removable disk (USB memory) into the internal PC.

- Insert the removable disc containing the job into the USB port of the internal PC.



USB with password is not supported.

2 Tap the [JOB IMPORT] button.

- After selecting a job, tap the [JOB IMPORT] button to display the <Import> dialog.

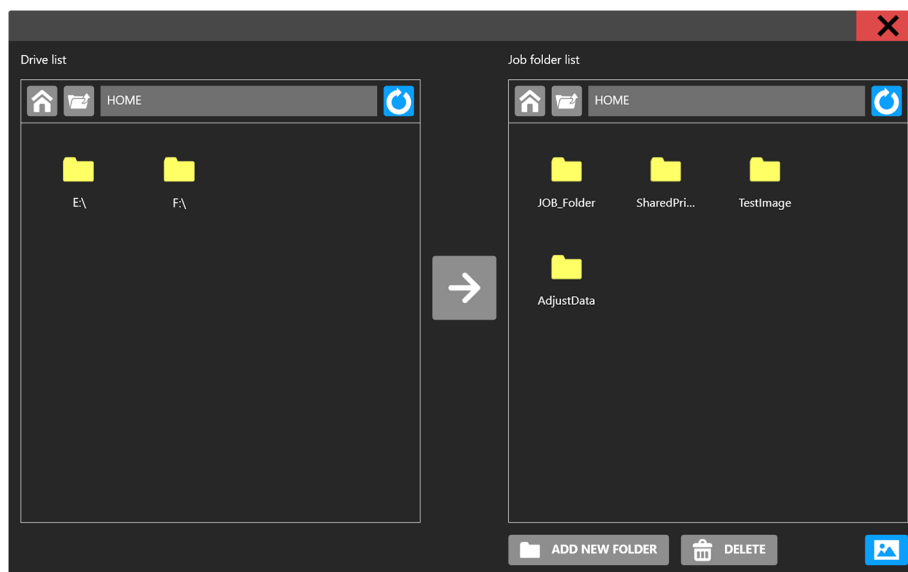
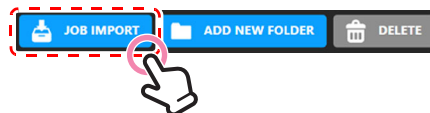

<Import> dialog

3 (Left screen) Select the job to be imported.

- Move to the folder that contains the job you want to import and press and hold the job to select.

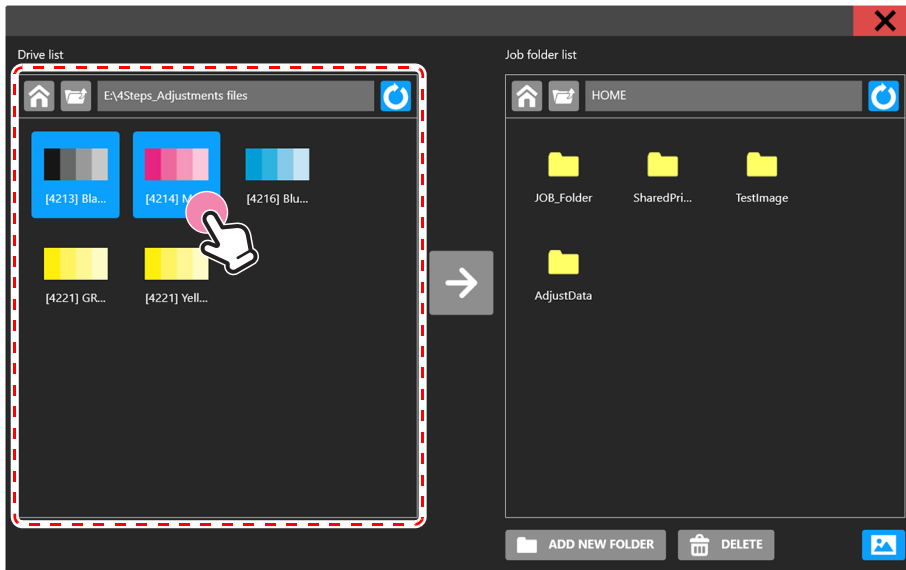

4 (Right screen) Specify the import destination.

- Move to the folder where you want to copy the job.

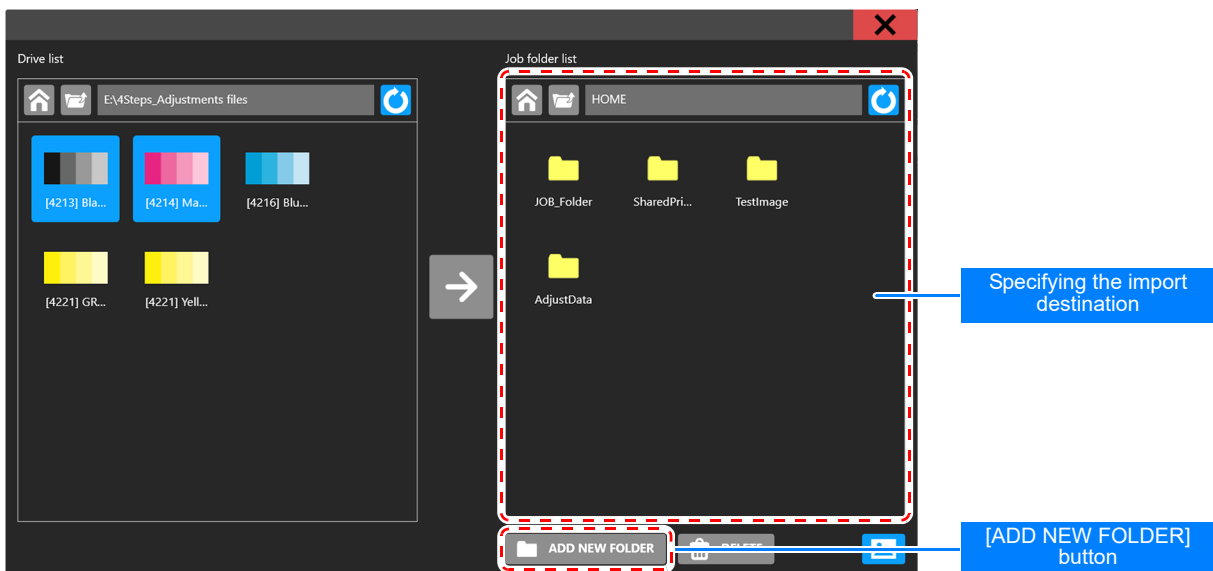

Click [ADD NEW FOLDER] to pop up <Create folder> dialog.

Enter the folder name on the screen and tap the [Enter] key to create a folder with the entered name and close the <Create folder> dialog.



<Create folder> dialog



If the folder name is not entered, a folder named “NewFolder” is created.
 If a folder with the same name already exists, the <Create folder> dialog will be closed without creating a new folder.

5 Perform import.

- After setting the job to be imported and the import destination, tap the [Execute] button in the center of the dialog.
- The job is copied from the removable disk to the specified path.
- The transfer speed depends on the size of the job to be transferred and the performance of the removable disk.

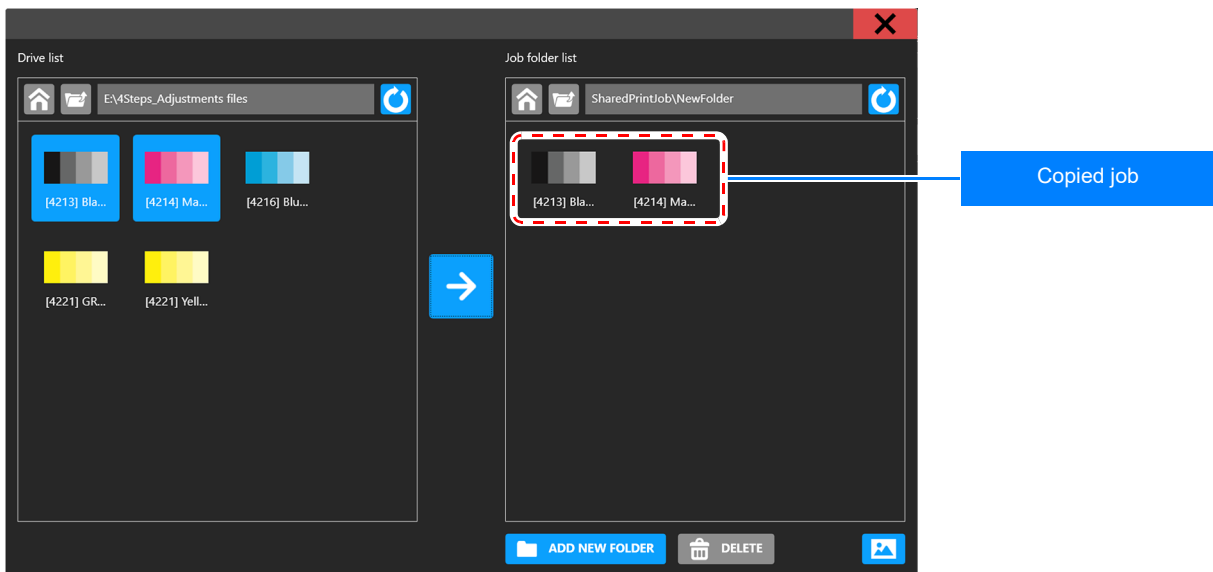
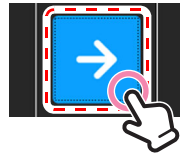

1-2. Import from network.

A network shared folder is set in the printer's internal PC. Jobs can be imported to the shared folder from another PC connected to the LAN.

The recommended import method is described below.

- Transfer the RIP-completed job folder to the shared folder [SharedJob] on the internal PC.

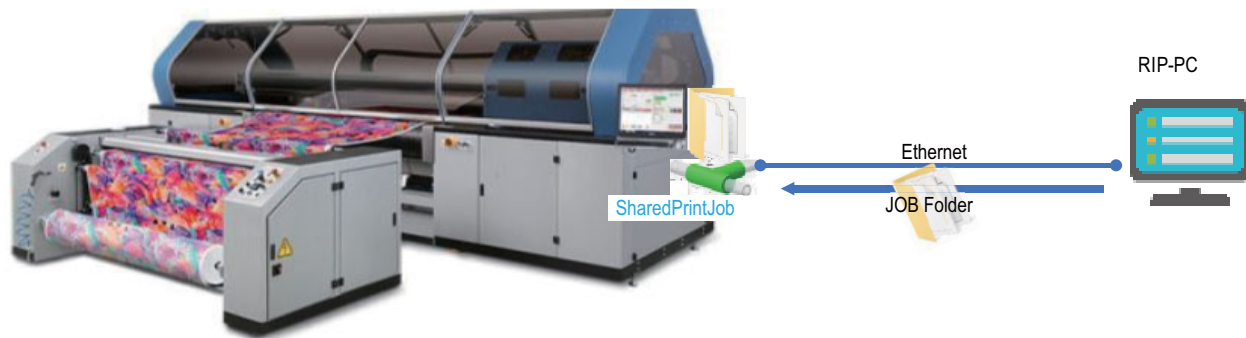

Depending on the network environment, import may not be possible. In that case, contact your network administrator.

1 Search the shared folder of this machine. (Operate from other Windows PC)

- Use the network search function to search for the computer name "TIGERMK2" from the import source PC (RIP PC, etc.), or search for the shared folder by specifying the IP address of this machine.

2 Import the job to the shared folder.

- Copy the job to the "TIGERMK2" shared folder, [SharedJob].

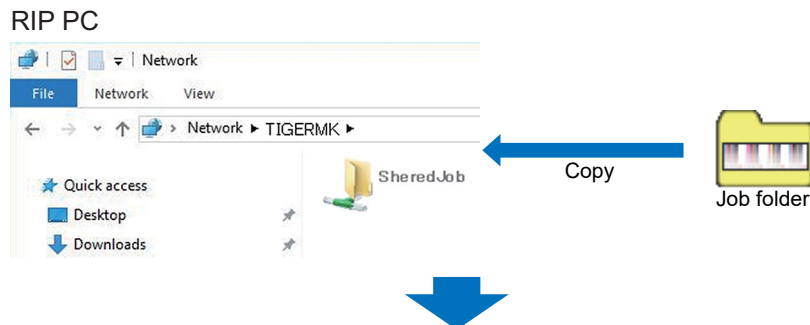

The copied job can be printed from the [SharedJob] folder in the [PRINT] menu > [JOB LIST] tab.

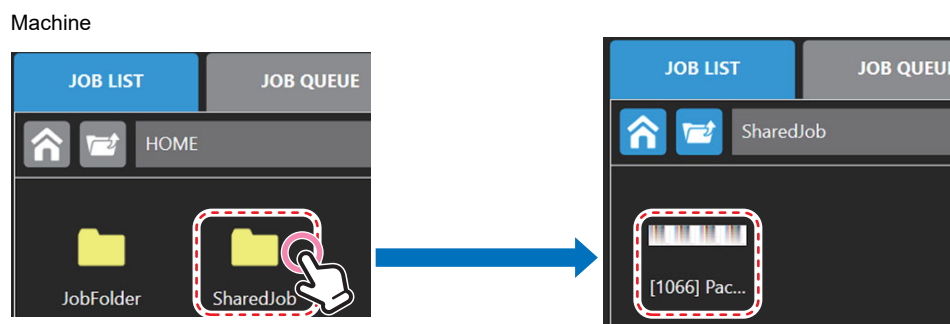

2. Selection of a job to print

Tap the job to be printed from the Job list area to display the <Print condition selection> dialog.



If a job displayed in the JOB LIST tab or JOB HISTORY tab is deleted from the PC, the dialog will be displayed, but an error will occur when you execute printing.

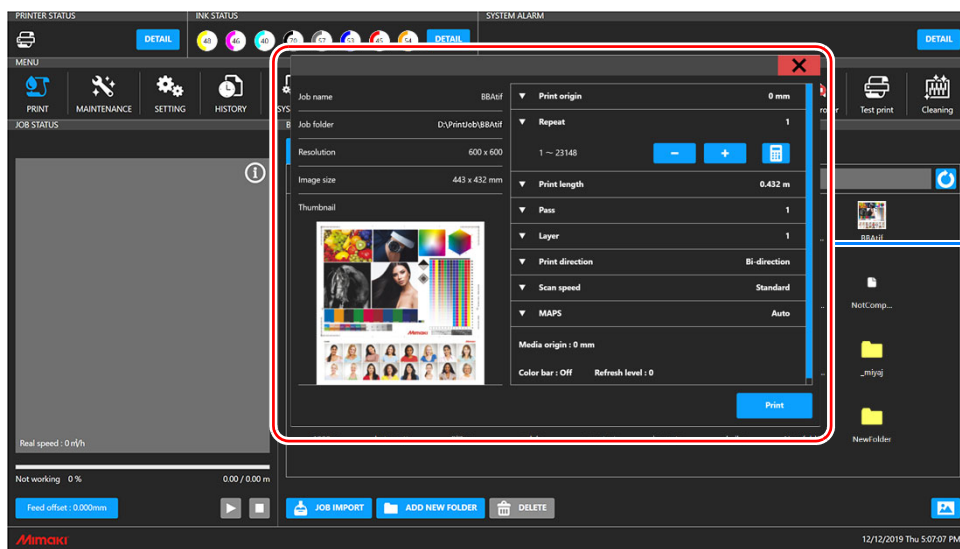
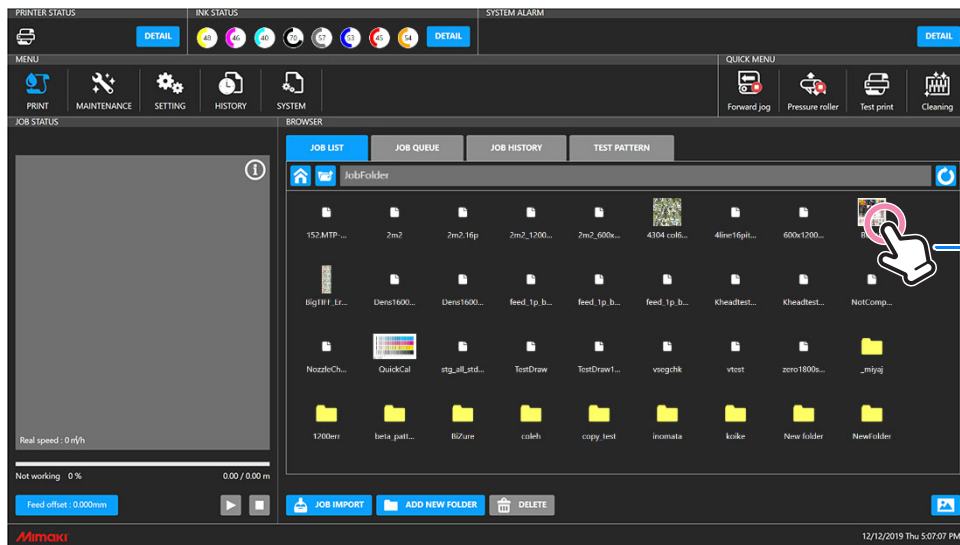

3. Setting of print conditions

Enter a condition in the <Print condition selection> dialog to start printing.

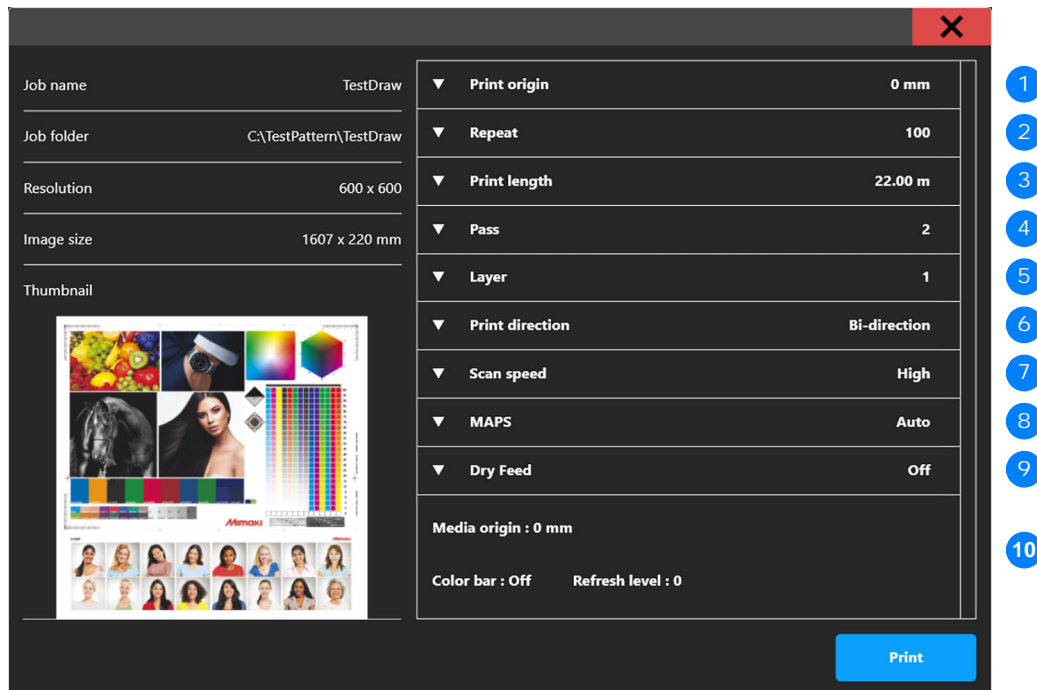

<Print condition selection> dialog

No.	Setting item	Description of settings and range of input values
1	Print origin	Specify the print origin based on the media origin. <ul style="list-style-type: none"> • Input range: 0mm to MAX1600mm * MAX varies depending on image width • Enter the value of the left position to start printing from the media origin
2	Repeat	Specify the number of times to print the selected job repeatedly. <ul style="list-style-type: none"> • MAX : Print length x repeat setting = 10000.00 m or less ^{*1}
3	Print length	Specify how many meters the selected job will be printed. <ul style="list-style-type: none"> • Input range: Image height ~ 9999.00 m ^{*1}
4	Pass	Specify the pass. <ul style="list-style-type: none"> • 1 - 4 (pass) • The number of pass available depends on the job's resolution. Ex.) When the value is 1200 dpi, it can be used with two or more passes.
5	Layer	Specify the layer (number of layers). <ul style="list-style-type: none"> • 1 - 4 (layer)
6	Print direction	Direction of scanning to be printed is specified. <ul style="list-style-type: none"> • Uni-direction / bi-direction
7	Scan speed	Specify the scan speed. <ul style="list-style-type: none"> • High speed (fast) / standard (standard speed) * High speed cannot be selected for big dot job data. * If you set the high speed job to the standard setting, the print speed will be slower.
8	MAPS ^{*2}	Specify the MAPS. 1) Setting: Auto (Recommended) Manual (Apply the following input value) 2) Speed: 50% to 100% The closer to 50%, the lower the print speed. Determine the value according to the job and image quality. 3) Smoothing: 0% to 100% Reduce the density differences in the overlapping prints. The closer to 0%, the thicker the density. * It is necessary to adjust to the optimal density depending on the media type.
9	DryFeed	Set the dry feed ON/OFF. <ul style="list-style-type: none"> • On / Off
10	Setting information display	The following information set in the setting menu is displayed. Check the contents before printing. <ul style="list-style-type: none"> • Media origin • Color bar * To change the setting, use the setting menu.

*1 Each repeat and print length varies depending on the set value and image size.

*2 MAPS:

MAPS function (Mimaki Advanced Pass System) is a function that disperses the boundary of the pass and makes the feed stripe inconspicuous. Depending on the printing conditions, such as 1 pass printing, the MAPS mask may be visible.

4. Start of printing

After specifying the print conditions, tap the [Print] button to start printing.

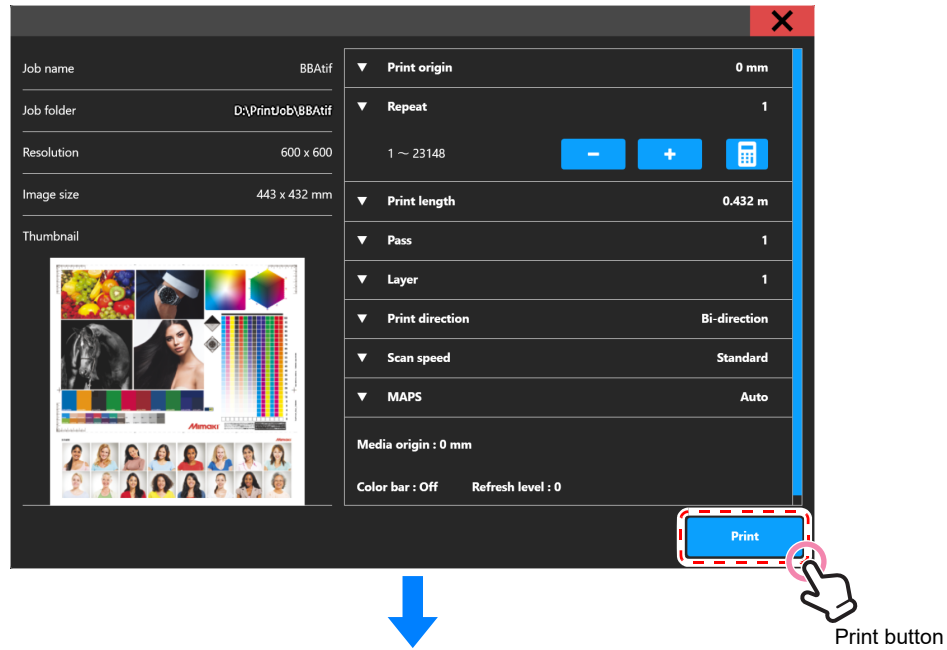

When printing starts, the <Print condition selection> dialog box is closed and the job information and progress being printed are displayed in the JOB STATUS area.

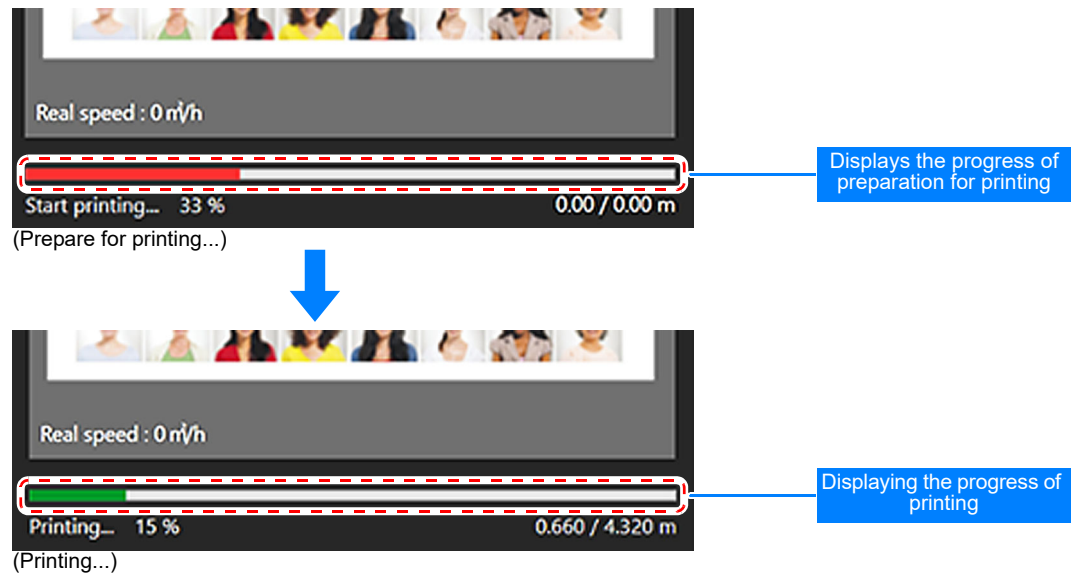

Operation during printing

You can pause/restart or cancel printing by tapping the [Print operation] buttons.

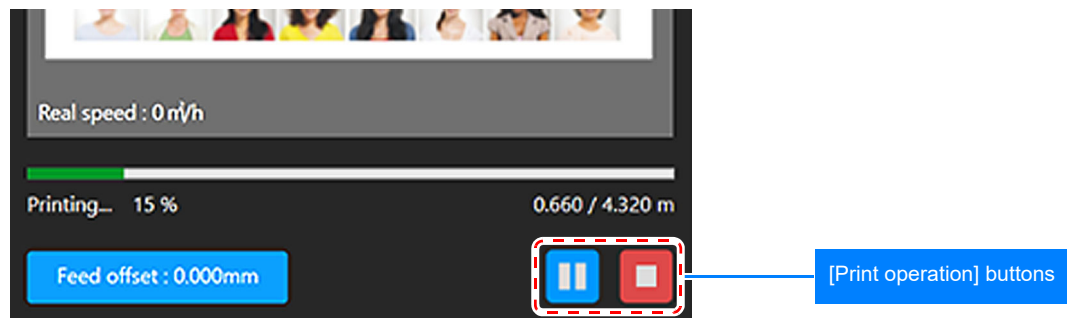

Pause

Pause the print operation.

Tap the [Pause] button in the Print status field.

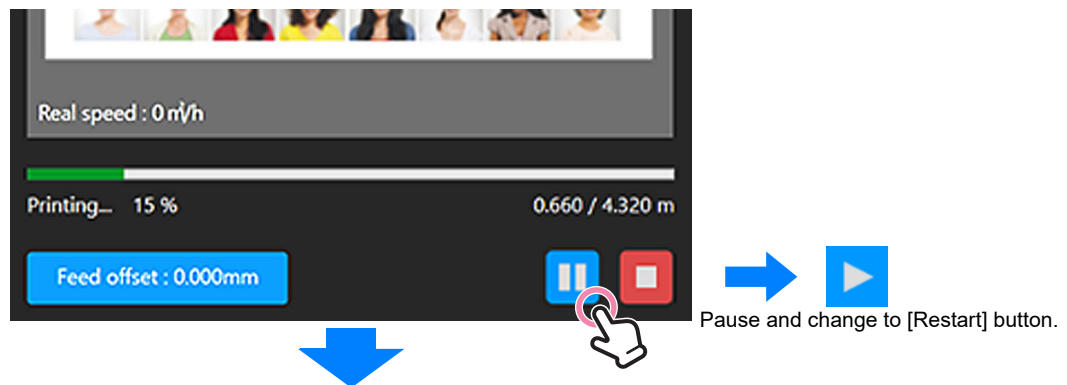

The processing screen is displayed until the pause is completed. -> Completed

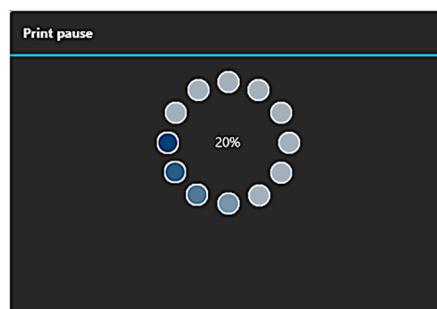

<Print pause> dialog

When the pause process is performed, the carriage returns to the station.

When the carriage returns to the station, the process is completed.



If the [Pause] button is tapped in the bi-direction print mode, printing is performed for the return path and then stopped.

Depending on the timing of tapping the [Pause] button, it will stop after one round-trip printing.

Restart

Restarts printing of the paused job.

Tap the [Restart] button in the JOB STATUS field.

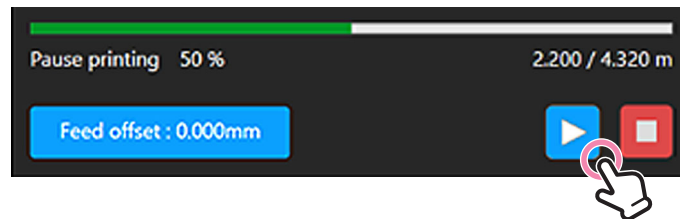

Cancel

Cancels the print.

Tap the [Cancel] button in the JOB STATUS field.

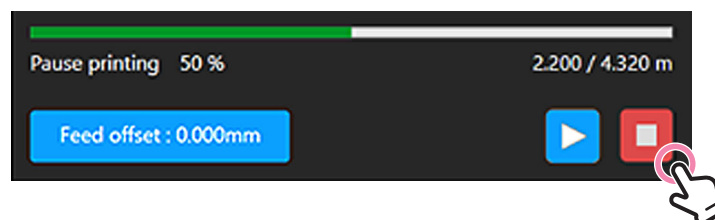

The processing screen is displayed until the cancellation is completed. -> Completed

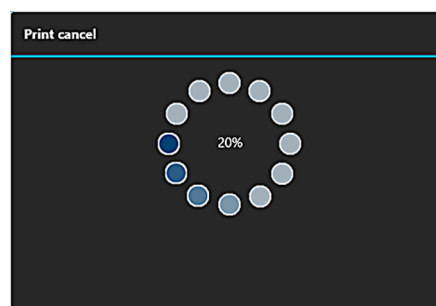

<Print cancel> dialog

After canceling, the carriage returns to the station.

When the carriage returns to the station, the process is completed.



After canceling, if there are waiting jobs in the JOB QUEUE, the information of the next job is displayed in the JOB STATUS field.

Tap the  [Restart] button to print the next job.

Cleaning during printing

Cleaning can be performed at any time during printing.

Perform cleaning from the QUICK MENU or MAINTENANCE MENU.

Refer to “[Cleaning at any time \(P.6-25\)](#)” for cleaning.

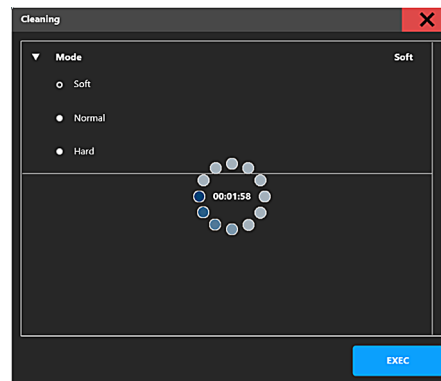

After the pause, the carriage returns to the station and cleaning is performed.



After the cleaning is completed, printing resumes automatically.

SYSTEM ALARM

The SYSTEM ALARM field displays the alarm information that occurred on the machine.
This section describes an error indication and corrective actions.

Indication when an error is occurred

When an error occurs, an alarm icon and error details are displayed in the [SYSTEM ALARM] area. If you tap the [DETAIL] button when an alarm occurs, the detailed information and the [CLEAR ALARM] button will be displayed and you can clear the alarm.

Status bar display

An alarm icon is displayed in the color corresponding to the error level in the [SYSTEM ALARM] in the status bar.



In this area, the error with the highest error level and the latest occurrence time is displayed.

Alarm detail display

Tap the [DETAIL] button in the [SYSTEM ALARM] area to display all the errors that have occurred.

How to display the alarm details screen

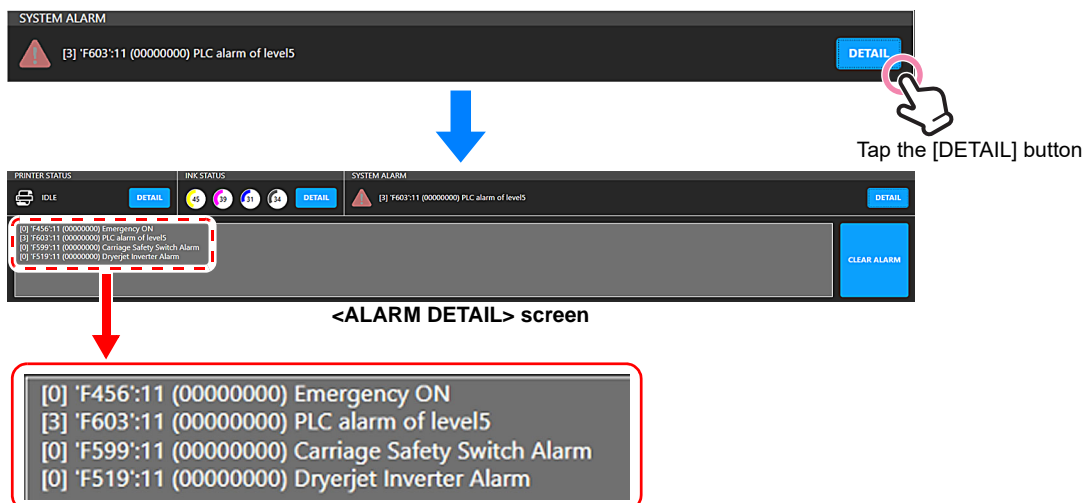

Alarm icon

Information (error level: 0)

Icon color	Alarm content	Handling method
Blue 	Occurs when treatment is required, such as ink near end. Continue printing.	Check the alarm details and take action according to the information.

System warning (error level: 1)

Icon color	Alarm content	Handling method
Yellow 	Occurs when treatment is required, such as ink end. Pause the print operation.	You can resume printing after performing the necessary measures and clearing the alarm.

Error (error level: 2)

Icon color	Alarm content	Handling method
Orange 	Occurs when the printing cannot be continued due to ink overflow etc... The print is canceled.	You can resume printing after performing the necessary measures and clearing the alarm.

Fatal error (error level: 3) * Includes critical condition

Icon color	Alarm content	Handling method
Red 	Occurs when the printing operation or operation cannot be performed due to an emergency or the system halt occurs. It will be in an emergency stop state and will stop working	Take the necessary action and register the job again after clearing the alarm.

Error description

The contents of the displayed error are as follows.

[2] 0602:09 (__3__) INK END
(1) (2) (3) (4)

How to read error contents		
1	Level	Error level (0-3)
2	Code	Error code
3	Unit	Error unit number
4	Contents	Error Information

Operation restrictions when an alarm occurs

When an error occurs, the operation is restricted according to the error level. This section describes the operation according to the printer status and error level.

Idling status

If an error occurs in the idling state, the operation is restricted according to the error level.

Level	Operation restriction	Description
0	All operations are possible.	Check the information and perform each operation.
1	Cannot start printing.	An error that cannot start printing has occurred. Remove the cause of the error and start printing after clearing the alarm.
2, 3	Cannot start printing. Other operations cannot be performed. (Depends on error details)	Printing cannot be started or a critical error has occurred. Depending on the content of the error, other operations cannot be performed. Remove the cause of the error, clear the alarm and perform each operation.

* Cleaning is restricted when an ink supply system error other than Level 0 occurs.

Printing status

If an error occurs during printing, the printing operation is paused or stopped according to the error level.

Level	Operation details	Description
0	Printing continues.	If action is required, pause or cancel.
1	Printing is paused.	An error such as an ink end that requires action to continue printing has occurred. Remove the cause of the error, clear the alarm and restart printing. * Printing resumes from where it left off.
2, 3	The print is canceled.	An error such as a jam that cannot continue printing has occurred. Remove the cause of the error, clear the alarm, select the job again, and start printing. * Printing starts from the beginning of the selected job again.



When an error occurs, check the error code contents in the error list (Chapter 9) and perform the specified action. ([[Error list \(PLC\) \(P.9-5\)](#)], [[Error list \(Other\) \(P.9-18\)](#)])
If the situation does not improve after implementing the measures, contact your local distributor, our sales office, or service center.

How to clear the alarm

When an error occurs, take action according to the error level, and then clear the alarm from the alarm details screen.

Tap the [CLEAR ALARM] button.

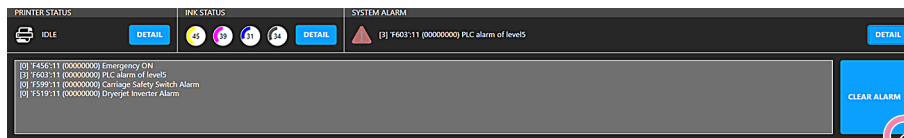

Tap the [CLEAR ALARM] button

The processing screen is displayed until the alarm clear is completed. -> Completed

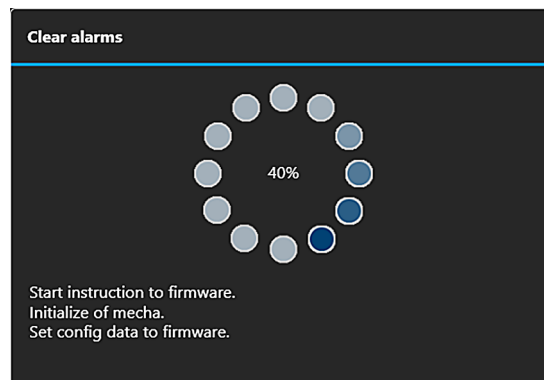

<CLEAR ALARM> dialog

If the alarm clear is successful, the <CLEAR ALARM> dialog closes and the alarm information displayed on the alarm details screen is cleared.

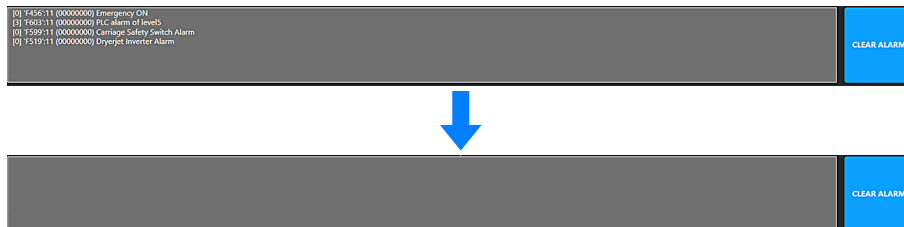

If an incorrect or inadequate action is taken, the alarm cannot be cleared and the alarm may be displayed again. In such a case, take the action according to the error description again.



If operation of the machine is unstable even after clearing the alarm, reset the machine from the [SYSTEM] > [Power] > [Reset machine] menu.

Cleaning

This section explains about Head cleaning.

* Auto cleaning setting during standby or printing is performed from the [SETTING] menu.

Cleaning at any time

It is performed when the nozzle check result in the test print is bad or when a nozzle clogging is found during printing.



When cleaning can be performed

- 1) When the printer is in idle
- 2) During printing (Can be executed without pausing operation.)



Regardless of the timing, the system automatically performs cleaning while waiting and printing at regular intervals. ([Auto maintenance setting (P.6-27)])

1 Open the cleaning execution screen.

1. Open from the QUICK MENU.

From the quick menu, select [Cleaning].

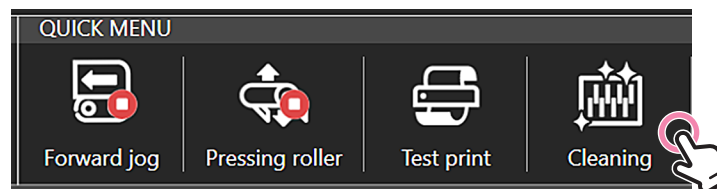

2. Or open from the MAINTENANCE MENU.

Select [Cleaning] from the [Cleaning] in the Maintenance list.

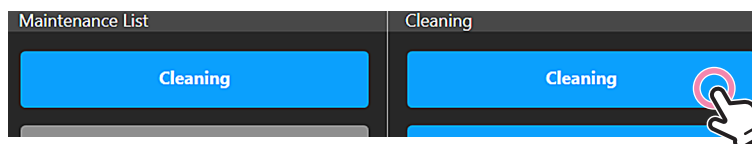

The cleaning execution screen is displayed by the above operation (1) or (2).

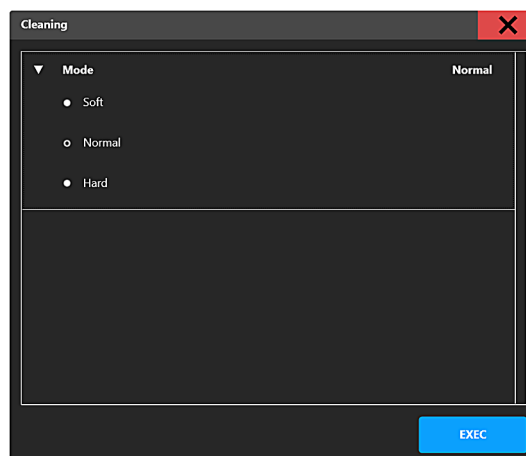

2

Select the Cleaning Mode.

- Select a cleaning mode from the Mode selection field on the cleaning execution screen.

**Main application of each cleaning mode**

No.	Mode	Application	Time required
1	Soft	When refreshing the nozzle surface, such as before printing	about 50 seconds
2	Normal	When multiple nozzles are clogging	about 1 min.
3	Hard	If nozzle clogging is not recovered by normal cleaning, there is a lot of nozzle cloggings or when filling the head	About 1 minute 30 seconds

3

Perform the cleaning.

- Execute cleaning from the execution button in the cleaning execution screen.

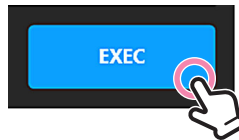

- Cleaning starts and the cleaning screen appears.
- When cleaning is completed, the cleaning screen disappears.

Auto maintenance setting

By using Auto maintenance, cleaning is automatically performed during printing or idling, and the nozzle condition is maintained or improved.

The cycle starts when Auto maintenance is set.

- If cleaning is performed at any time, the cycle will be restarted.

Recommended settings

The following is the recommended setting for ensuring ejection stability.

Ink type	Printing		Idling		
	Mode	Interval Print time [min]	Mode	Flushing Times	Time [min]
MLRc500	Normal	30	Normal	3	30
MLSb510	Normal	30	Normal	3	30
MLSb520	Normal	30	Normal	3	30

- Auto-cleaning during printing can be set according to the distance, but it is recommended to set according to the time because the timing differs depending on the drawing mode.

Auto maintenance setting screen display

Select [Auto maintenance] > [Cleaning (Print)] or [Cleaning (Idle)] in the MAINTENANCE MENU to display the setting screen.



Auto maintenance setting

Auto maintenance setting in idle

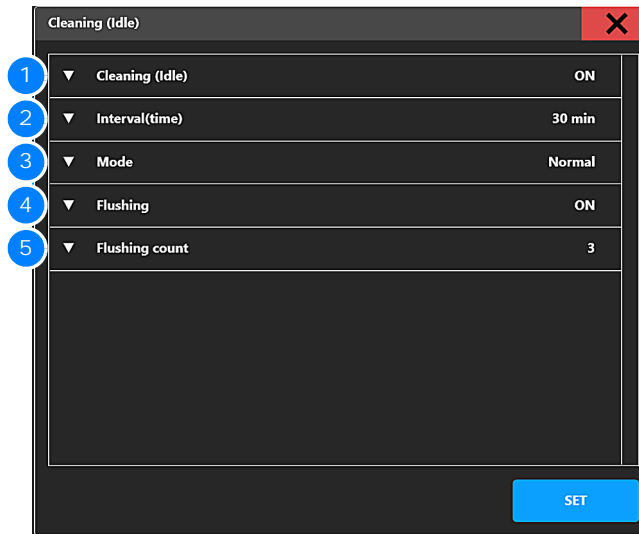

No.	Description
1	Auto maintenance in idle On / Off
2	Time cycle (min)
3	Cleaning mode (Soft, Normal, Hard)
4	Flushing between cleanings On / Off
5	Flushing count when 4 is set

● Setting example)

Time: 30 minutes, Flushing: On, Flushing frequency: 3 times

After setting, flushing is performed every 30 minutes, and cleaning is performed 2 hours after setting.

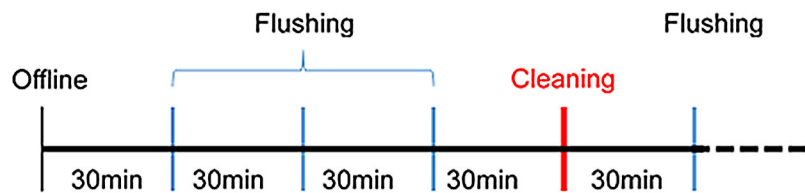

Auto maintenance setting during printing

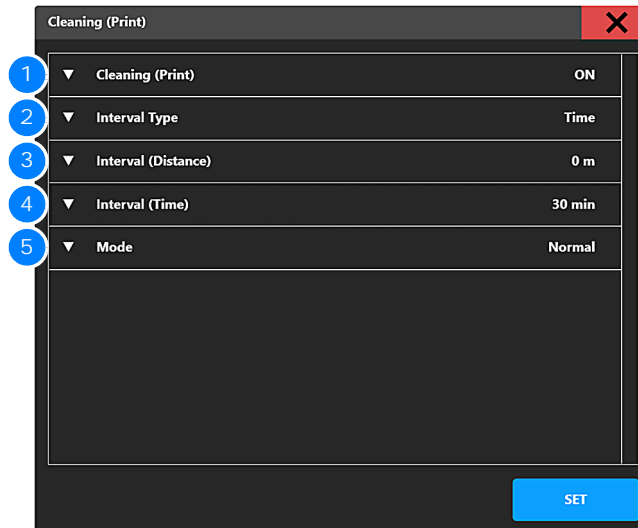

No.	Description
1	Auto maintenance during printing On / Off
2	Select the cycle type of the print distance / print time
3	Print length (m) when selecting the print length in 2
4	Printing time (min) when selecting the print time in 2.
5	Cleaning mode (Soft, Normal, Hard)

Nozzle recovery

When nozzles missing cannot be improved by cleaning, other normal nozzles can be used as alternatives for printing; Nozzle recovery system (NRS).



Nozzle recovery is applied only during multi-pass printing.

(600 x 600 dpi 2 passes or more, 600 x 1200 dpi 4 passes or more, 1200 x 1200 dpi 4 passes or more)

- Depending on the created recovery nozzle, the recovery may not be applicable.

Nozzle recovery flow

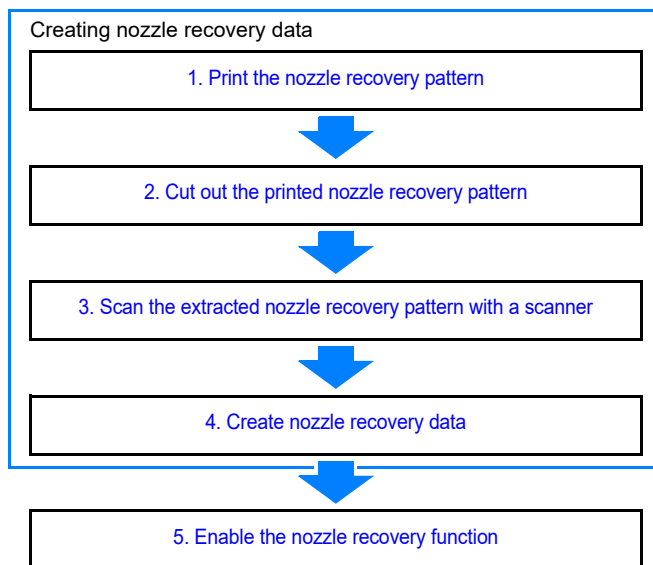

Creating nozzle recovery data

This section describes how to create nozzle recovery data from a nozzle recovery pattern.

Print the nozzle recovery pattern

1 Set the media for printing nozzle recovery pattern

- Set the dedicated media for nozzle recovery (white PET or Mimaki Vision Jet-X-162) in the print area.

2 Select the nozzle recovery pattern.

1. Select the [PRINT] menu
2. Select the [TEST PATTERN] tab
3. Press [Home] button
4. Select the Adjust Draw folder

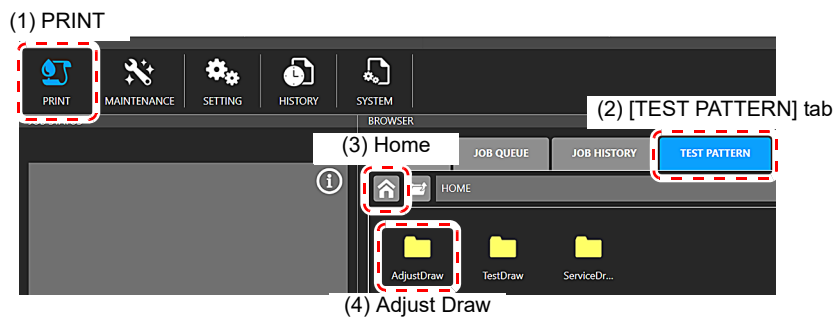

5. Select the [NozzleRecovery] folder



6. Select the NozzleRecovery pattern

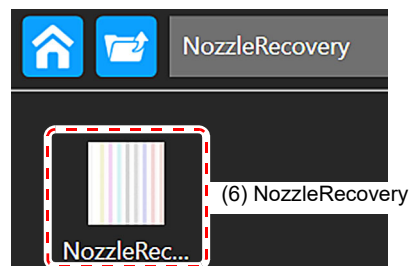

3 Print the Nozzle recovery pattern

- Print the selected Nozzle recovery pattern.



Do not change the settings of Pass, Layer, Print direction, Print Speed, or MAPS settings. Otherwise, the pattern may not be printed properly.

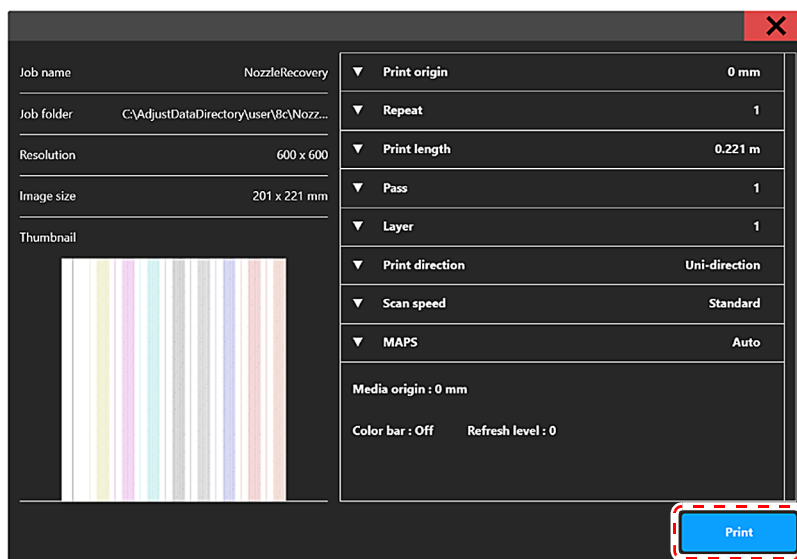

Cut out the printed nozzle recovery pattern

The nozzle recovery pattern shown below (pattern of the 4-color model) is printed.

To scan with the scanner, cut out the pattern along the cut line on the periphery of the pattern.



Cut out the pattern along the cut line. Otherwise, the analysis process to detect missing nozzles may fail.

Scan origin



Cut line (outer periphery)



Scan the extracted nozzle recovery pattern with a scanner

Read the extracted nozzle recovery pattern into the internal PC with a scanner.



Read the nozzle recovery pattern using the attached scanner.
if use the other scanner the analysis process to detect missing nozzles may fail.

1 Start the scanning application attached to the scanner

- Start the scanning application from [SETTING] > [Nozzle recovery] > [Scanner] menu.

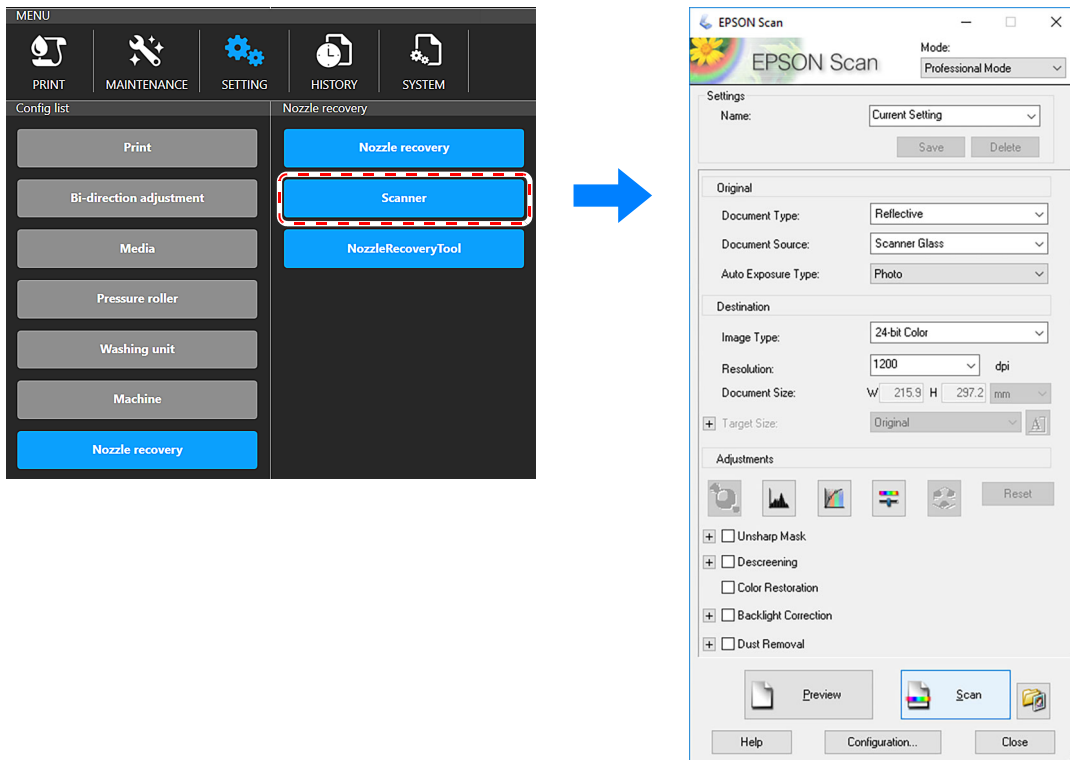

2 Set the nozzle recovery pattern on the scanner

- Set the origin of the nozzle recovery pattern to the origin of the scanner.



Note the origin of setting the nozzle recovery pattern in the scanner. If the origin of the scanner and the origin of the pattern do not match, the analysis process to detect missing nozzles may fail.

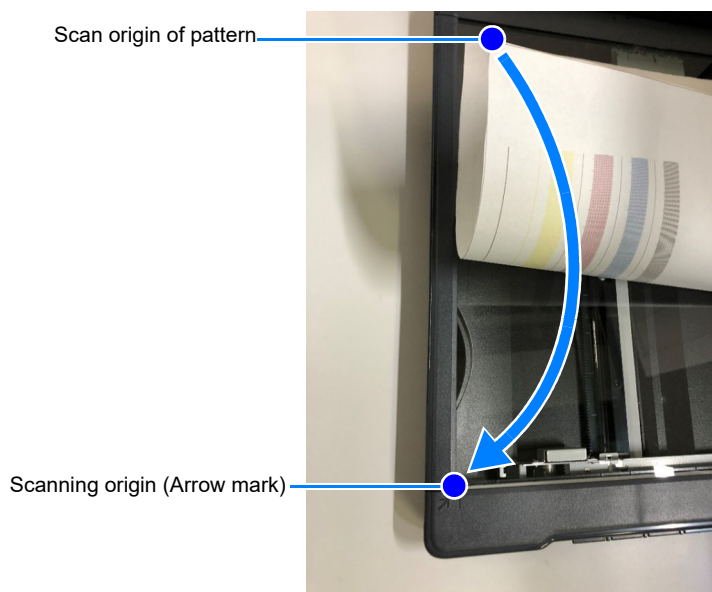

3 Reading the nozzle recovery pattern

1. Scanner setting

Item	Settings
Resolution	1200dpi
Read format	BITMAP
Others	Make settings so that no processing is added to the scanned image.

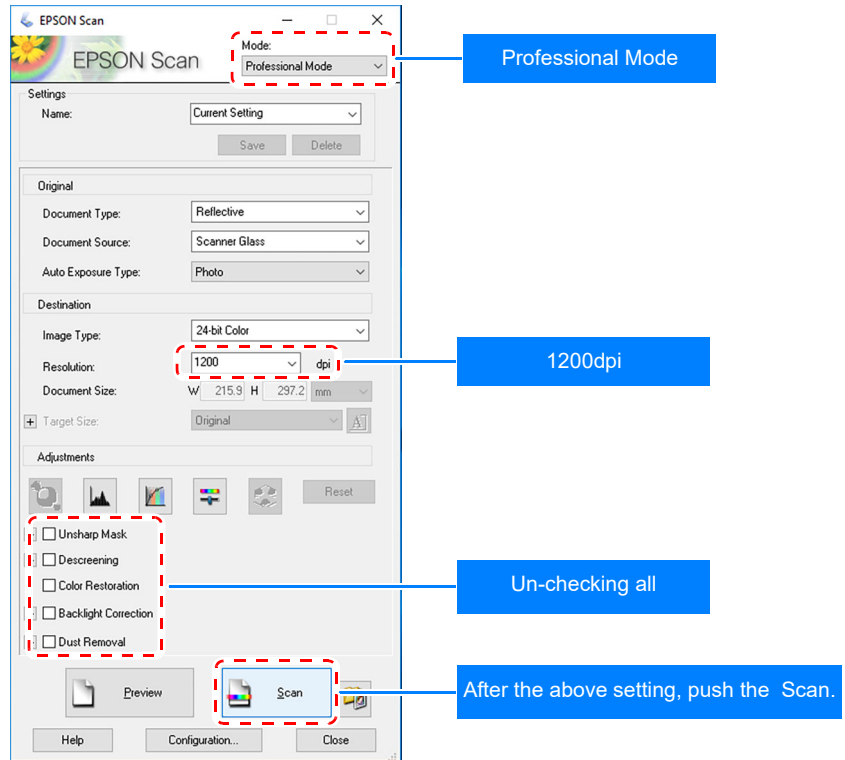

2. Read the nozzle recovery pattern Specify an arbitrary location and load the pattern.

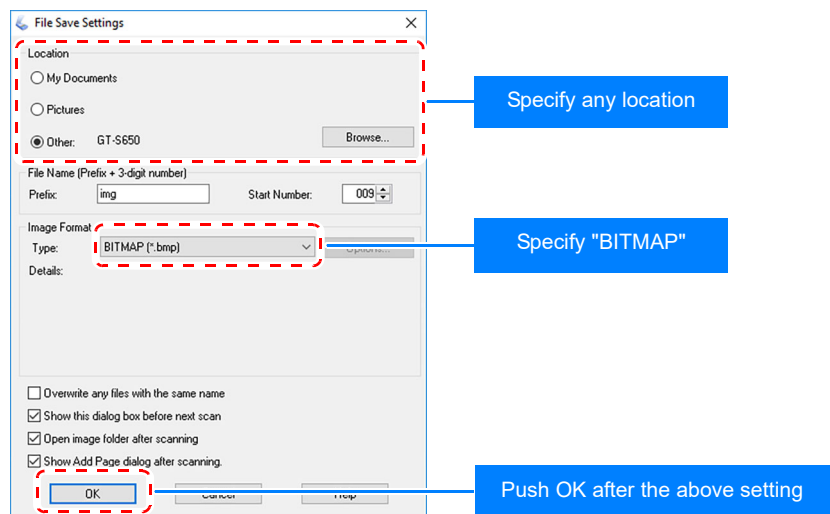

Create nozzle recovery data

Using the analysis application, analyze the scanned image and generate the nozzle recovery data.



In the analysis application, errors may be displayed for various reasons. Error indication shows only the error code and some errors do not show a message indicating the error information. Refer to the error list for the details of the error and how to handle it.

1 Start the analysis application “NZCApp”

- Start the analysis application from [SETTING] > [Nozzle recovery] > [NozzleRecoveryTool] menu.

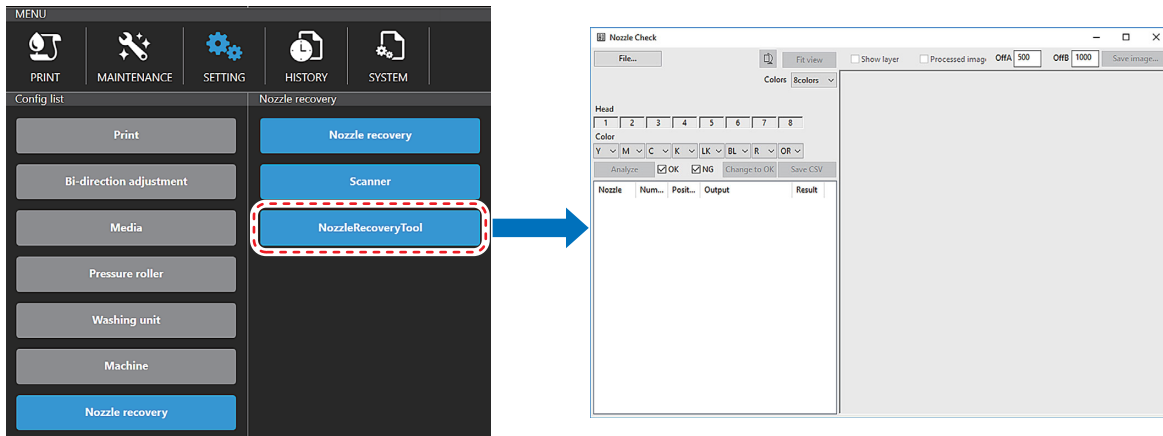

2 Analyzing patterns

- Tap the [File ...] button and select the scanned nozzle recovery pattern image data.

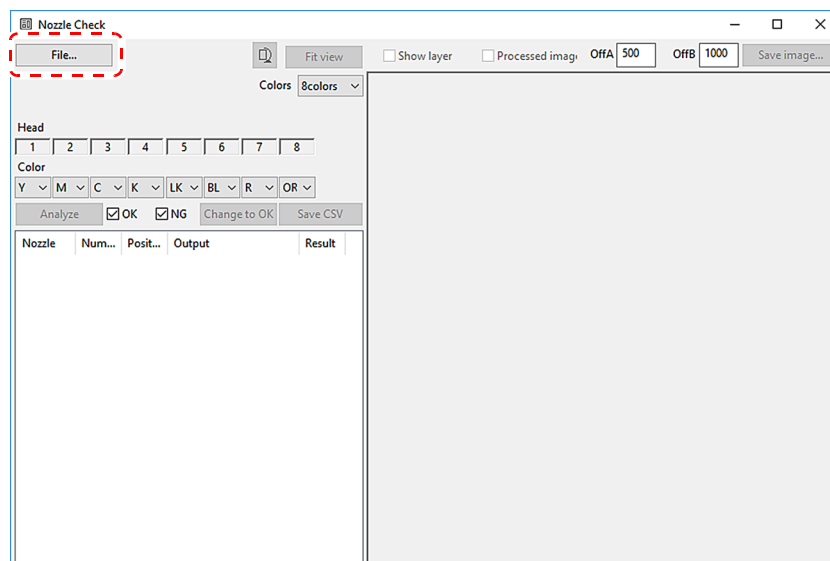

2. Check that the color order and ink set is the same as the selected image data.

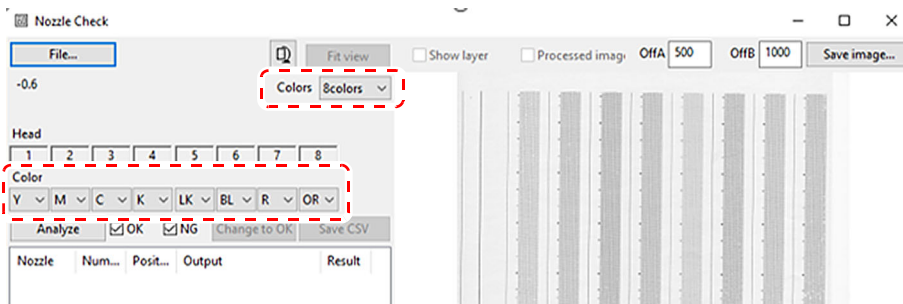

3. Tap the [Analyze] button to start the analysis.

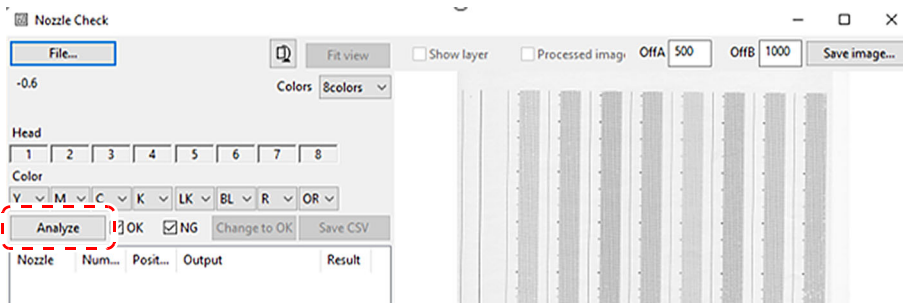

3

Confirm and modify the nozzle missing analysis results

- When analysis is completed, analysis results are displayed in the lower left.
- Check the analysis results and correct them if necessary.

Nozzle	Num...	Posit...	Output	Result
Y0001	1	10999	0,0,0,0,0,1,1,1,0,0,0,0,...	OK
Y0002	2	10997	0,0,0,0,1,1,1,0,0,0,0,0,...	OK
Y0003	3	10994	0,0,0,0,0,0,1,1,1,0,0,0,...	OK
Y0004	4	10992	0,1,1,1,1,0,0,0,0,0,0,0,...	OK
Y0005	5	10990	0,0,0,0,0,0,1,1,1,0,0,0,...	OK
Y0006	6	10988	0,0,0,0,0,0,1,1,1,0,0,0,...	OK
Y0007	7	10986	0,0,0,0,1,1,1,0,0,0,0,0,...	OK
Y0008	8	10984	0,0,0,0,0,1,1,1,0,0,0,0,...	OK
Y0009	9	10982	0,0,0,0,0,0,1,1,1,0,0,0,...	OK
Y0010	10	10980	0,0,0,0,0,1,1,1,1,0,0,0,...	OK
Y0011	11	10978	0,0,0,0,0,0,1,1,1,0,0,0,...	OK
Y0012	12	10976	0,0,0,1,1,1,1,0,0,0,0,0,...	OK
Y0013	13	10974	0,0,0,0,0,1,1,1,0,0,0,0,...	OK
Y0014	14	10972	0,0,0,0,0,1,1,1,1,0,0,0,...	OK
Y0015	15	10970	0,0,0,0,1,1,1,0,0,0,0,0,...	OK
Y0016	16	10968	0,1,1,0,0,0,0,0,0,0,0,0,...	OK
Y0017	17	10966	0,0,0,0,0,0,1,1,1,0,0,0,...	OK

1. Check the result

Select the nozzle number to check, and check the [Processed image] check box on the upper right. The image of the corresponding nozzle is displayed. Check the nozzle status.

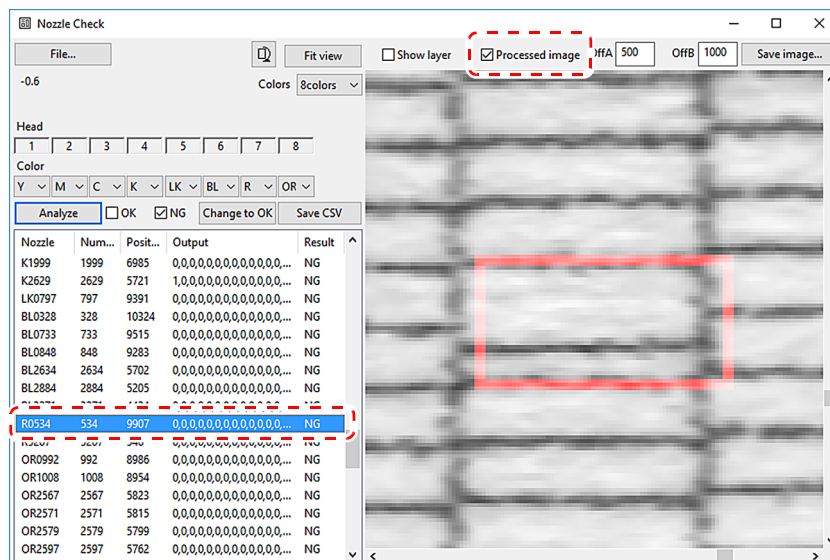

2. Modify the result

After checking the nozzle condition if the nozzle condition is no problem it is possible to change the result from "NG" to "OK".

To change to "OK", select the relevant nozzle and tap the [Change to OK] button.

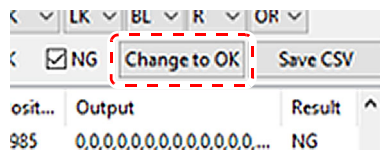

4

Creating nozzle recovery data

- After checking and correcting the analysis results, tap the [Save CSV] button to create nozzle recovery data.

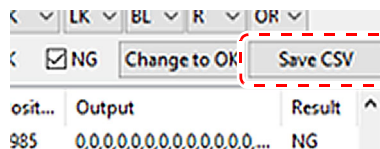

Enable the nozzle recovery function

After creating the nozzle recovery data, by enabling the nozzle recovery function, the function will be applied from the next print.

From the [SETTING] > [Nozzle Recovery] > [Nozzle Recovery] menu, open the setting screen and set "Nozzle recovery" to "ON".

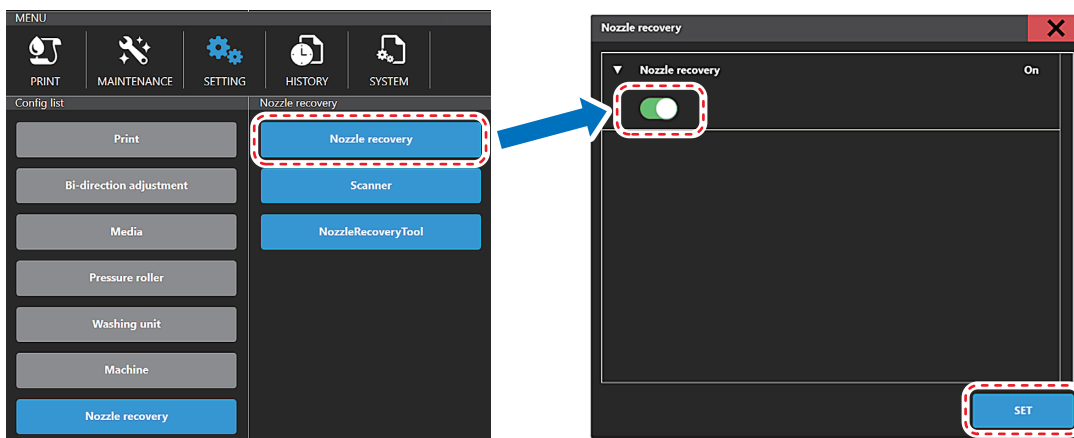

MAINTENANCE

This section describes maintenance methods such as Cleaning operation and head cleaning. Auto cleaning setting in idle or print is performed from the [SETTING] menu.

Description of maintenance content

Maintenance operations are performed from the maintenance menu.

Maintenance content screen configuration

Select and execute a maintenance item from [Maintenance list].

When selecting Maintenance list, the set values of each maintenance item are displayed in the Maintenance settings list.

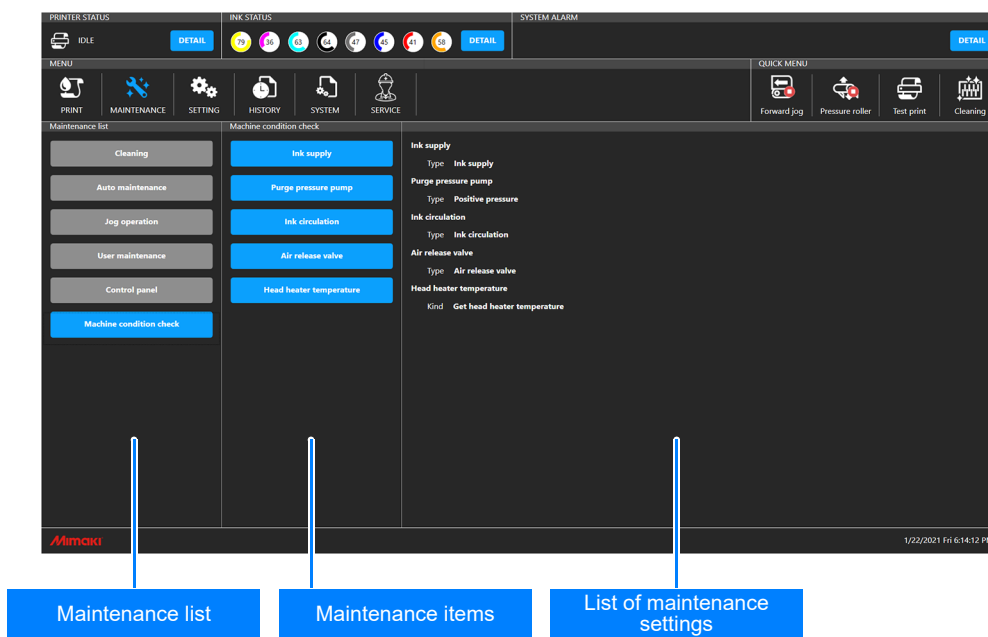

Operation of Control panel

Feed Control, Pressure roller operation, Carriage out operation, and Wiper cleaning pump operation can be performed from the MPC menu and the machine operation panel.

Display the operation panel

Select [MAINTENANCE] > [Control panel] > [Control panel] to display the [Feed Control] and [Pump Control] dialogs.

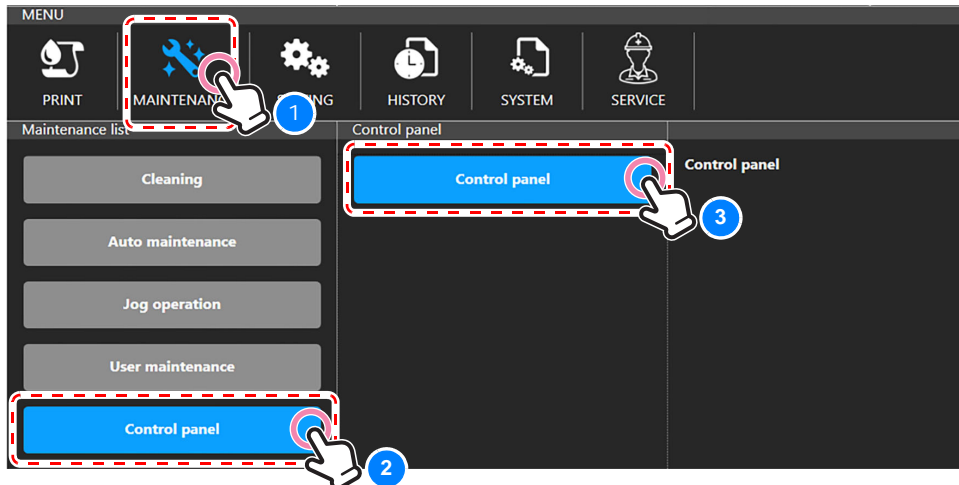

Feed operation, Pressure roller operation

On this operation screen, you can operate Forward feed, Reverse feed, Feed speed change, and Pressure roller operation. Please use it when changing the grounding agent or setting the media.

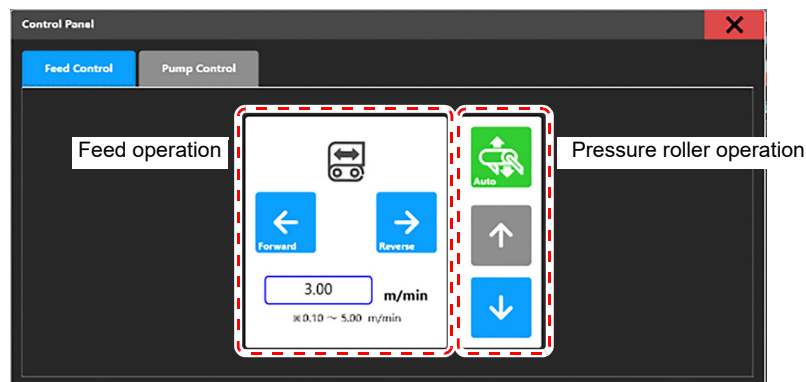

Operation of the wiper cleaning pump

On this operation screen, you can operate the carriage and set and operate the output of wiper cleaning pump. The set wiper cleaning pump output is applied to the cleaning pump output during cleaning. Please use it for the maintenance of wiper, changing the output value of the cleaning pump, and checking the output.

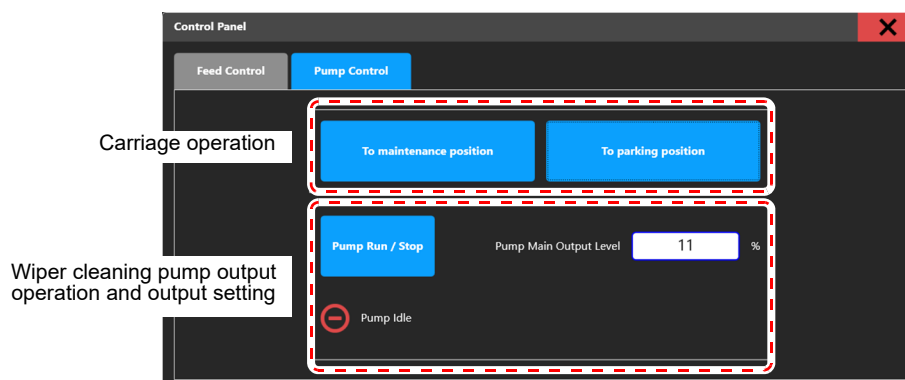

SETTING

This section explains Settings related to print quality and auto maintenance, peripheral device operating conditions and mechanical operation and others that can be set by the user.

Description of the setting content

Setting operations are performed from the SETTING MENU.

Description of the setting content screen

Select the item to be set from the [Print] item in Config list field.

When an item in the Config list field is selected, the set values of each set item are displayed in the set item content list.

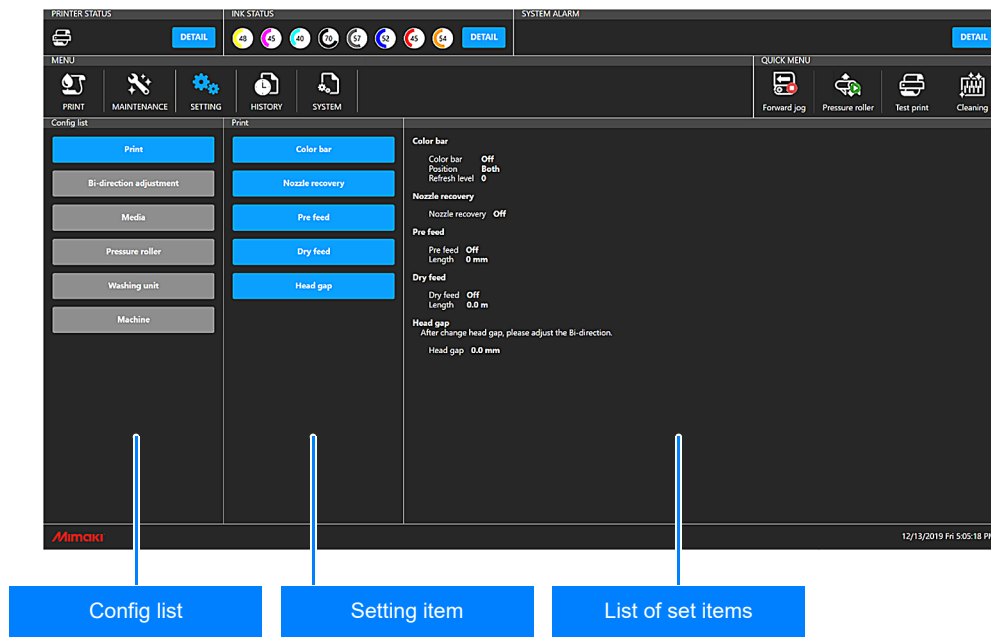

Example of setting procedure - Color bar

An example of color bar settings is shown below.

1 Select setting item.

- Select [ SETTING] MENU > [Print] > [Color bar] to display the <Color bar setting> dialog.

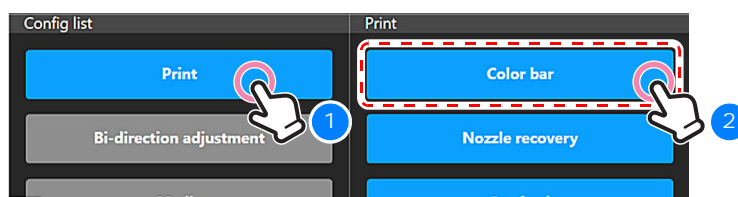

2 Enter the set value.

- Enter or select a value for each item in the Setting dialog.

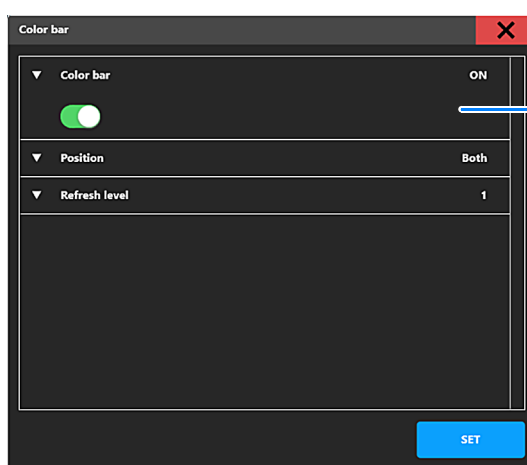

<Setting> dialog

3 Confirm the settings

- Tap the [Setting] button to confirm the settings. Close <Setting> dialog after setting is completed, and the setting is reflected in the Setting item list.

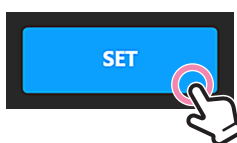

Feature description

STATUS bar

PRINTER STATUS

Shows printer status.

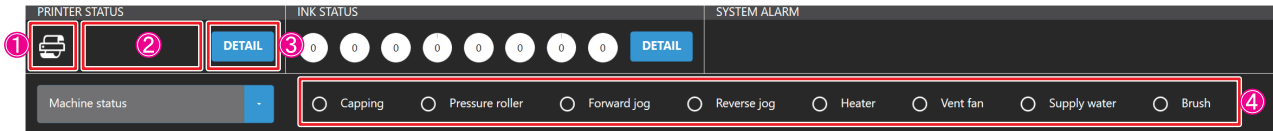

No.	Name	Icon	Description
1	Printer status icon		Initial state
			Idling
			Printing
			Paused
			Maintenance
2	Printer status explanation	-	Idling / Printing / Paused / Cleaning
3	[DETAIL] button		Tap to display the machine status.
4	Display the machine status		Displays the status of Capping / Pressure roller / Forward jog / Reverse jog / Heater / Vent fan / Supply water / Brush.

INK STATUS

Displays ink color and ink remaining for each ink slot in graph and percentage (%). When the ink level is low, an icon is displayed at the bottom right of each ink.

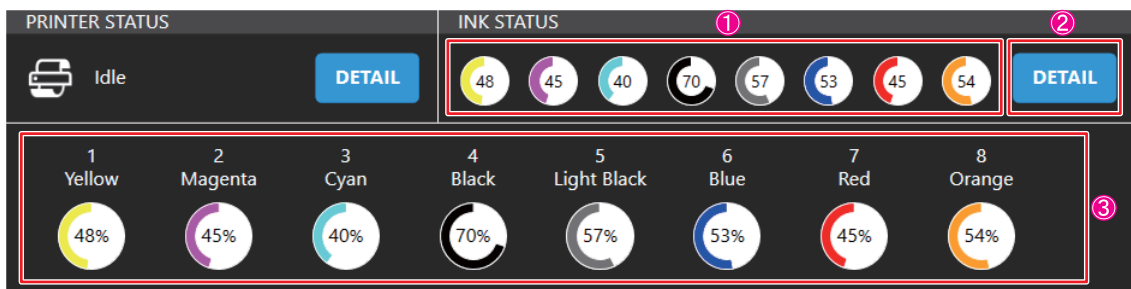

No.	Name	Icon	Description
1	INK STATUS		Normal display (Remaining ink level: 26% ~ 100%)
			: Display icon at the bottom right Ink near end (Remaining ink level: 21% ~ 25%)
			: Display icon at the bottom right Ink end (Remaining ink level: 0% ~ 20%)
2	[DETAIL] button		Tap to display information for each ink.
3	Detailed ink information display		For each ink, the No., color name and remaining ink are displayed.

SYSTEM ALARM

Alarm information is displayed when an error occurs in the machine.

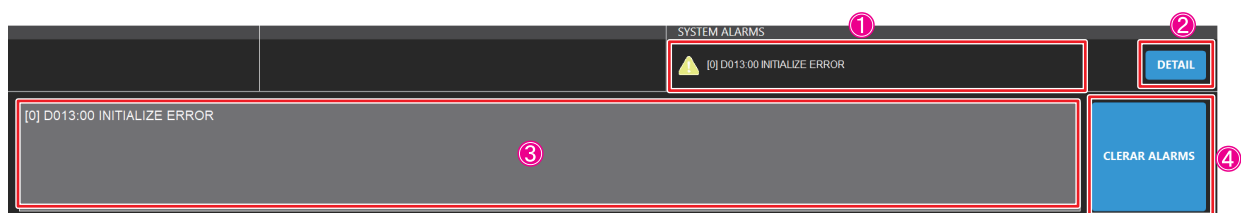



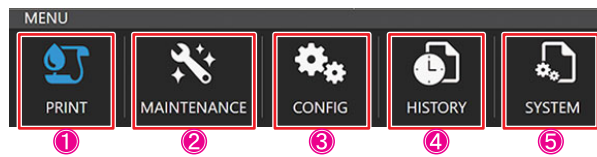

The details of alarms are described on [\[SYSTEM ALARM \(P.6-21\)\]](#).

MENU

Menus are organized by function, and the function items of the selected menu are displayed in the content area.



No.	Name	Icon	Description	Reference
1	[PRINT] MENU		Perform the job management and print operations.	P.6-46
2	[MAINTENANCE] MENU		Perform printer maintenance. Perform operations related to each maintenance.	P.6-51
3	[SETTING] MENU		Make various printer settings.	P.6-55
4	[HISTORY] MENU		Display the history of each operation.	P.6-61
5	[SYSTEM] MENU		Displays the system information and system configuration.	P.6-62

Menu configuration list

MENU			Reference
PRINT			P.6-46
MAINTENANCE	[Cleaning]	Cleaning	P.6-51
		Powerful cleaning	
	[Auto maintenance]	Cleaning (Idle)	P.6-52
		Cleaning (Print)	
	[Jog operation]	Forward jog	P.6-53
		Reverse jog	
		Jog speed	
	[User maintenance]	Carriage operation	P.6-53
		Maintenance wizard	
	[Control panel]	Control panel	P.6-54
	[Machine condition check]	Ink supply	P.6-54
		Purge pressure pump	
Ink circulation			
Air release valve			
[Print]	Color bar	P.6-55	
	Pre feed		
	Dry feed		
	Head gap		
	Head heater temperature		
[Bi-direction adjustment]	Bi-direction adjustment	P.6-56	
	└ 600Std pattern		
	└ 600Hi pattern		
	└ 1200Hi pattern		
[Media]	Media setting	P.6-57	

MENU		Reference	
SETTING	[Pressure roller]	Auto setting	P.6-57
		Pressure roller	
	[Washing unit]	Auto setting	P.6-58
		Washing tank	
		Washing brush	
		Wash water supply	
	[Machine]	Obstacle sensor	P.6-59
		Winder-Unwinder	
		Belt heater	
		Vent fan	
		Light On/Off	
	[Nozzle recovery]	Nozzle recovery	P.6-60
		Scanner	
NozzleRecoveryTool			
HISTORY	Print	P.6-61	
	Maintenance		
	Alarm		
	Controller		
	Parts		
	Condition		
SYSTEM	[System config]	Language	P.6-62
	[Information]	HDD Capacity	P.6-62
		Version	
		License	
		Log collection tool	
	[Document]	Operation guide	P.6-63
		Alarm list	
	[Maintenance mode]	Maintenance mode	P.6-63
	[Power]	System reconfiguration	P.6-64
		Reset machine	
Reboot PC			
Shutdown PC			







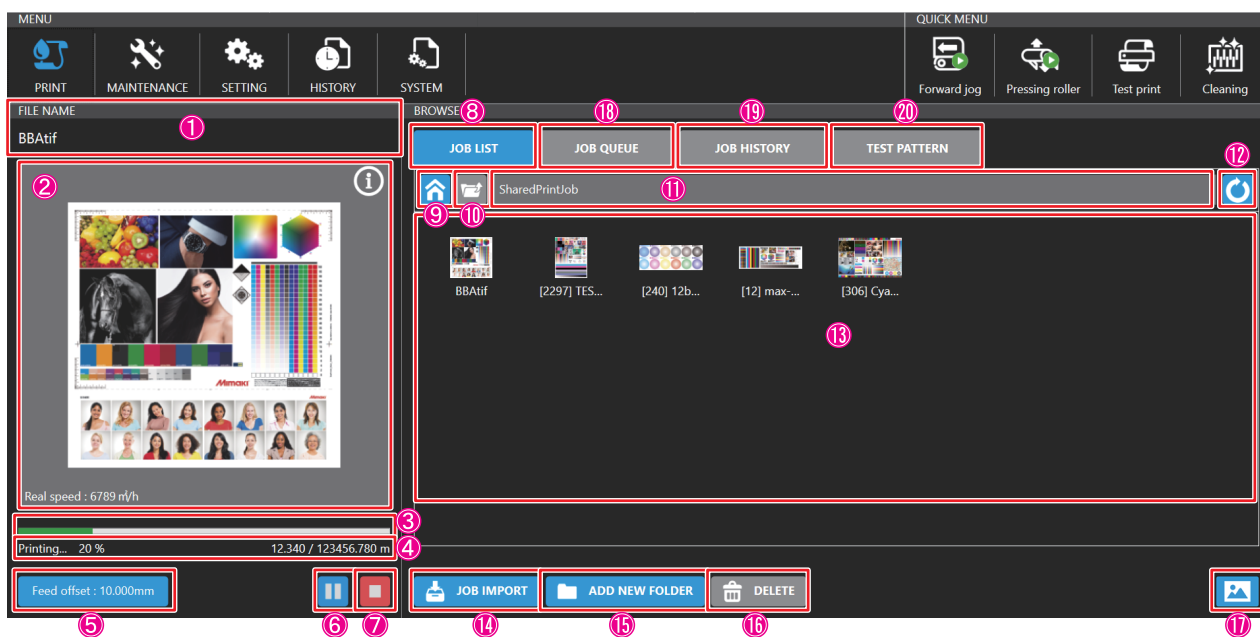

[PRINT] MENU

Perform the job management and printing operations.

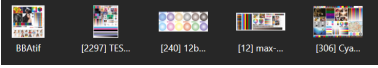
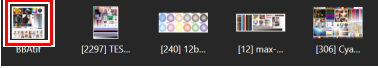
[JOB LIST] tab

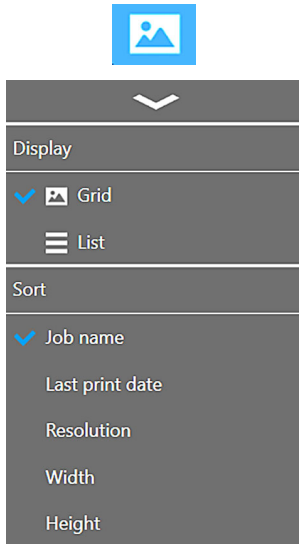
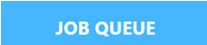

No.	Name	Icon	Description
1	Job name display		Displays the name of the job being printed.
2	Job thumbnail display		Displays the job thumbnail.
3	Print progress display		Displays the print progress.
4	Print status display		Shows print status. <ul style="list-style-type: none"> • Stopping • Preparing to print ... • Printing ... • Pausing
5	Feed offset value		<Feed offset setting> dialog is displayed.
6	Pause printing		Pauses printing.
	Resume printing		Resume printing.
7	Cancel printing		Cancel printing.
8	JOB LIST tab		Shows Job list.
9	To the home folder		Shows the home folder.

No.	Name	Icon	Description
10	Go up one folder level		Displays the folder one level above.
11	Current folder name display		Tap to display the name of the folder that is currently open.
12	Update folder		The currently folder is updated.
13	Job thumbnail display		Data in the currently folder is displayed as a thumbnail.
	Job selection		Tap the job to display the <Print condition selection> dialog.
14	Job import		The <JOB IMPORT> dialog is displayed.
15	Add new folder		The <ADD NEW FOLDER> dialog is displayed.
16	Deleting a job		Press and hold the job you want to delete and tap [DELETE] to delete the job.
17	Display, sort menu		<p>Tap the icon to display the [Display] menu and the [Sort] menu.</p> <ul style="list-style-type: none"> • [Display] menu <ol style="list-style-type: none"> (1) Grid : Simple thumbnail display (2) List : Detailed list display • [Sort] menu <ol style="list-style-type: none"> (1) Job name (2) Last print date (3) Resolution (4) Width (5) Height
18	JOB QUEUE tab		Displays a list of jobs waiting to be printed. [JOB QUEUE] tab (P.6-48)
19	JOB HISTORY tab		Displays a list of printed jobs. [JOB HISTORY] tab (P.6-49)
20	TEST PATTERN tab		Displays a list of jobs for the test pattern. [TEST PATTERN] tab (P.6-50)

[JOB QUEUE] tab

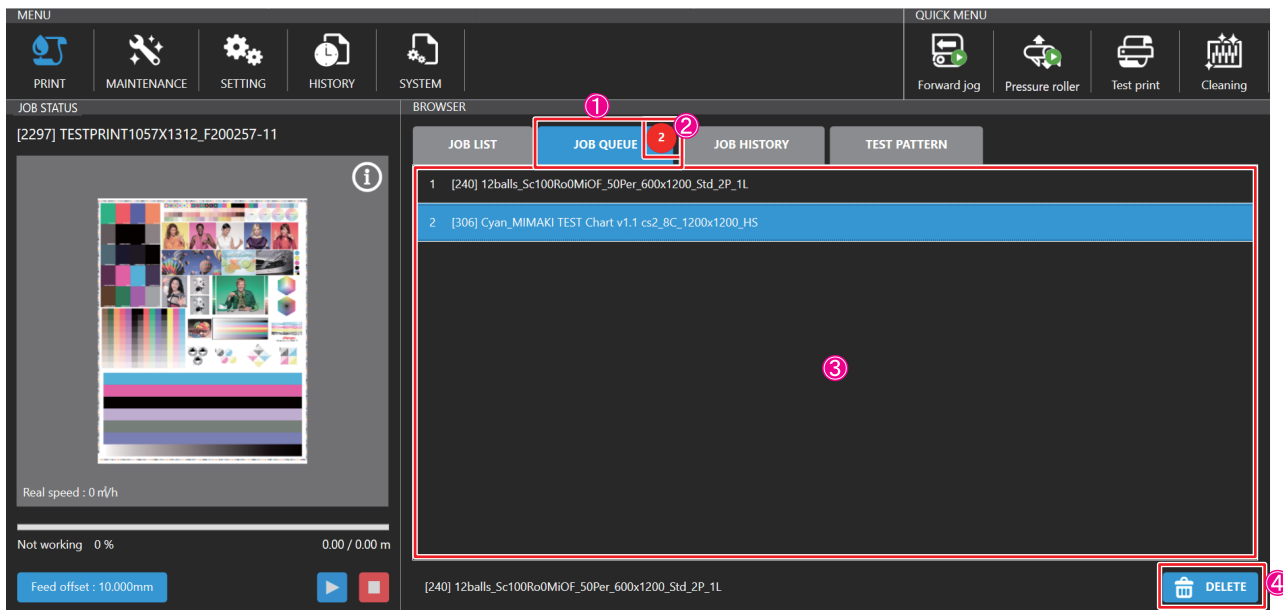

No.	Name	Icon	Description
1	JOB QUEUE tab		Displays a list of jobs waiting to be printed.
2	Number of waiting jobs		The number of jobs waiting to be printed is displayed.
3	Queuing job selection		When you tap a job, the <Print Condition> dialog is displayed and you can change the print condition.
4	Deleting a job		Press and hold the job you want to delete and tap [DELETE] to delete the job.

[JOB HISTORY] tab

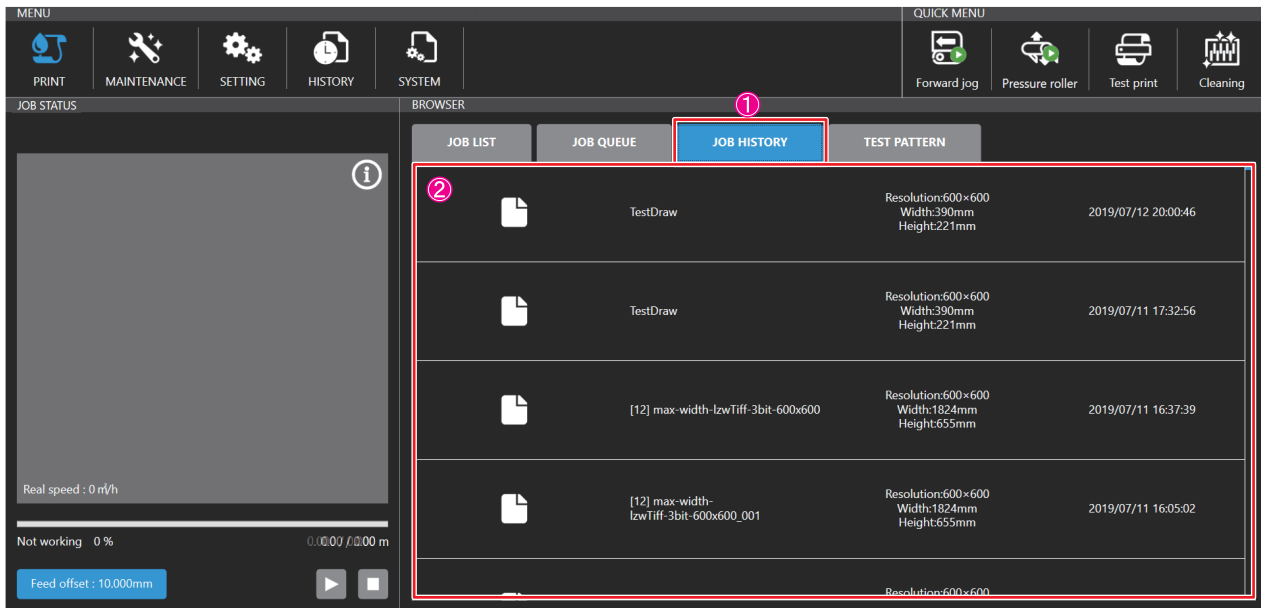

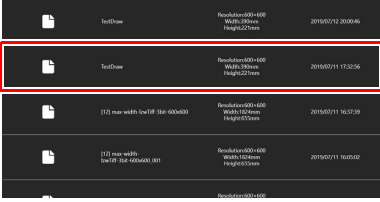
No.	Name	Icon	Description
1	JOB HISTORY tab		Displays a list of printed jobs.
2	Job selection		Tap the job to display the <Print condition selection> dialog and you can reprint.

[TEST PATTERN] tab

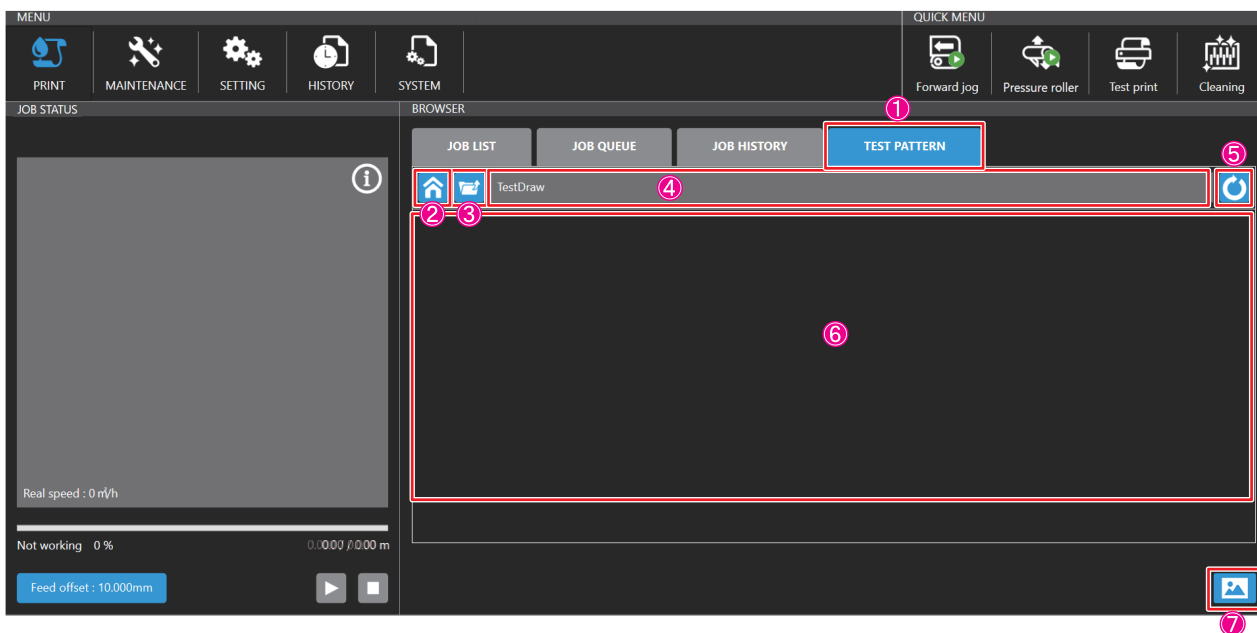

No.	Name	Icon	Description
1	TEST PATTERN tab		Displays a list of jobs for the test pattern.
2	To the home folder		Shows the home folder.
3	Go up one folder level		Displays the folder one level above.
4	Current folder name display		Tap to display the name of the folder that is currently open.
5	Update folder		The currently folder is updated.
6	Job thumbnail display		Data in the currently folder is displayed as a thumbnail.
7	Display, sort menu		<p>Tap the icon to display the [Display] menu and the [Sort] menu.</p> <ul style="list-style-type: none"> • [Display] menu <ul style="list-style-type: none"> (1) Grid : Simple thumbnail display (2) List : Detailed list display • [Sort] menu <ul style="list-style-type: none"> (1) Job name (2) Last print date (3) Resolution (4) Width (5) Height

[MAINTENANCE] MENU

Perform maintenance and maintenance settings.

[Cleaning]

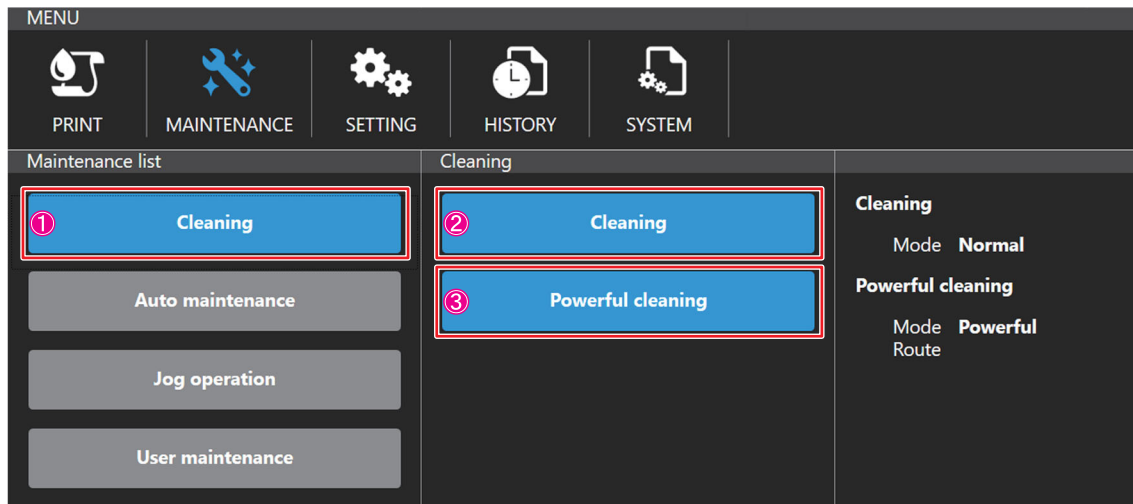

No.	Name	Description	Initial value:	Recommended value:
1	Cleaning	The [Cleaning] and [Powerful cleaning] menus are displayed.	–	–
2	Cleaning	Select the Cleaning Mode (Soft / Normal / Hard) and perform.	Normal	Normal
3	Powerful cleaning	Perform powerful cleaning.	–	–

[Auto maintenance]

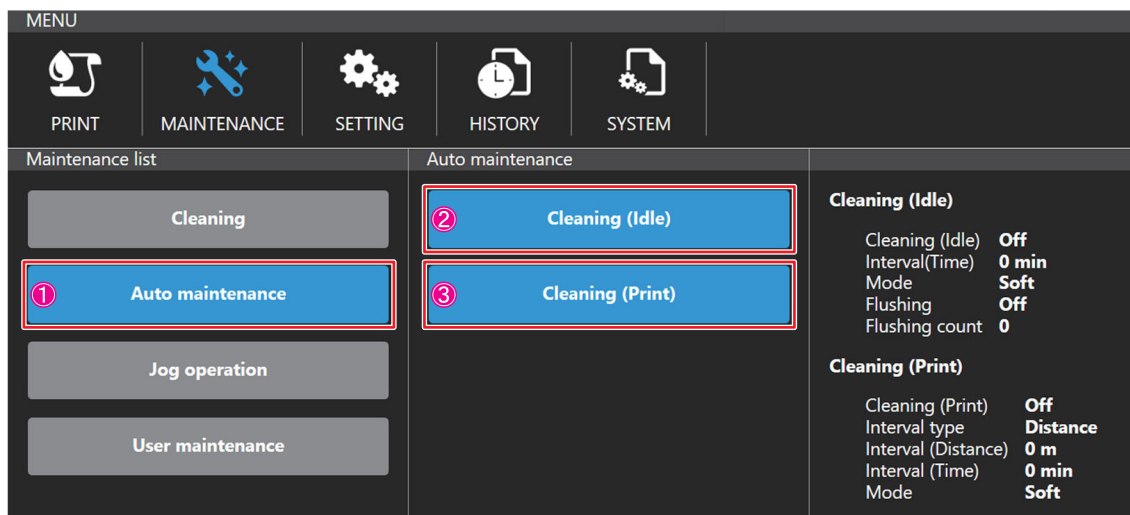

No.	Name	Description	Initial value:	Recommended value:
1	Auto maintenance	The [Cleaning (Idle)] and [Cleaning (Print)] menus are displayed.	–	–
2	Cleaning (Idle)	The following items can be set.	–	–
		• Idle cleaning On / Off	On	On
		• Execution interval (hours)	30	30
		• Mode (Soft / Normal / Hard)	Normal	Normal
		• Flushing On / Off	On	On
3	Cleaning (Print)	• Number of flushes	3	3
		The following items can be set.	–	–
		• Cleaning in print On / Off	On	On
		• Interval type: Distance/Time	Hour	Hour
		• Interval (Distance)	100	100
• Interval (Time)	30	30		
• Mode (Soft / Normal / Hard)	Normal	Normal		

[Jog operation]

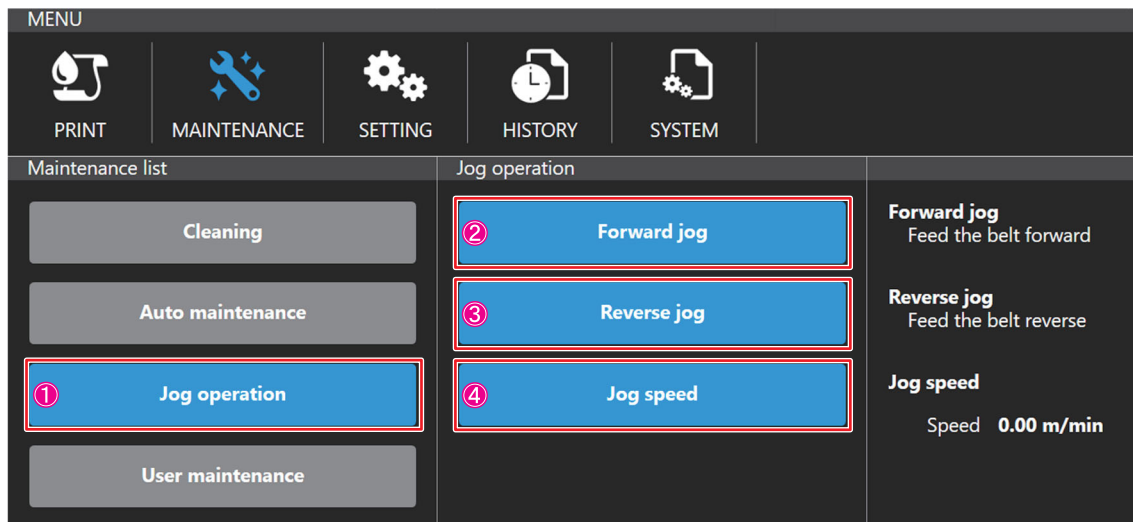

No.	Name	Description	Initial value:	Recommended value:
1	Jog operation	The [Forward jog], [Reverse jog], [Jog speed] menu will be displayed.	-	-
2	Forward jog	Operate Forward jog with [Start], [Stop] buttons.	-	-
3	Reverse jog	Operate Reverse jog with [Start], [Stop] buttons.	-	-
4	Jog speed	Set the feed speed (0.01 to 5.00 m / min).	2.0	2.0

[User maintenance]

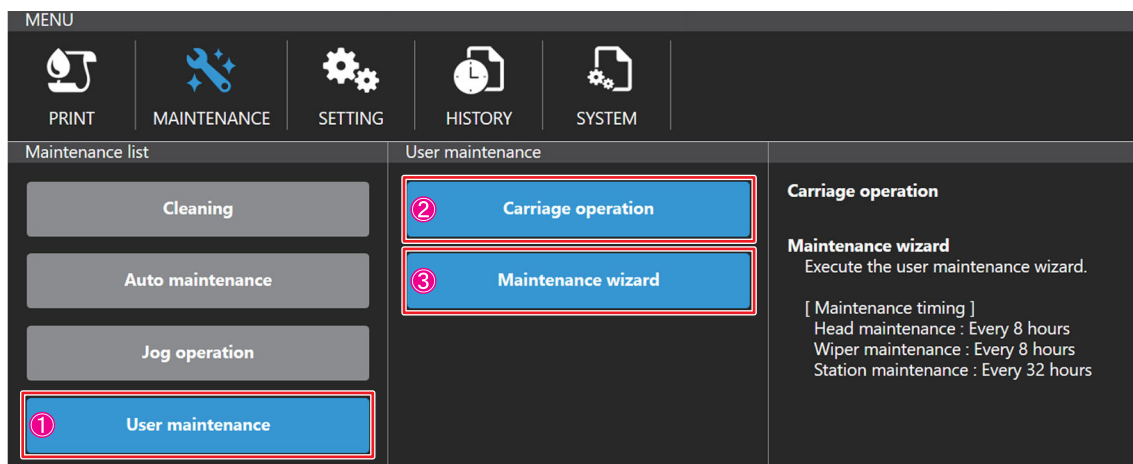

No.	Name	Description
1	User maintenance	The [Carriage operation] and [Maintenance wizard] menus are displayed.
2	Carriage operation	Move the carriage to [Maintenance position] or [Parking position].
3	Maintenance wizard	Follow the instructions on the screen to perform head maintenance, wiper maintenance, and station maintenance.

[Control panel]

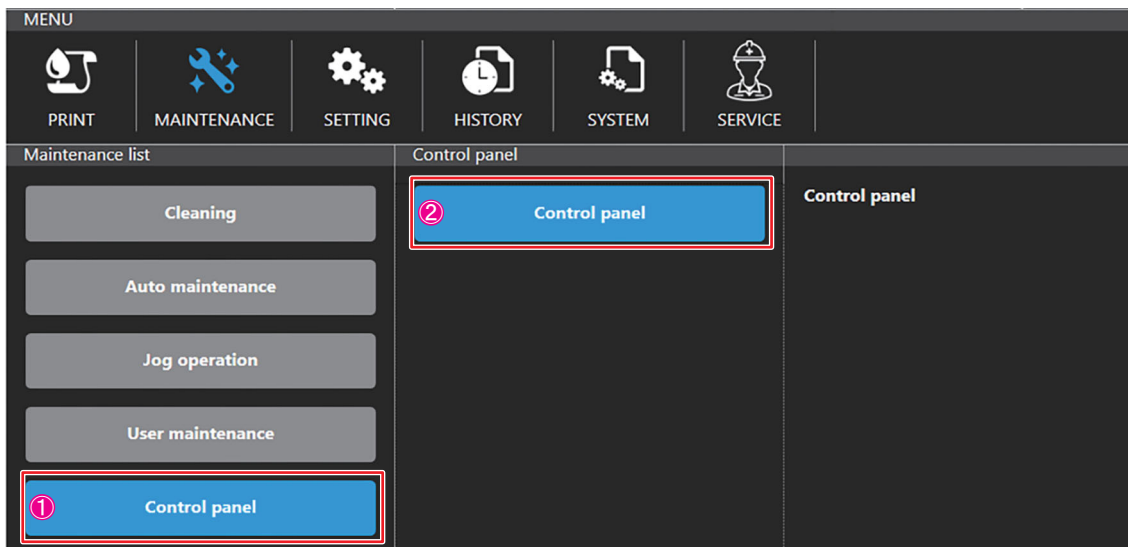

No.	Name	Description
1	Control panel	The operation panel window is displayed.
2	Control panel	Feed operation, Pressure roller operation, Carriage out operation, and Wiper cleaning pump operation can be performed.

[Machine condition check]

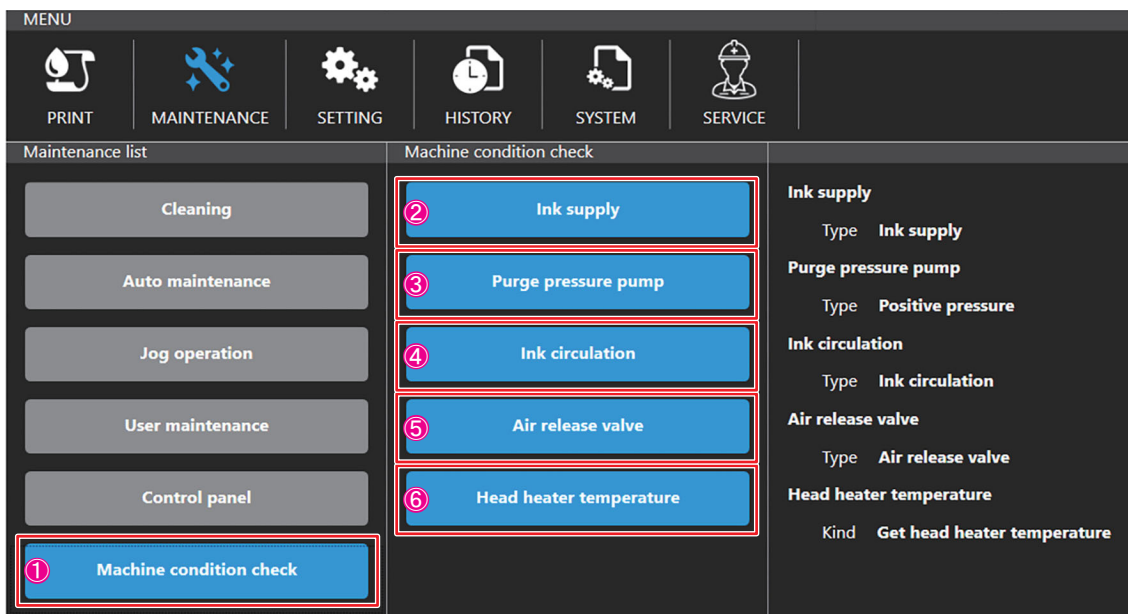

No.	Name	Description
1	Machine condition check	A status confirmation window will be displayed.
2	Ink supply	Executes the ink supply check operation and displays the execution time.*1
3	Purge pressure pump	Executes the positive pressure generation check operation and displays the execution time.*1
4	Ink circulation	Executes the ink circulation check operation and displays the execution time.*1
5	Air release valve	Executes the air release valve check operation and displays the execution time.*1
6	Head heater temperature	The head temperature is displayed.

*1 To protect the nozzle surface, it consumes the equivalent amount of ink to be used during the soft cleaning.

[SETTING] MENU

Make various settings.

[Print]

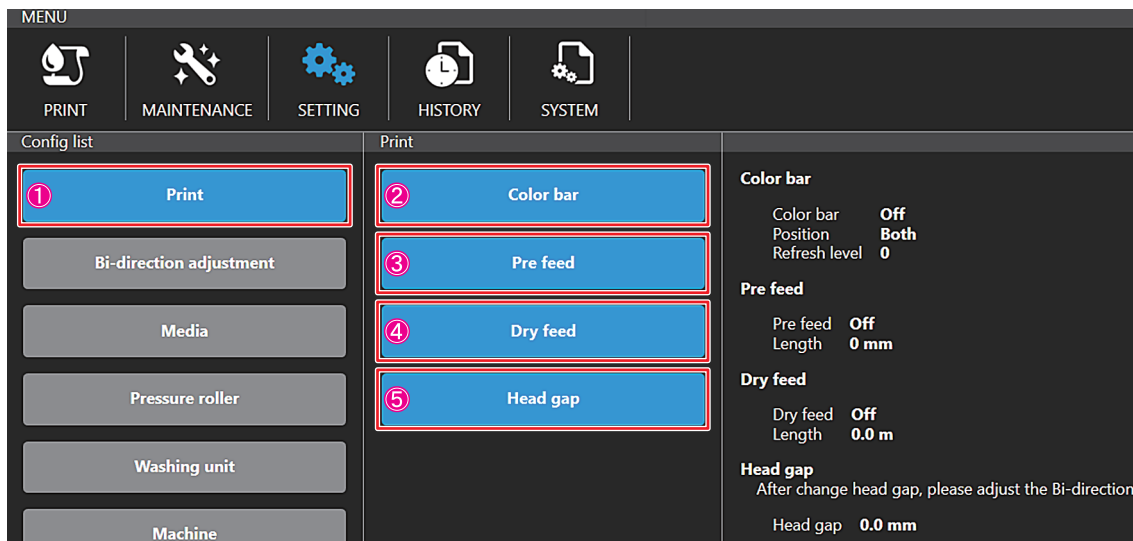

No.	Name	Description	Initial value:	Recommended value:
1	Print	The [Color bar], [Pre feed], [Dry feed], and [Head gap] menus are displayed.	-	-
2	Color bar	The following items can be set.	-	-
		• Color bar On / Off	On	On
		• Color bar position (both ends / left)	Both	Both
3	Pre feed	The following items can be set.	-	-
		• Pre feed on / off	On	On
		• Pre feed length (1 to 1000mm)	5.0	5.0
4	Dry feed	The following items can be set.	-	-
		• Dry feed on / off	Off	Off
		• Length of dry feed (0.1-10.0m)	0.1	0.1
5	Head gap	Set the head gap (0.0 to 15.0mm).	1.5	1.5

[Bi-direction adjustment]

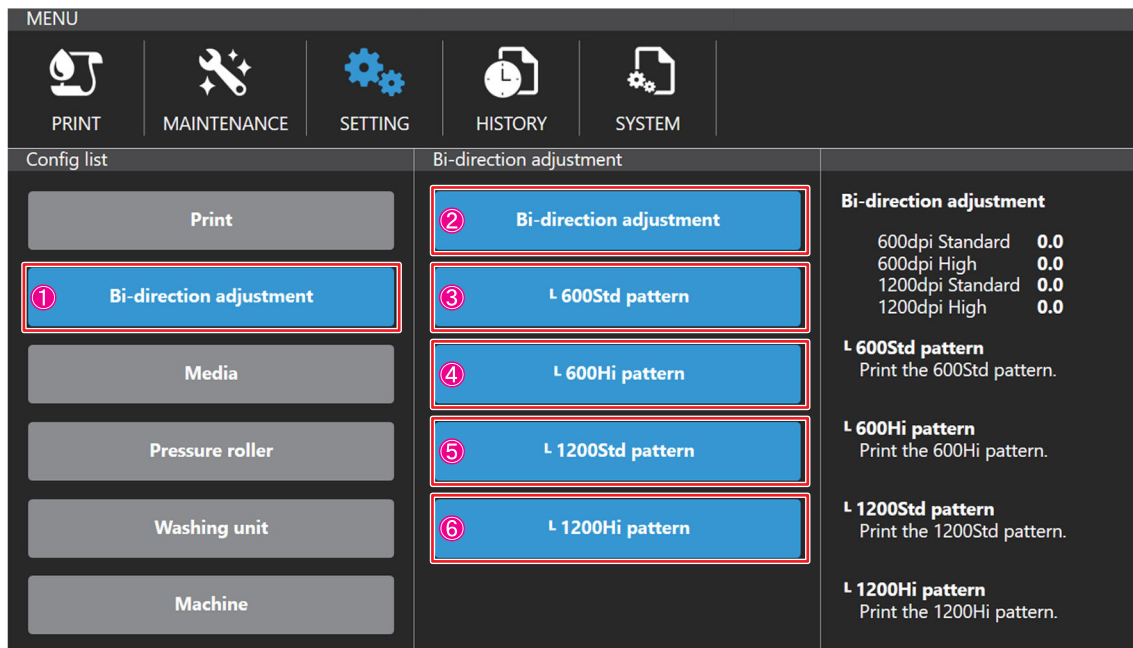

No.	Name	Description	Initial value:	Recommended value:
1	Bi-direction adjustment	The [Bi-direction adjustment], [L 600Std pattern], [L 600Hi pattern], [L 1200Std pattern], and [L 1200Hi pattern] menus are displayed.	–	–
2	Bi-direction adjustment	The following items can be set.	–	–
		• 600dpi Standard: -40.0 to 40.0	0.0	–
		• 600dpi High: -40.0 to 40.0	0.0	–
		• 1200dpi Standard: -40.0 to 40.0	0.0	–
3	L 600Std pattern	• 1200dpi High: -40.0 to 40.0	0.0	–
		L Print the 600Std pattern.	–	–
4	L 600Hi pattern	L Print the 600Hi pattern.	–	–
5	L 1200Std pattern	L Print the 1200Std pattern.	–	–
6	L 1200Hi pattern	L Print the 1200Hi pattern.	–	–

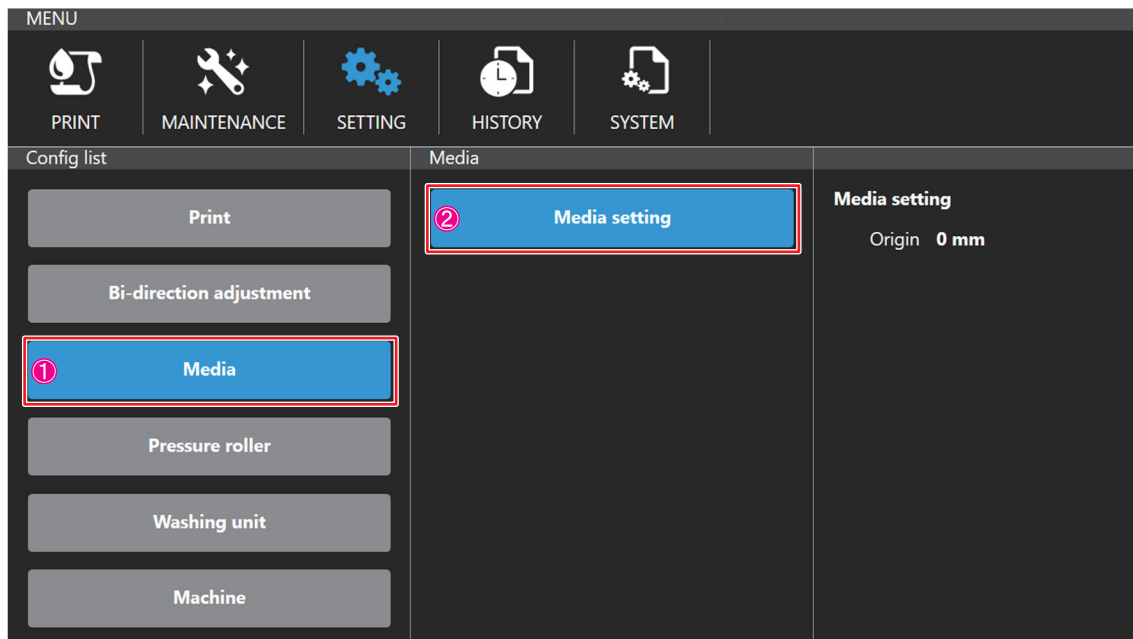
[Media]

No.	Name	Description	Initial value:	Recommended value:
1	Media	The [Media setting] menu is displayed.	–	–
2	Media setting	Set the origin (500 to 1950mm).	500	–

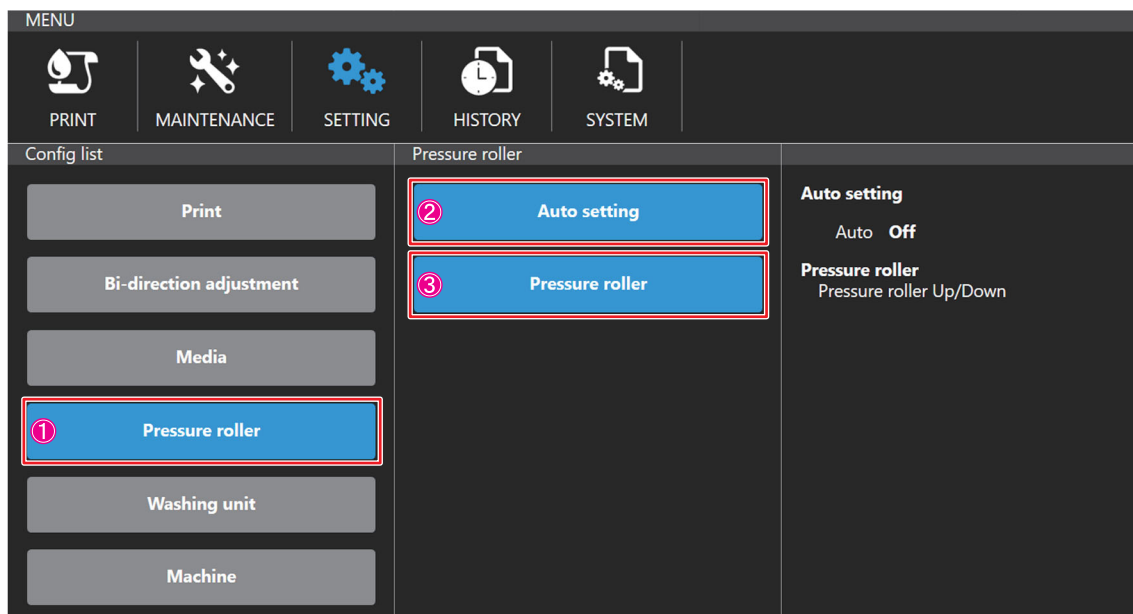
[Pressure roller]

No.	Name	Description	Initial value:	Recommended value:
1	Pressure roller	The [Auto setting] and [Pressure roller] menus are displayed.	–	–
2	Auto setting	Set On / Off.	Off	Off
3	Pressure roller	Tap the [Up / Down] button to move the pressure roller up and down.	–	–

[Washing unit]

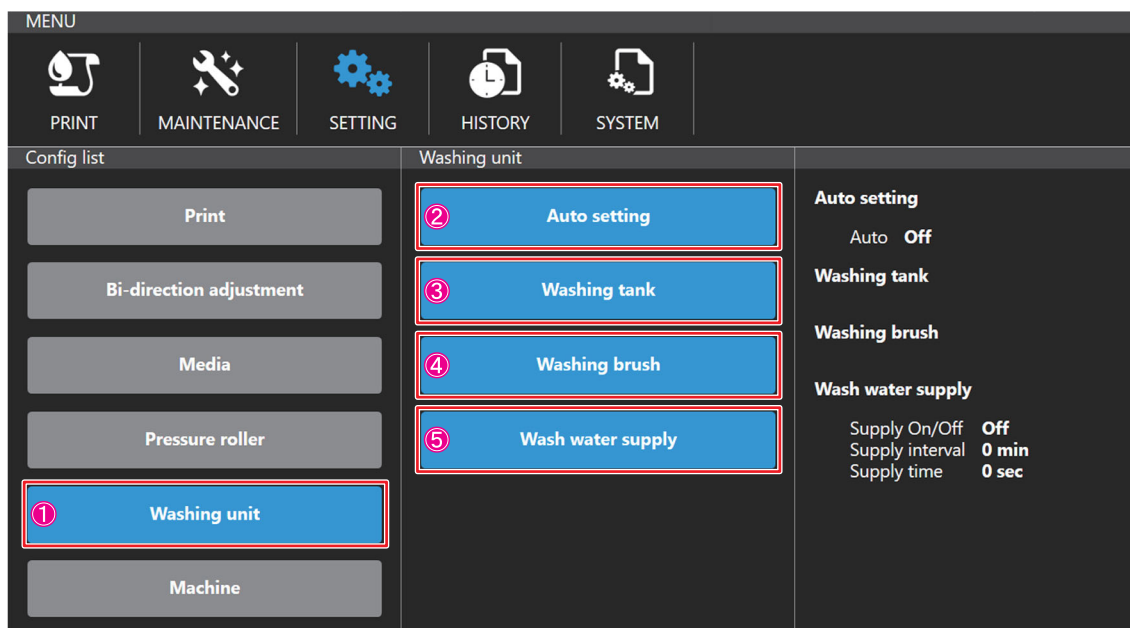

No.	Name	Description	Initial value:	Recommended value:
1	Washing unit	The [Auto setting], [Washing tank], [Washing brush], and [Wash water supply] menus are displayed.	-	-
2	Auto setting	Set On / Off.	On	On
3	Washing tank	Tap the [Operate] or [Stop] button to control the washing tank.	-	-
4	Washing brush	Tap the [Operate] or [Stop] button to control the washing brush.	-	-
5	Wash water supply	The following items can be set.	-	-
		• Supply On / Off	On	On
		• Supply interval (1-60 min)	30	30
		• Supply time (1-50 sec)	5	5

[Machine]

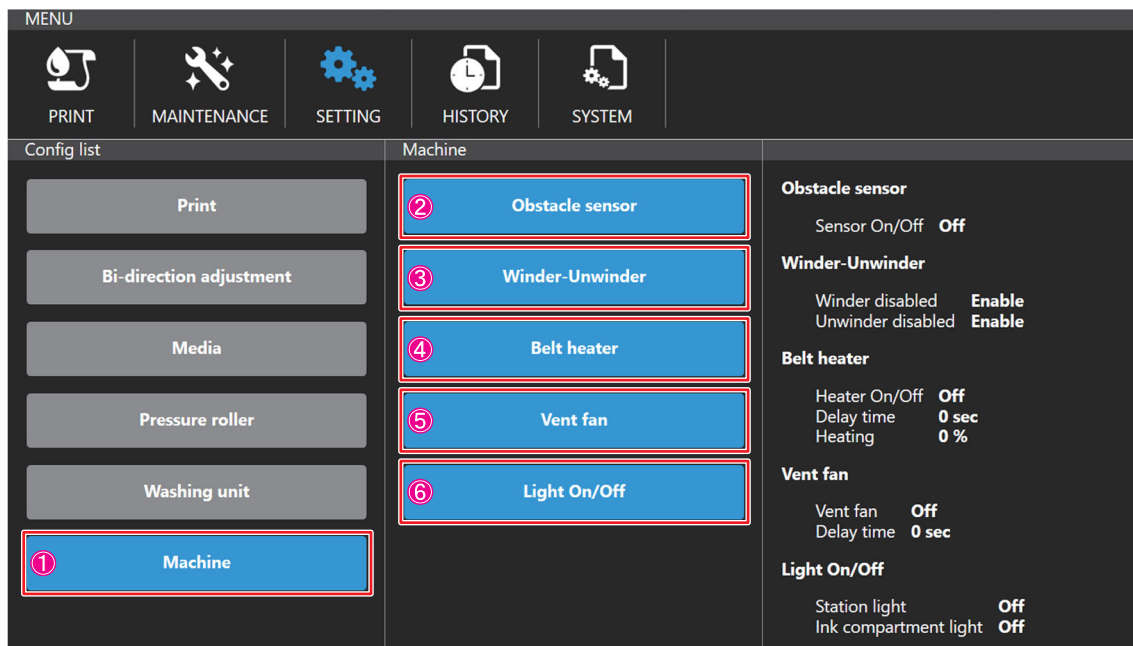

No.	Name	Description	Initial value:	Recommended value:
1	Machine	The [Obstacle sensor], [Winder-Unwinder], [Belt heater], [Vent fan], and [Light On/Off] menus are displayed.	-	-
2	Obstacle sensor	Set the obstacle sensor On / Off.	On	On
3	Winder-Unwinder	Set whether to enable / disable the winder/unwinder.	-	-
		Enable / disable of [Winder disabled]	Enable	Enable
		Enable / disable of [Unwinder disabled]	Enable	Enable
4	Belt heater	The following items can be set.	-	-
		• Heater On/Off	On	On
		• Delay time (1-5 sec)	5	5
		• Heating (0 to 100%)	60	60
5	Vent fan	The following items can be set.	-	-
		• Vent fan On / Off	On	On
		• Delay time (1-60 sec)	5	5
6	Light On/Off	The following items can be set.	-	-
		• Station light on / off	Off	Off
		• Ink compartment light	Off	Off

[Nozzle recovery]

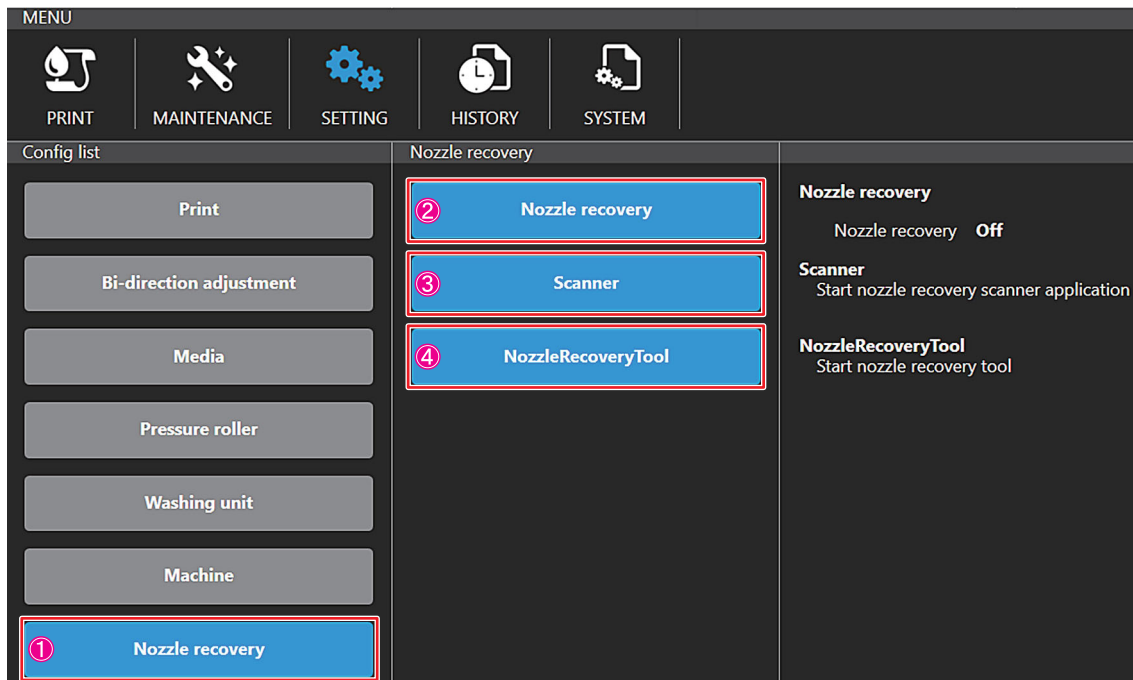

No.	Name	Description	Initial value:	Recommended value:
1	Nozzle recovery	The [Nozzle recovery], [Scanner], and [NozzleRecoveryTool] menus are displayed.	-	-
2	Nozzle recovery	Set nozzle recovery function On / Off.	Off	Off
3	Scanner	Start the scanner software to read the nozzle recovery pattern.	-	-
4	NozzleRecoveryTool	Start the tool to check the pattern read by the scanner.	-	-

[HISTORY] MENU

Perform maintenance and maintenance settings.

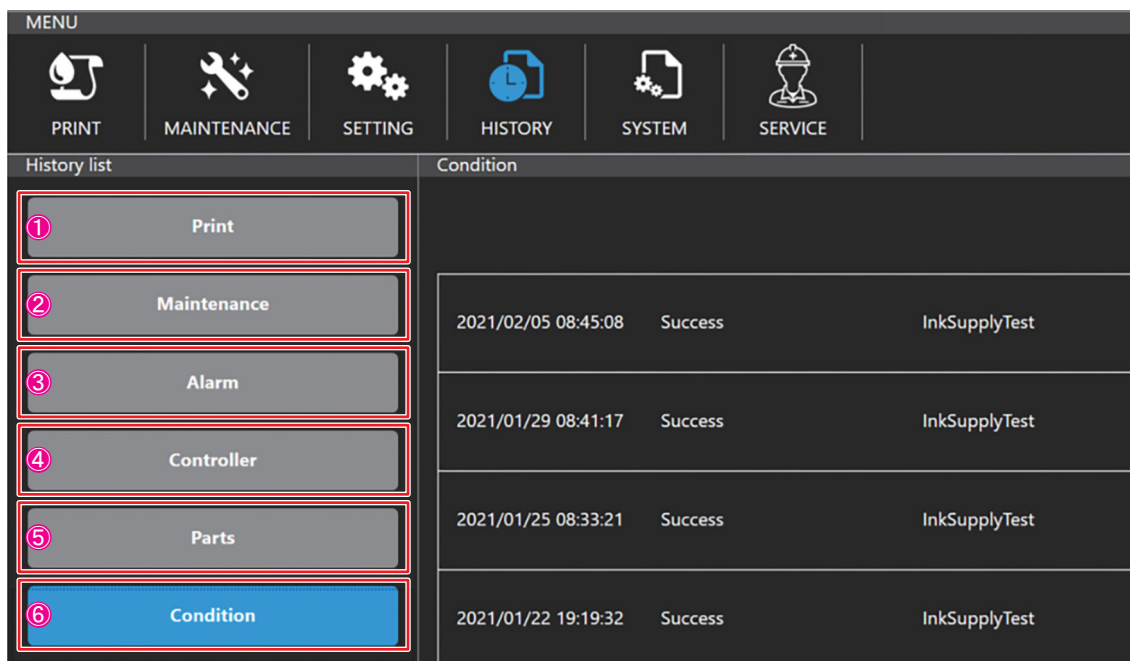

No.	Name	Description
1	Print	The print job history is displayed.
2	Maintenance	The maintenance history is displayed.
3	Alarm	The alarm history is displayed.
4	Controller	The operation history is displayed.
5	Parts	Mainly, the history of the attached head is displayed.
6	Condition	The results of Ink supply, Purge pressure pump, Ink circulation, Air release valve, and Head heater temperature executed from the condition menu are displayed in the history.

[SYSTEM] MENU

Perform maintenance and maintenance settings.

[System config]

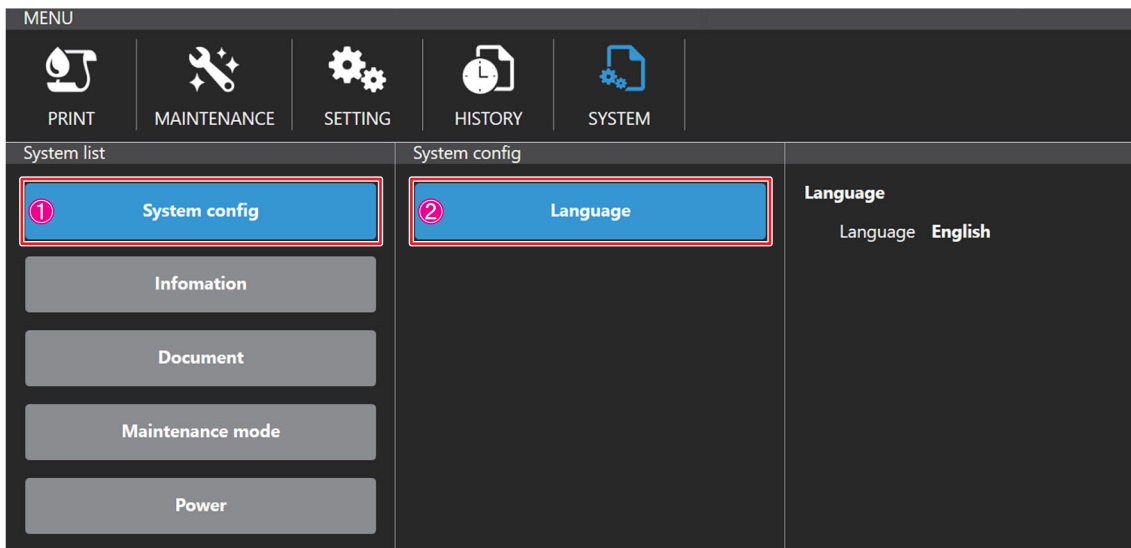

No.	Name	Description	Initial value:	Recommended value:
1	System config	The [Language] menu is displayed.	–	–
2	Language	Set the language (English / Japanese).	English	–

[Information]

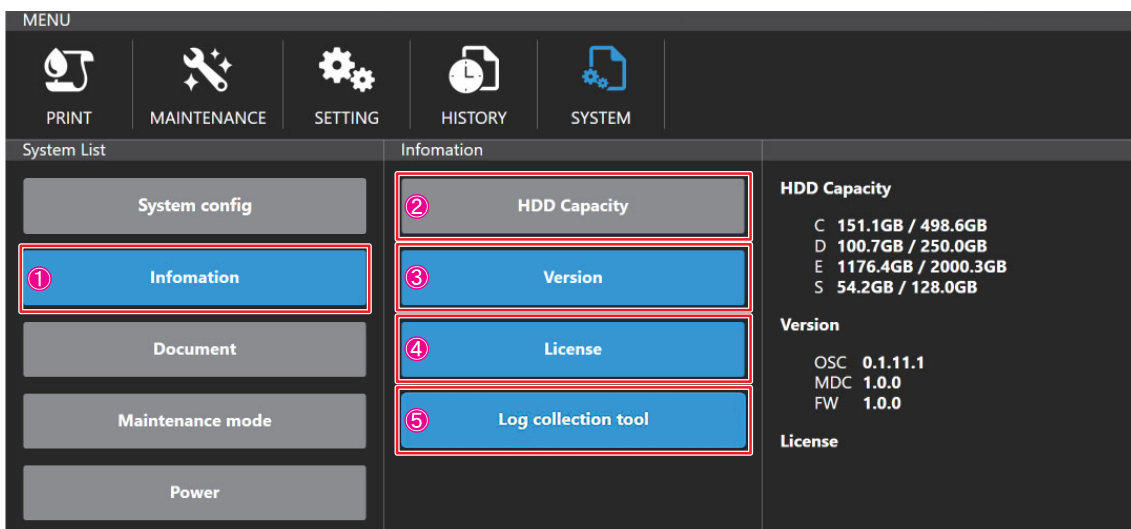

No.	Name	Description
1	Information	The [HDD Capacity], [Version], [License], and [Log collection tool] menus are displayed.
2	HDD Capacity	The disk capacity is displayed.
3	Version	MPC (this software) Version, MDC Version, and FW Version are displayed.
4	License	The license is displayed.
5	Log collection tool	The log data saved inside can be compressed and copied to a USB memory.

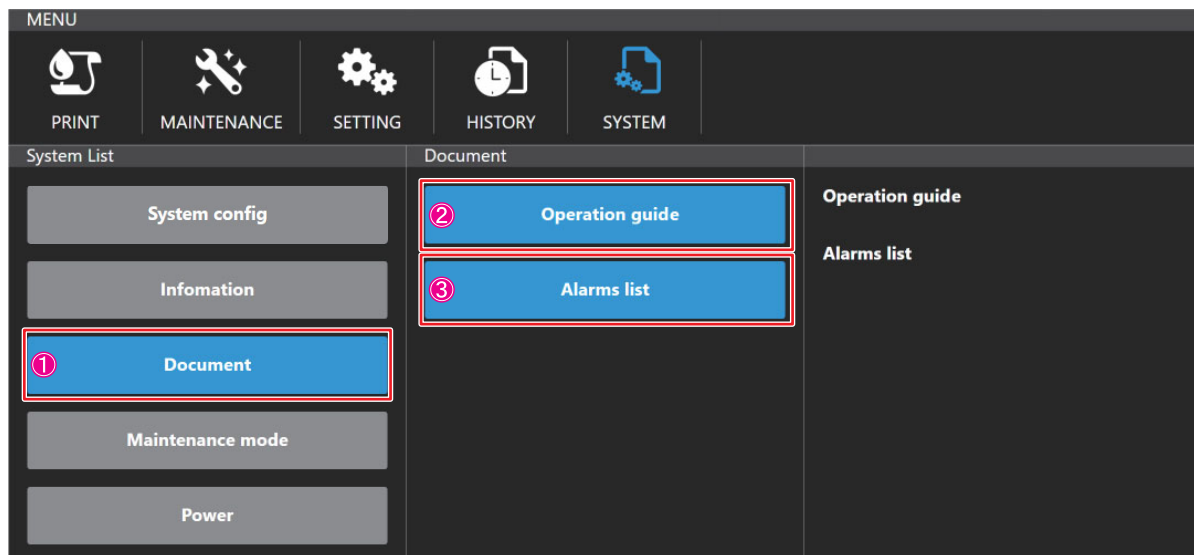
[Document]

No.	Name	Description
1	Document	The [Operation guide] and [Alarm list] menus are displayed.
2	Operation guide	The operation guide is displayed.
3	Alarm list	The alarm list is displayed.

[Maintenance mode]

This is a menu for service purpose. It can not be used.

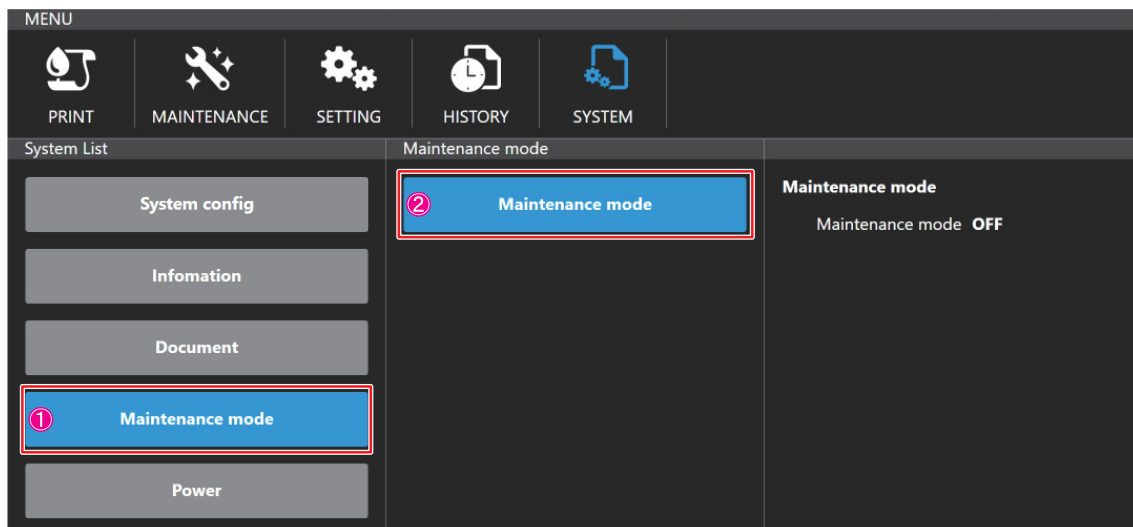

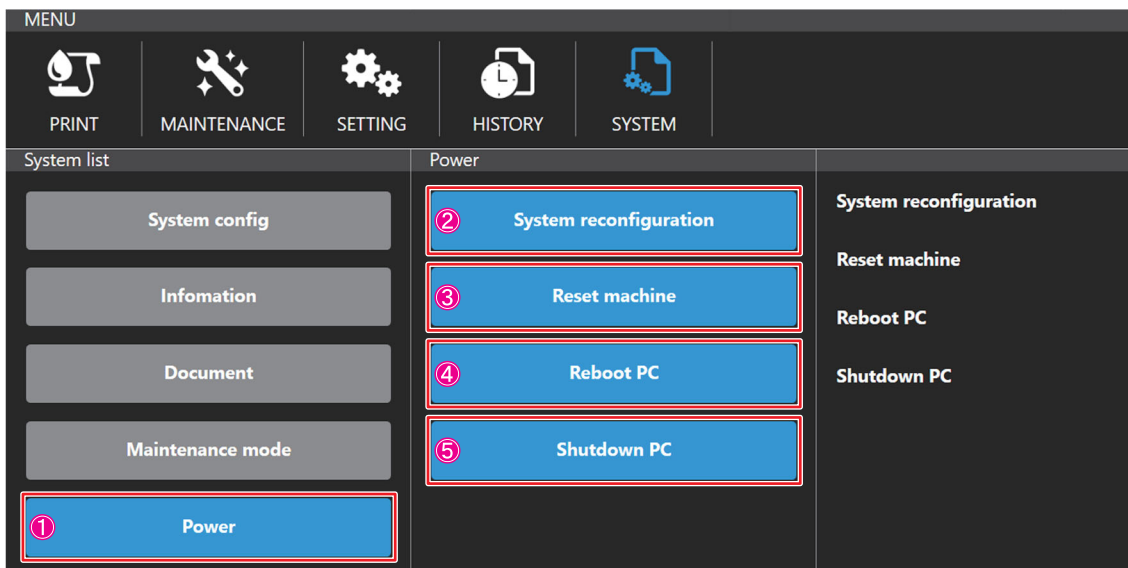



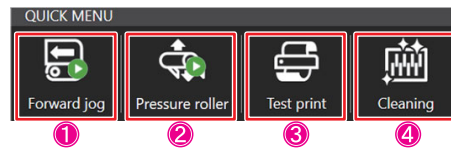

[Power]

No.	Name	Description
1	Power	The [System reconfiguration], [Reset machine], [Reboot PC], and [Shutdown PC] menus are displayed.
2	System reconfiguration	A confirmation dialog for system reconfiguration is displayed. Tap [OK] to reinitialize.
3	Reset machine	The confirmation dialog for machine reset is displayed. Tap [OK] to reset the machine. All ongoing operations will be reset.
4	Reboot PC	A confirmation dialog for restarting the PC is displayed. Tap [OK] to restart the PC. All ongoing operations will be reset.
5	Shutdown PC	A confirmation dialog for PC shutdown is displayed. Tap [OK] to shut down the PC. All ongoing operations will be reset.

Quick function

Execute the frequently used functions directly from shortcut icons.



No.	Name	Icon	Description
1	Forward jog	 Stop  Forward	Perform the forward jog operation.
2	Pressure roller	 Up  Down	Move up or down the pressure roller.
3	Test print		Perform a test print.
4	Cleaning		Perform cleaning.

Chapter 7

Operation, Adjustment, and Maintenance



This chapter

describes the basic operation method for this machine, as well as adjustment methods and maintenance.

Training to Workers (Operators)	7-2
Operators	7-2
Operator Work	7-2
Preparation Before Starting Work	7-2
Transport of Fabric	7-3
Printer	7-4
Pause	7-4
Long-term Suspension	7-4
Procedure for Cleaning and Adhesive Application	7-5
Preparation of Belt Cleaning Unit	7-5
Adjust the Squeegee Blade	7-5
Replacing Squeegee Blade	7-6
Belt Cleaning Procedure	7-10
Cleaning	7-10
Change Wiper Blade	7-11
Replacing Ink Tank	7-13
Refill the Cleaning Solution (Wiper Cleaning Solution)	7-16
Installation / Replacement of Waste Tank	7-18

Training to Workers (Operators)

- The personnel (operators and maintenance personnel) must participate to an on-site training by the Mimaki's engineer and they understand all the information provided in the operation manual (this manual), especially accident prevention and safety regulations.
- Employers are responsible for disclosing this document to all operators who operate this machine. In addition, the operator must be informed of the contents of this manual before handling this machine.



- In this manual, the protective symbols to be used are indicated by symbols so that they can be recognized at a glance.

Operators

The operators must meet the following requirements:

- General education and special education to the extent that a person can understand the content and charts of this manual and the messages and symbols displayed on the display of this machine correctly.
- Knowledge of both the machine and the product.

Operator Work

- Procedure of normal operation
 - media feeding in this machine
 - Preparation work before use
 - Activate this machine
 - Stop the machine
 - Emergency stop
 - Restart after an emergency
 - Confirmation of printed media
 - Cleaning up the machine and each unit
 - Normal maintenance

Preparation Before Starting Work

The machinery is adjusted and tested at Mimaki.

After the installation, the personnel authorized by Mimaki performs the last adjustments and initial startup.

No further adjustment is required.









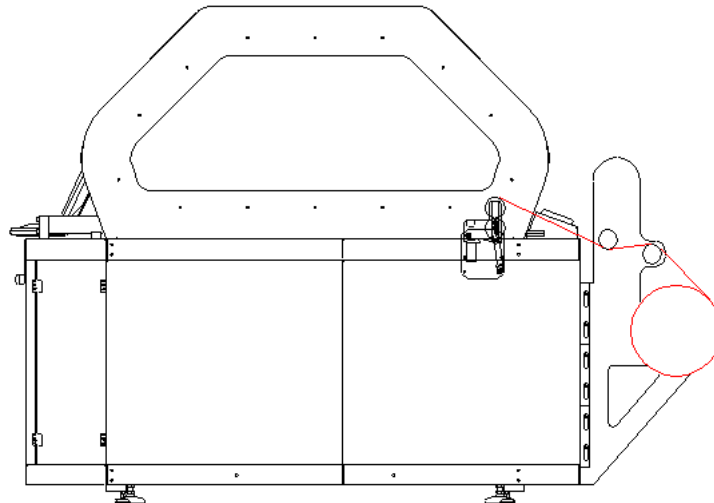

Confirmation of supply line in advance

Before the first start of the machine, the operator visually checks that all safety systems are functioning properly, check the direction of rotation and confirm that all the drive systems are properly connected.





Procedure		Confirmation of supply line in advance			
S	Mode	Key	Indication	Description	Reference
1				Confirm that the recovery work and the safety equipment for the emergency situation are ready.	
2				Confirm that adjustment of switching device has been done.	
3				Confirm that the charging of the machine is finished and the media has been transported.	
4		[GENERAL SWITCH]	0 - 1	Set the position of the main power switch to 1 to supply voltage to this machine.	5-2
5		P01 - No.1		If the white light on the push button panel (P01) is lit, the voltage is being supplied to the machine.	5-3
6		P01 - No.3	Reset emergency	If RESET EMERGENCY lights up, you need to restore the reset.	5-3
7		P01 - No.3	Reset emergency	Press and hold the RESET EMERGENCY button until it goes out.	5-3
8	AUT			When the RESET EMERGENCY button goes out, reset the software alarm.	
End of procedure					

Transport of media





Procedure		Transport of media			
S	Mode	Key	Indication	Operation	Reference
1			media LOAD - UNLOAD	Load the media roll to the air shaft.	2-2
2				Pass the media through two idle rollers.	
3		P02 - No.3	Pressure roller	Lift the pressure roller.	5-4
4				Pass the media through the pressure roller.	
5				Adhere the media to the conveyor belt.	
6		P02 - No.3	Pressure roller	Lower the pressure roller.	5-4
7				Set the jog mode on the operator panel.	
8				Control the operation of the belt.	
9				Release the media from the belt and insert it into the take-up unit.	
10		P02 - No.1	[PNEUMATIC BRAKE ADJUSTMENT] [ON] - [OFF]	If necessary, increase or decrease the tension of the media with the pneumatic brake adjustment lever.	5-4
11		Note 		Only run at low speed during the feeding operation.	
End of procedure					

Printer

Procedure		Start of printer operation			
S	Mode	Key	Indication	Operation	Reference
1			media LOAD - UNLOAD	Load the media roll to the air shaft.	2-2
2				Make sure the media is passing correctly.	7-3
3				Press [start] to start working on the printer. You can operate with the operator panel.	
4				The operator manages whether the operation is performed properly.	
5				After the printing and media taking-up, the operator unload the media roll.	
End of procedure					

Pause

To temporarily stop the unit, follow the procedure below.



Procedure		Pause			
S	Mode	Key	Indication	Operation	Reference
1				The operator stops the machine with the operator panel.	
2				Confirm stop of this machine.	
3		PEM	EMERGENCY	In case of emergency, press any emergency switch on this machine to stop.	5-4
End of procedure					



- We recommend that you stop the machine before the printed material comes to an end so as not to fail the collection of the media.

Long-term Suspension

To stop the machine during the holiday period and beyond 24 hours, follow the procedure below.

Procedure		Extended stop			
S	Mode	Key	Indication	Operation	Reference
1				Shut down the PC from touch panel [System] > [Power] > [Shutdown PC].	6-64
2					
3		[GENERAL SWITCH]	0 - 1	Set the main switch position on the front side of the electrical box to 0 to turn off the voltage.	5-2
End of procedure					



- Inform Mimaki beforehand if you stop the machine for more than 2 days. Mimaki maintenance workers need to carry out long-term preservation treatment of the head.

Procedure for Cleaning and Adhesive Application

When the adhesive is applied evenly to the belt, adhesiveness and stability of the media are ensured. This is an essential task to get the proper performance of the printer.

After a certain period of time, depending on the printing conditions, you can check whether the effectiveness of the adhesive is not falling.

In the event of ineffectiveness, it is necessary to completely remove the adhesive and then re-apply the new adhesive.









- Cleaning agents used for cleaning and adhesive for application include toxic and flammable substances.
- We recommend that you follow all safety instructions supplied by the supplier carefully.
- Mimaki is not responsible for the results of not following these guidelines.

Preparation of Belt Cleaning Unit

The machine is equipped with two rotating brushed belts.

To operate the belt cleaning unit, follow the procedure below.

Procedure		Preparation of belt cleaning unit			
S	Mode	Key	Indication	Operation	Reference
1				Make sure that the discharge valve is closed and that there is no dust or dirt in the tank.	
2				Change the operation time (frequency and function time) of the solenoid valve using a command from the computer, or directly fill the tank with water to the discharge level.	
3				In case of directly filling water, it is necessary to take out the tank according to the procedure described in this manual.	9-3
4	AUT			When the water reaches the maximum level, it is automatically discharged to the main drain of the plant.	
5				If you need to thoroughly clean the tank, open the exhaust exclusion valve. and empty it.	
6				Perform internal cleaning of the tank to remove residual ink, dust and dirt.	
7				Close the exhaust exclusion valve.	
8				Put clean water manually or using a solenoid valve from the PC.	
End of procedure					

Adjust the Squeegee Blade



- The installed squeegee blades could be different according to final configuration of the machine.

It is necessary to reconfirm the height of the squeegee blade. Especially check if noise increases or water drops are seen on the belt.

If the noise increases significantly after readjustment, first lower the height until the belt starts to get wet.

Next, increase the height again until the belt dries. We recommend you to check the entire belt.

Do not apply excessive pressure to the belt by squeegee blade and brush. Because the squeegee blade has a lot of noise, the belt adhesive layer wears out, and there is a possibility that the brush scatters water.

For the adjustment operation, refer the following procedure.

Procedure		Adjust the squeegee blade			
S	Mode	Key	Indication	Operation	Reference
1				Adjust the squeegee blade in the following cases. When water droplets are attached to the belt When noise and vibration increase	
2				Use the relevant control function to lower the rear part of the tank.	
3				Unlock the washing tank and remove it from the machine.	
4				Loosen the specified screw and adjust the position of the squeegee blade, then tighten the screw when it reaches the correct position.	

Adjust the squeegee blade

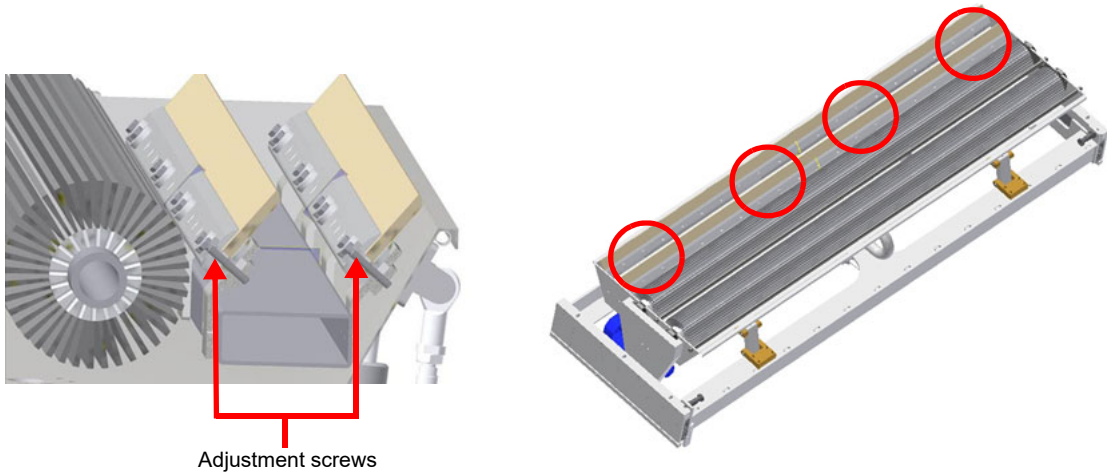







End of procedure

Replacing Squeegee Blade

The squeegee blade is a rubber device used to remove washing water from the belt.

Because the squeegee blade is made of rubber, it will not be possible to properly clean the work due to the influence of wear, depending on the type of treatment after a certain period of time.

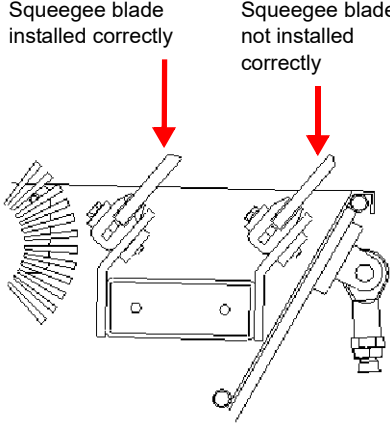
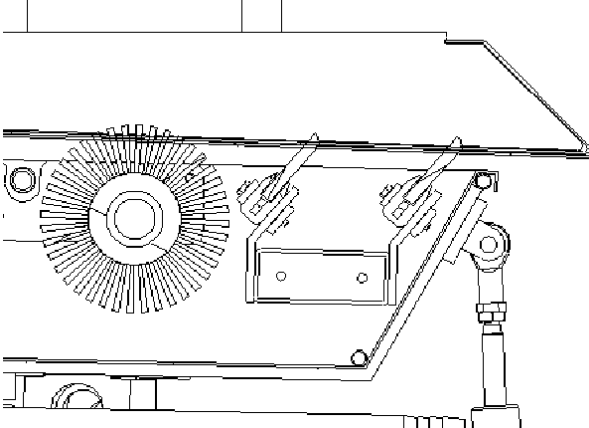
To replace, follow the procedure below.

Procedure		Replacing Squeegee blade			
S	Mode	Key	Indication	Operation	Reference
1				Use the relevant control function to lower the rear part of the tank.	
2				Unlock the washing tank and remove it from the machine.	
3				Remove the tightening screw using an appropriate size hex wrench.	
4				Remove the worn squeegee blade and replace it with a new one.	
5		NOTE		Pay attention to the installation position of the squeegee blade. The correct installation location is shown in the following Incorrect installation entails machine malfunction or damage to components.	
Installation of squeegee blade					
<div style="display: flex; justify-content: space-around; align-items: flex-start;"> <div style="text-align: center;"> <p>Squeegee blade installed correctly</p>  </div> <div style="text-align: center;"> <p>Squeegee blade not installed correctly</p>  </div> </div>					
6				Adjustment of squeegee blades then tighten the screws once the correct position is reached	
End of procedure					

Required material for applying adhesive to the belt

Table	Feature	Data
▶	Neutral base for adhesion	Unilevel ML ATR1948 Fortex S.p.A. 1 [Kg]
▶	Resin adhesive	Atrafix ML/K ATR1947 Fortex S.p.A 1.5 [Kg]
▶	Alcohol	100 [°]
▶	Adhesive paper tape	25 [mm]
▶	Solvent (for cleaning)	Persolvan NV Villa I.C.
▶	PET film for removing the bar after applying the lining agent	Width: 60 [mm] Length: 1650 [mm] Thickness: 1 [mm]

If you have never used the belt, clean it and remove any remaining dirt and dust.

Applying adhesive to the belt

For use in the textile printing model, we recommend that you prepare an adhesive at a 4:1 ratio of resin bonded type Atrafix ML/K ATR 1947 and neutral base Unilevel ML ATR 1948.

* The composition of the adhesive material depends on the media used.

Increase or decrease the percentage of resin to increase or decrease the fixing force of the media to the belt.





After mixing ingredients and preparing the amount of adhesive necessary for coating, follow the procedure below.



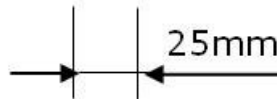



- Turn the exclusion key before doing this.
- Do not activate the heater during this operation. Also, turn off the cleaning system.

Procedure		Applying adhesive to the belt			
S	Mode	Key	Indication	Operation	Reference
1				We recommend that you attach two strips of adhesive tape (width 25 mm) to the end of the belt so that the adhesive does not leak out.	Figure below

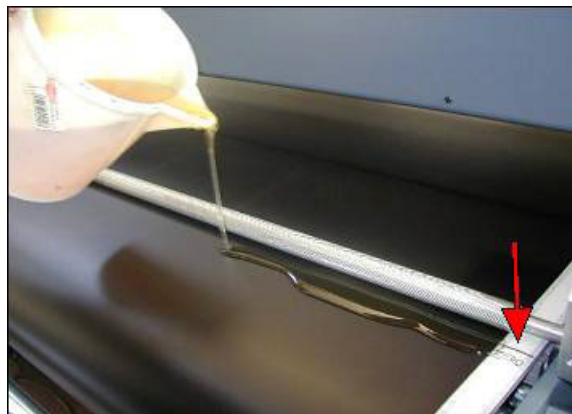





2				Set the belt jog reverse direction mode.	
3				Place the doctor to apply the agent to the support and evenly apply the first adhesive layer to the belt.	
4				We recommend that you attach an initial point (mark) to the adhesive tape so that you can see that the belt goes one rotation.	Figure below
5				Adhesive composition: 80% Atrafix ML/K ATR1947 Resin 20% Unilevel ML ATR1948 Neutral Base	7-8

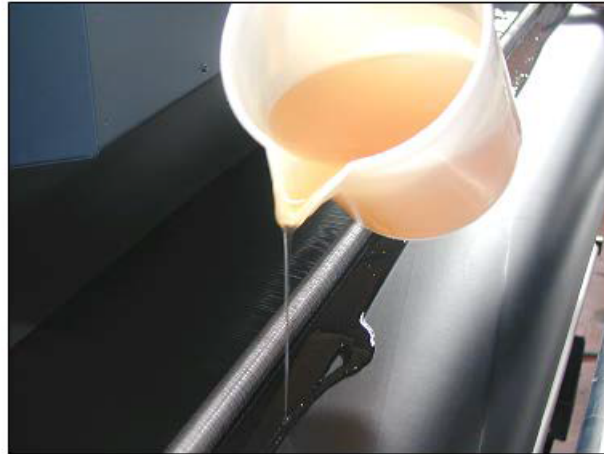

6				Use the appropriate command on the operator panel to initiate a manual backward movement.	
7	 			Apply the adhesive evenly to the belt.	Figure below



7

8				Once the adhesive is evenly spread over the entire surface of the belt, the operation is complete.	
9	 			Remove the doctor using a PET film (width 60 cm).	
10				Place the plastic stripe in front of the doctor while the belt is moving at reduced speed.	Figure below
11				When the PET film is under the doctor, stop the belt. Wrap the PET film around the doctor and remove it from the belt.	Figure below
End of procedure					

PET film





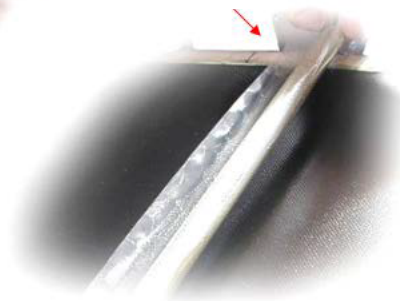

Removal of doctor



Belt Cleaning Procedure

If you need to remove the adhesive after using the printer, follow the procedure below.

Procedure		Belt cleaning procedure			
S	Mode	Key	Indication	Operation	Reference
1				Remove the washing tank so that the solvent used for cleaning will not damage the belt.	9-3
2				Protect print heads and cylinders	
3				While transferring the belt (such as applying the adhesive), apply the solvent type Persolvant NV evenly over the entire surface of the belt and remove excess adhesive with one or more cloths.	
4				It is recommended to use a nebuliser for the solvent application.	
5				Once all the residue is removed, you can apply a new layer of adhesive.	
End of procedure					

Cleaning

The print head station is on the carriage of the print head inside the printer structure.

When the carriage is in the rest position, the station contacts the printhead. At this location, the print head performs ink purge, after which the extra ink is removed and the print head is in the proper state due to the forward and backward movement of the station.

In the periphery of each head groove, there is a wiper that can remove ink from the print head.

Ink inside the unit is discharged from the station using an appropriate discharger (one for each unit) connected to the main drain of the machine.

The drain pipe of each head groove is in the raised position. There is always an ink layer for dampening the head with this method, but when the head groove is full, it is discharged to the bottom of the head groove through the discharge hole.

Cleaning is done to remove ink droplets from the head that affect printing on the media.

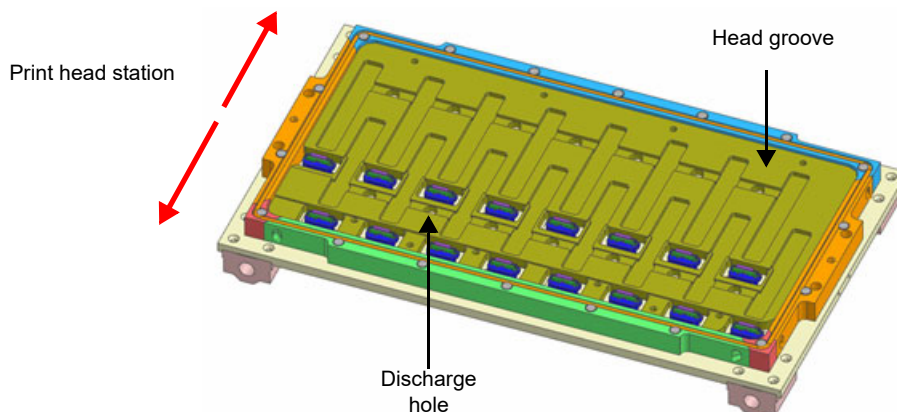

Change Wiper Blade

Estimated wiper replacement timing is once every 2 weeks.



- The operator should wear safety glasses and protective gloves before starting replacement work.



- Replacement of the wiper blade can also be performed by using [User maintenance] > [Maintenance wizard] from the [MAINTENANCE] menu in addition to the following methods.

- 1** Select [User maintenance] > [Carriage operation] from the [MAINTENANCE] menu in the touch panel.
- 2** Tap [To maintenance position] from the [Carriage operation] dialog.
 - The carriage moves to the maintenance position.
- 3** Press emergency switch for safety.
- 4** Open the right front cover.
- 5** Clean the station
 - Remove all ink from the station's head groove and wiper parts.

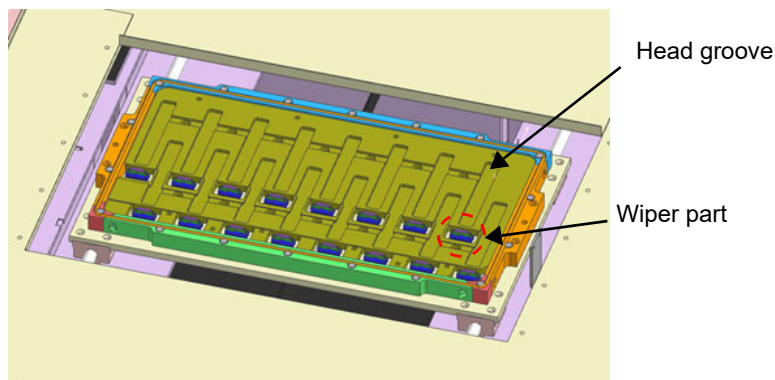

- 6** Lift the wiper holder while pushing the sections of it shown in the red circles inward (see the figure below) to remove the holder from the wiper holder mounting block.

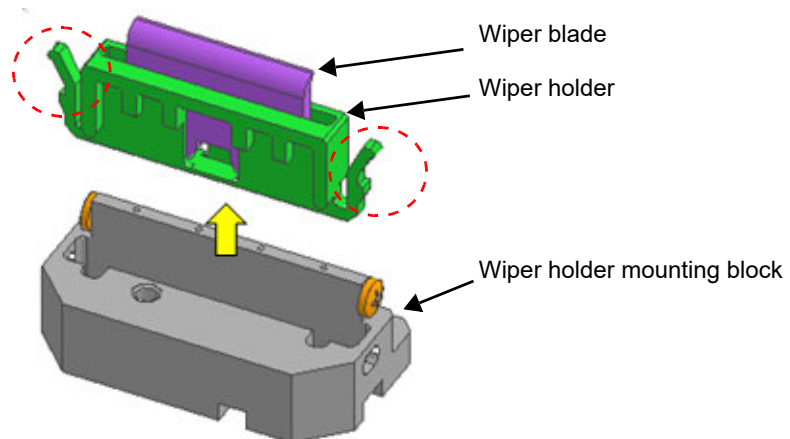

- 7** Remove the wiper blade from the wiper holder and then replace the blade with a new one.
 - Use the same wiper holder again.
 - Make sure that you attach the wiper blade in the correct orientation.

8

Attach the wiper holder to the wiper holder mounting block.

- Push the wiper holder until the parts of it shown in the dotted circle are engaged with the wiper holder mounting block.
- Make sure that the wiper holder does not come off if you pull it from the block.

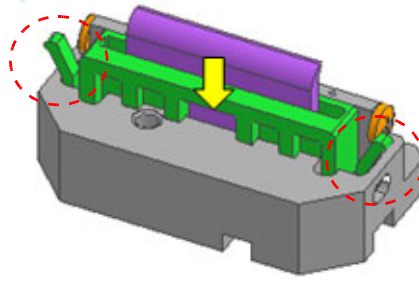

9

Close the cover.

10

Reset the emergency switch.

Replacing Ink Tank

● If "INK NEAR END" is displayed on touch panel

the ink level is low. Although you can continue printing, there is a risk that ink will run out during printing. We recommend that you replace the ink tank as soon as possible.

● If "INK END" is displayed on touch panel

replace with a new ink tank.



- Always wear gloves and safety glasses when replacing any ink tank.

1 Open the door on the right side of the main unit

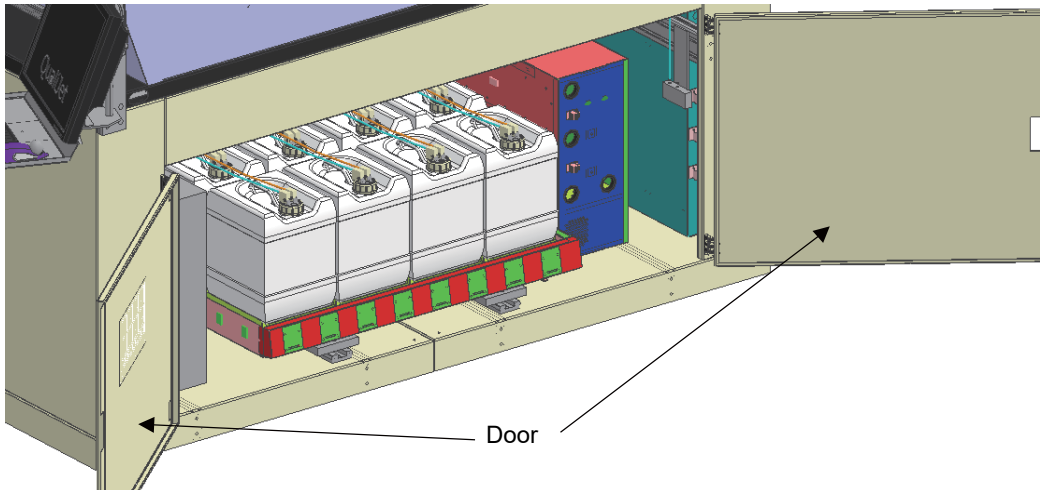

2 Pull out the ink tank tray toward you

- Pull out the ink tank tray slowly until it hits the front.
- The sensor detects the operation of pulling out the ink tank tray, "ERROR 66D Inktank pull out" is displayed on touch panel, and the operation of supply and circulation temporarily stops.

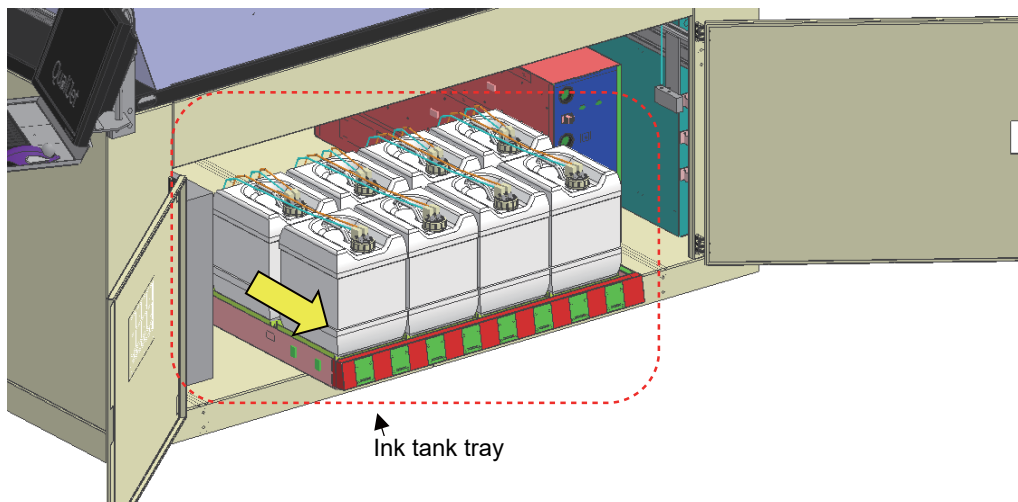

- Be sure to pull out the ink tank tray.
- If an ink tank is replaced without pulling out the ink tank tray, the operation of supply and circulation will not stop, and it possibly leads to damage to parts or ink leakage.

3 Shake the unopened new ink tank slowly right and left more than 20 times

- Wear gloves and shake the ink bottle to left and right more than 20 times while holding the lid of the bottle so that the ink flows slowly, in order for the ink not to be leaked when during shaking.



- Do it carefully because it may cause ink leak if shaking too strongly.

4

Remove the fitting from the cap of the ink tank and remove the ink tank from the ink tank tray

- When replacing the ink tank on the back side, first remove the ink tank in front.

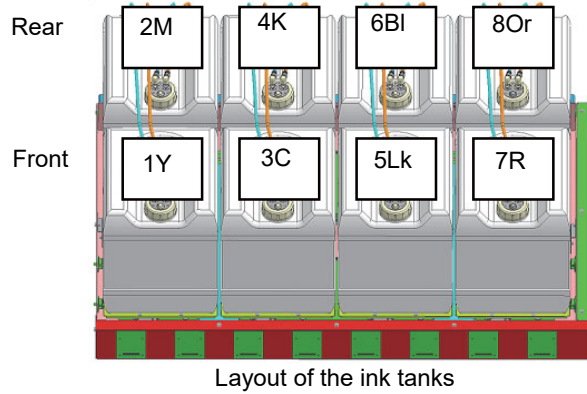
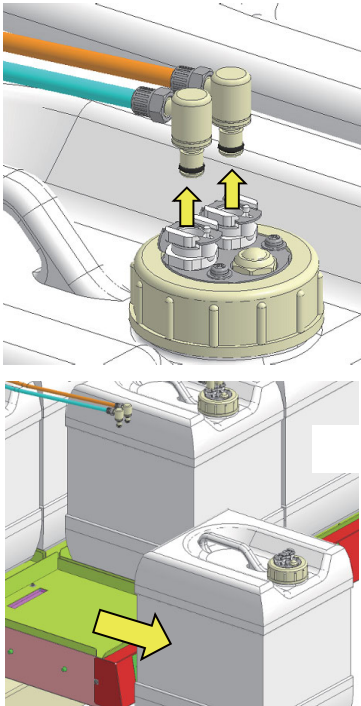

5

Turn off the cap of the ink tank and attach it to a new ink tank

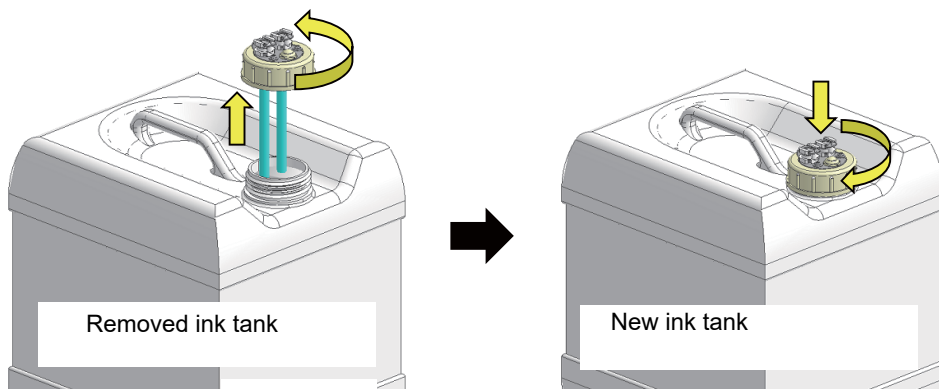

- When replacing the ink tank, ink may splash. Be sure to wear gloves and protective safety glasses.
- Cure the surroundings with a cloth before replacing the tank with a new ink tank. Ink may drip from the tip of the tube, and the surroundings may become dirty.

6 Place the new ink tank on the ink tank tray and attach the fitting

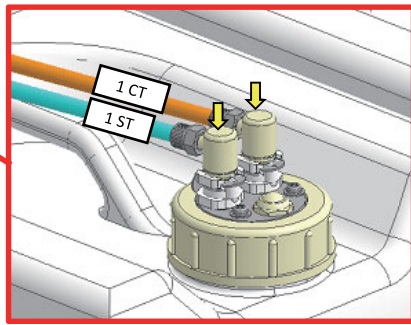
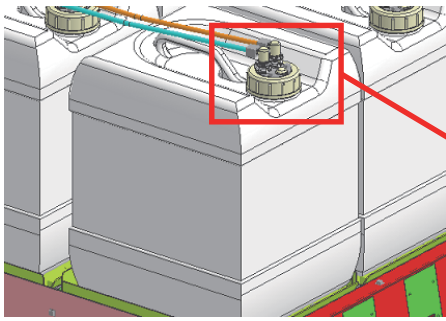

[How to read a tag]

- 1 ST
 - ST: Supply tube
 - CT: Circulation tube
- Path number (1 to 8)



- When removing multiple ink tanks, make sure that the tubes are connected properly and the ink tanks are placed correctly. It may cause color contamination and ink control malfunction.
- Two fittings (CT and ST) of the same tank cap can be connected to either way without problems.

7 Push the ink tank tray and close the door

- Gently push the ink tank tray until it hits the back.

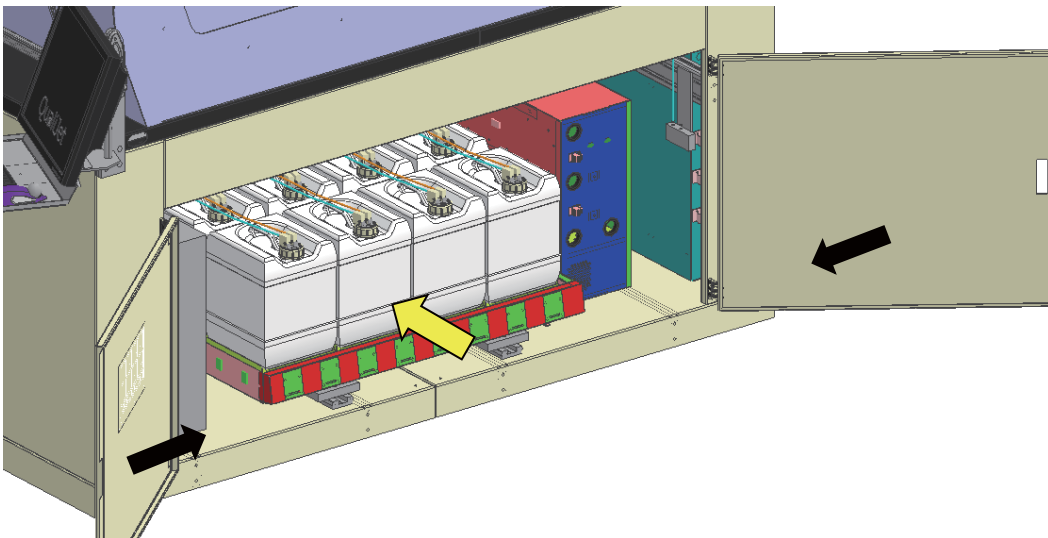

8 Tap the [CLEAR ALARM] button on the touch panel.

- “[1]: 066D: 09 (_____ 1) INKTANK PULL OUT” alarm disappears and supply / circulation operation resumes.

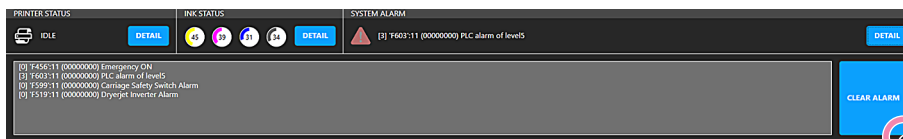

Tap the [CLEAR ALARM] button

Refill the Cleaning Solution (Wiper Cleaning Solution)

- Confirm the remaining amount once a day in the cleaning solution tank

Estimated refill period: once every 24 hours of printing time (in the case of auto cleaning 30 min)

If the remaining amount of cleaning solution is insufficient, "F466 Cleaning Solution LOW level Alarm" will be displayed on touch panel.

- When "F466 Cleaning Solution LOW level Alarm" is displayed on touch panel.

Cleaning solution for wiper cleaning is insufficient. Cleaning can not be performed while this alarm is occurring. Refill the cleaning solution tank.

- 1 Open the door on the back right side of the main unit.

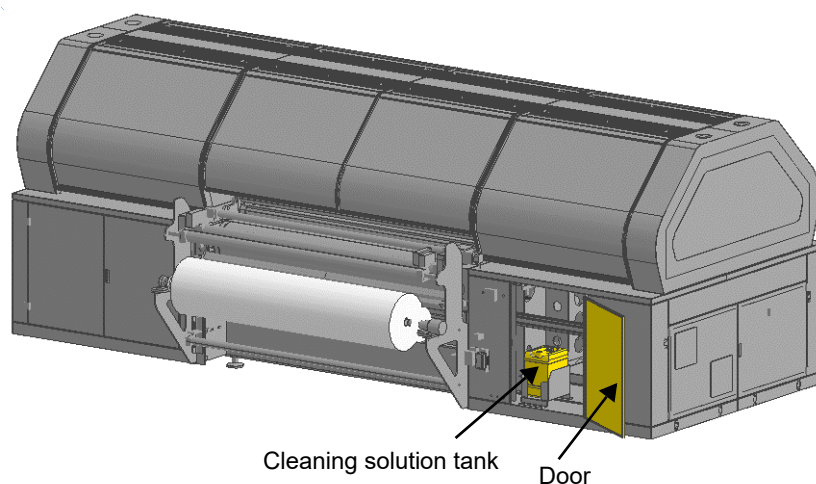

- 2 Remove the cap of the cleaning solution tank and take out the tank.

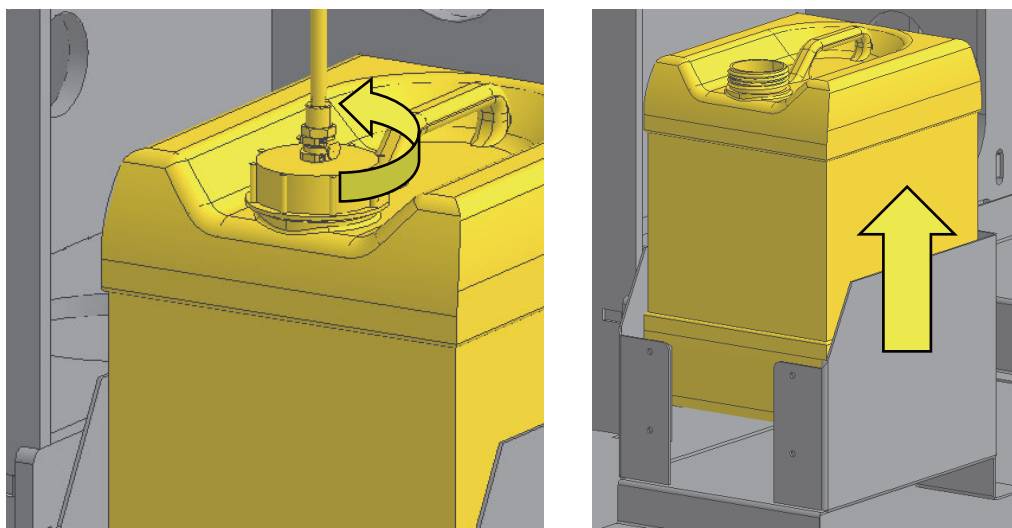

- 3 Refill the cleaning solution tank.

- 4** Return the cleaning solution tank to the specified position and attach the cap.

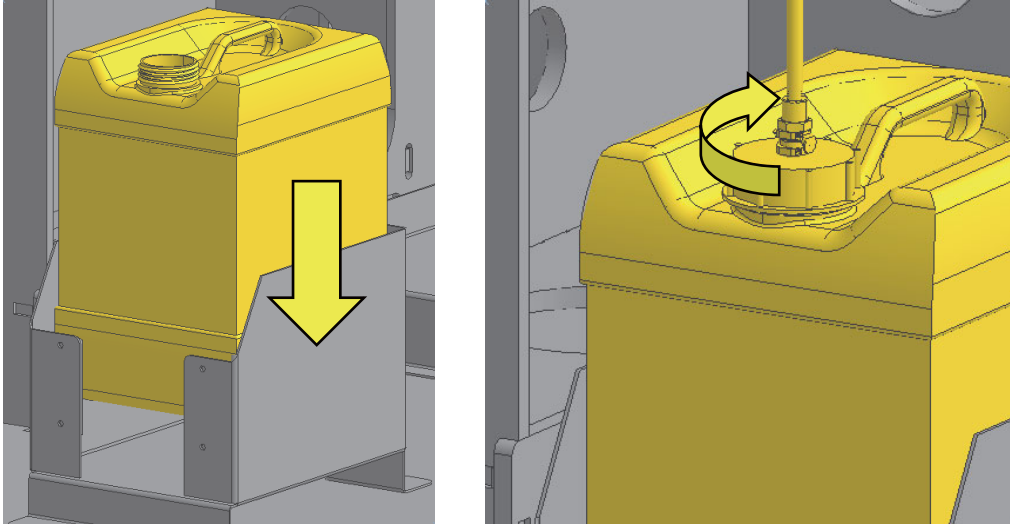

- 5** Tap the [CLEAR ALARM] button on the touch panel.

- “[1]: F466: 11 Cleaning Solution LOW level Alarm” alarm disappears and cleaning can be executed.

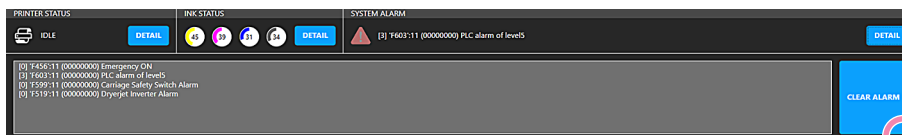

Tap the [CLEAR ALARM] button

Installation / Replacement of Waste Tank

A waste tank (20L tank recommended) is required for the waste at cleaning and the waste of the water absorption roller unit.

Confirm the amount of waste once a day in the waste tank and exchange it periodically.

Comply with the laws and regulations of each local government / region for disposal of the waste.



- Replace the waste tank when the machine is stopped.
- Always wear gloves and safety glasses when replacing the waste tank.

● Installation and replacement method

1

Install a waste tank in the space on the left side of the main unit.

- As a countermeasure against overflow of ink from the waste tank, we recommend installing stainless steel bat etc under the tank.

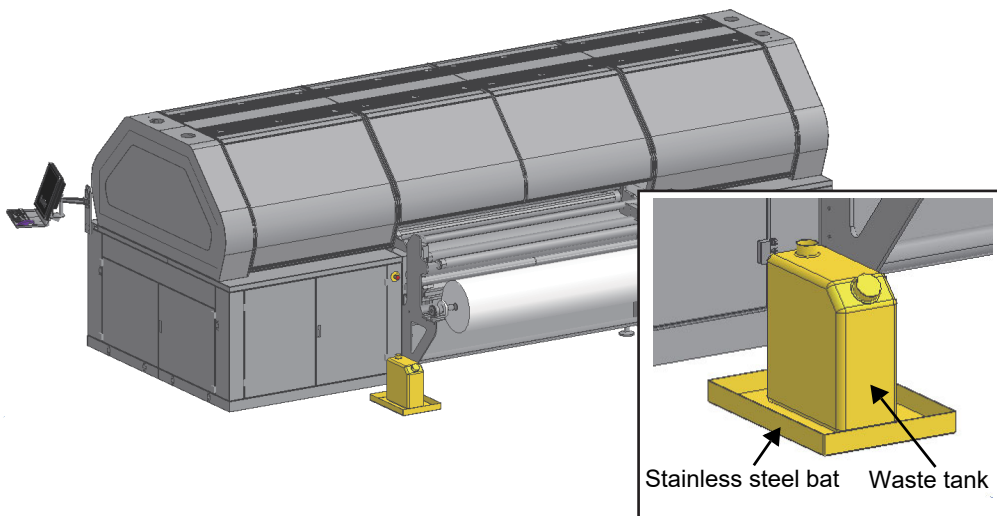

2

Insert two waste hoses (waste from the station / waste from the water absorption roller unit) into the waste tank.

- When replacing the waste liquid tank, ink remaining in the hose may drip. Recommend that you prepare and replace a spare tank.

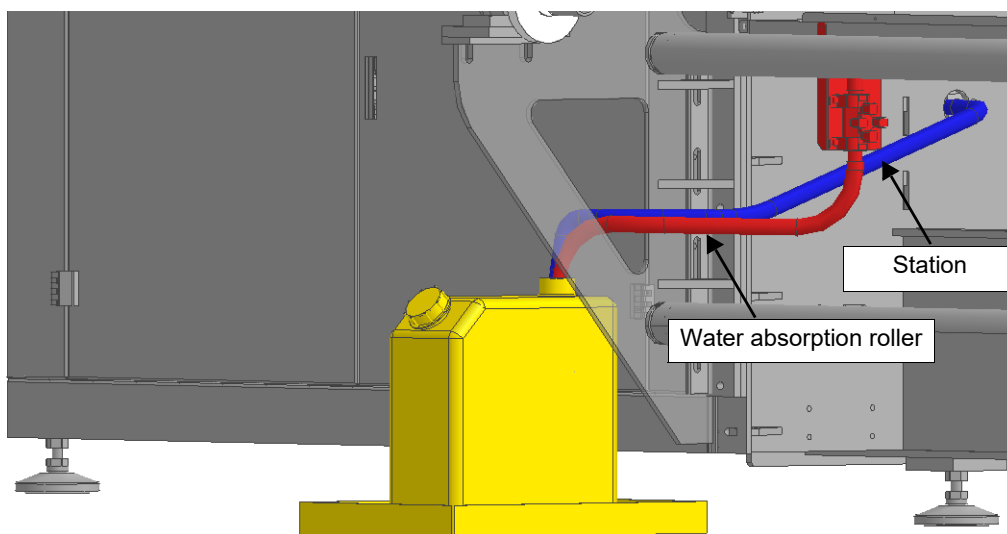

● Replacement procedure

(1) Gently pull up the waste hose from the waste tank.

- There is a possibility that the waste fluid splashes if you raise the tank vigorously.

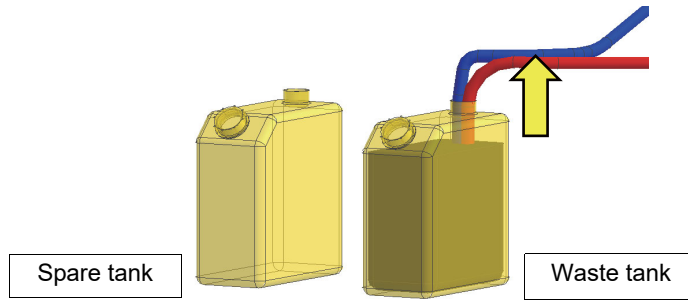

(2) Put the ink that remains in the waste hose into the waste tank.

- Do not put the waste hose completely out from the mouth of the waste tank.

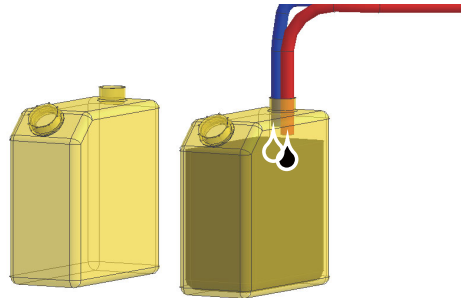

(3) Insert the waste fluid hose into the spare tank. Discard the ink in the waste tank.

- When moving the hose between the tanks, hold the outlet of waste hose with a cloth or something.
- Comply with the laws and regulations of each local government or region for disposal of the waste.

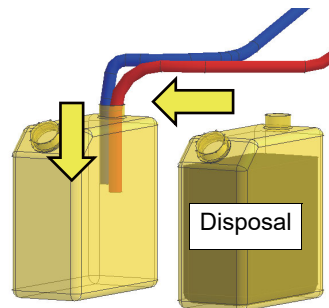

Chapter 8

Safety Devices and Residual Risks



This chapter

describes the safety devices attached to this machine, as well as residual risks.

Safety Devices	8-2
Residual Risks	8-3
Mandatory Requirements and Safety Precautions	8-3



- Mimaki is exempt from any responsibility for injury or damage to the parts when operating the machine in the absence of necessary safety conditions such as removing or passing through the safety guard.
- Mimaki is exempt from any responsibility for injury or damage to parts when improper mechanical changes are made to this machine or its parts.
- Mimaki is exempt from any responsibility for injury or damage to parts when using this machine for the purposes different from its machine design or the machine at purchased.

Safety Devices









- The customer is obliged to inform Mimaki in case of defect and / or malfunction of the protection systems and any potentially dangerous situation.

Emergency switch

Press the emergency switch to immediately stop any operation in progress and deactivate the controls (Emergency condition).

Warning light tells you whether the emergency switch is enabled or not. Warning light lights up to discover the emergency situation that occurred. To recover from an emergency, turn and release the emergency switch clockwise until the beep sounds.

Follow the procedure indicated below in order to reset the emergency switch.

Procedure		Reset of emergency switch			
S	Mode	Key	Indication	Feature	Reference
1	AUT. 	P01 - No.3	Reset emergency	When the warning light is on, the emergency switch is activated.	5-3
2	 			Check which push button was pressed. Removed the cause of the emergency.	
3		PEM	[EMERGENCY]	Turn and release the emergency switch clockwise until the beep sounds.	5-4
4		P01 - No.3	Reset emergency	Press the emergency reset switch until it turns off.	5-3
5	AUT. 			The warning light turns off indicating the reset of the emergency switch.	
End of procedure					

Passive safety device



- The customer is obliged to inform Mimaki in case of defect and / or malfunction of the protection systems and any potentially dangerous situation.

The passive safety device eliminates the risk of the operator. This risk varies depending on the targeted processing. This system reduces the risks that could not be eliminated at the design stage of this machine to an acceptable level and reduces the operator's active intervention required for preventive measures of the machine.

The main passive safety devices installed on the machine are:

Protective guard for mechanical parts of the machine: Prevents contact between the operator and the mechanical parts of this machine.

Hazard identification pictogram: Draws attention points that the operator should pay attention to dangerous parts of this machine.

Residual Risks

The operator should confirm that there are no foreign objects such as dust and oil in this machine.

For this reason, the operator needs to schedule a cleaning procedure at the end of the shift, with the machine switched off and with the help of assistants.



- When cleaning work using air pressure or water pressure, you need to use goggles and protective mask. All people near the machine must leave the area because they may be affected by substances and dust. Avoid that water jets and splashes directly reach the switchboards containing electrical equipment.

It is forbidden to use flammable fluids for cleaning operations. At the end of the cleaning procedure, the operator should visually check whether there are any worn or damaged parts (if they occurred, immediately ask for assistance of a maintenance expert), and whether the parts are firmly fixed (take action as best you can). Pay particular attention to the maintenance of electrical systems, hoses and other parts that are affected by wear and tear.



- If a fault condition is found, the operator should not start the machine until the problem is resolved. If these conditions are found at the end of the shift, the operator must put on a warning sign on the control panel indicating that the machine is being maintained and therefore its re-start is strictly forbidden, before leaving the workplace. The operator must remove all things that are not essential parts of the machine (such as tools that you left behind after maintenance work, codes used to handle parts, personal possessions, etc.) from the machine and its surrounding area.
- Operators and maintenance workers should wear practical and appropriate work clothes and do not wear necklaces or bracelets. It may be caught in moving parts of the machine. Also, long hair workers apply hair nets to prevent hair from getting caught.
- The protective guard and the safety device are not removed unless repair or maintenance work is required. When removing them, make sure to restore them to their original position as soon as you find the cause of the fault condition, and then restart the machine.

Mandatory Requirements and Safety Precautions

Dangerous voltage

In normal operating conditions (excluding electrical cabinet), there are no components of the machine affected by hazardous voltages. The parts subject to dangerous voltage in the electrical cabinet are protected by the door of the cabinet that are locked.



- Before performing any maintenance or repair work in the machine or electrical cabinet, it is necessary to disconnect the power supply with the master switch of the electrical cabinet.

Residual voltage



- There is no condenser in the electrical cabinet that voltage may remain. But even if the master switch of the electric cabinet is OFF (position to 0), the electrical cable in the vicinity of the switch is still charged. The power cable connected to the terminal is protected with a special transparent plastic cover. The location of residual voltages is shown in the map enclosed with the electric circuit diagram. The location of the residual voltage is shown in the map attached to the electric circuit diagram.

There is a connecting condenser CC inside the frequency converter (inverter) used for adjusting the speed rotation of the transport roller and take-up roller. This is affected by a very high and dangerous voltage even when the power is turned off.



- The frequency converter can be opened after 10 minutes or more have elapsed since the power is turned off. After opening, parts are affected by voltage, so do not touch that part.
- Due to the clamping of the device, high voltage may occur even if the converter is not functioning.

Dangerous zone

To avoid risks, please never stay in the indicated area (in the red diagonal, below) while the machine is running.



- The machine must be operated by a single operator. Multiple operators are allowed only in case of loading and unloading rolls.

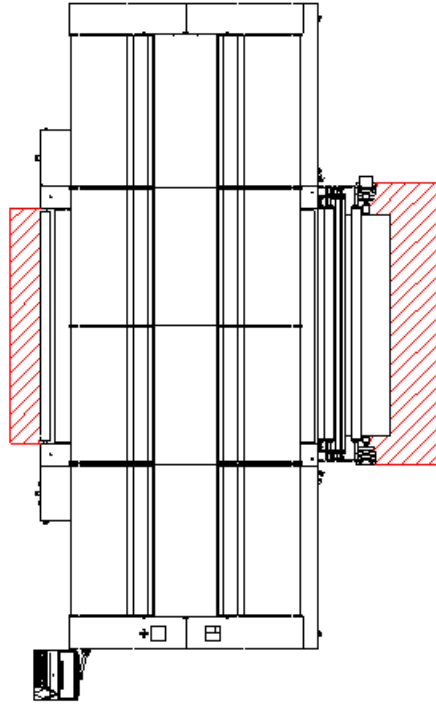

Chapter 9

Maintenance



This chapter

describes the maintenance of this machine to be performed by the operator.

Maintenance Overview	9-2
Ordinary Maintenance	9-2
Scheduled Maintenance	9-2
Summary Table for Maintenance Work	9-4
Special Maintenance	9-4
Troubleshooting	9-5
Error list (PLC)	9-5
Error list (Analysis Application "NZCApp")	9-17
Error list (Other)	9-18
Dismantling	9-27

Maintenance Overview

The essential condition for maintaining this machine efficiently and at a high level of reliability is to maintain accurate and consistent maintenance.

Focus on the following operations carefully.

Warnings about maintenance

- It is usually obliged during any maintenance work, regardless of ordinary or special work, to remove voltage from this machine before the work, and wear personal protective equipment, such as gloves, coveralls, and goggles, at all stages of it.
- Do not leave tools on the machine.
- Always follow the instructions listed in this manual.
- For any other maintenance that is not explained in this manual, contact our company.

Operations with specific technical knowledge

The operator can only perform the cleaning work of this machine.

Mechanical work and electrical work are performed by a maintenance worker.

Special maintenance work is done by an official approved by Mimaki.

Ordinary Maintenance

Regular maintenance work is carried out without determining the specific cycle in advance. It is based on operator's judgment and common sense.



- Regular maintenance work is prohibited while the machine is operating and receiving voltage. Wait for completion of the operation cycle before starting the regular maintenance procedure, turn the main switch position to 0 to turn off the machine.

Cleaning

Clean this machine every 1 working day (8 hours) to maintain a normal and safe working environment. So, keep the identification symbols readable clearly.

Also a proper and frequent cleaning of the area around the machine improves the healthiness of the work area and makes the walking areas safer.



- Before starting cleaning operations, the operator must wear protective clothes.
- Do not leave tools on the machinery at the end of maintenance operation.

For the clearing of transparent parts, control panels and parts made of rubber or cloth, use only neutral detergents such as soap. When using a solvent other than a neutral detergent, trichlorethylene or the like, there is a possibility that such parts can not be repaired.

When cleaning, do not use aqueous solution or flammable solution in electrical parts such as connector block or electrical equipment. In particular, never leave the door of the electric cabinet open during cleaning. This is because the electric and electronic equipment does not get uninsulated due to water splashes. Any uninsulated equipment can cause electrocution or fire.

Scheduled Maintenance

Scheduled maintenance work will be performed at intervals predetermined by us.



- Scheduled maintenance work is prohibited while the machine is operating and receiving voltage. Wait for completion of the operation cycle before starting the scheduled maintenance procedure, turn the main switch position to 0 to turn off the machine.

Safety Devices

Confirm that the electrical safety devices (switches, sensors, etc) of the machine are operating properly every 1 working day (8 hours). If there is an abnormality, reset the normal operating conditions before starting the work.

Note that a wire break or failure of one of these devices determines the immediate arrest of the machinery.

Their malfunction can then only be due to the possible detachment from the fixed point or the break that causes a short circuit.

For internal safety features and under more protected conditions, a less frequent control is sufficient; It can be done during the ordinary maintenance operations which require the opening of the protective guard.

The position of all safety electrical devices is shown on the electric circuit diagram.

Pneumatic system

Every 50 hours, check the proper operation of the pneumatic cylinder and all pneumatic devices on the machine.

Checking ink discharge

Regularly check whether ink is discharged correctly. Since the ink contains no toxic or harmful ones, it is discharged in clean water in the tank.

Reapplying the main belt adhesive





At the end of each shift, verify the layer of permanent adhesive on the belt and reapply it if necessary by following the procedures described in this manual ([Procedure for Cleaning and Adhesive Application \(P.7-5\)](#)).

Checking ink level

Periodically check the ink levels in the tanks and if the level in a tank has reached the minimum level, replenish the tank with the ink.

Confirming the belt cleaning unit

To inspect and clean the belt cleaning unit, you need to proceed as follows.

Procedure		Checking brush washing tank			
S	Mode	Key	Indication	Feature	Reference
1				Verify that the drain is properly connected with the main drain system.	
2		Main switch	0 - 1	After stopping the machine, turn the main switch to "0".	5-2
3				Disconnect the tank from the electric, pneumatic and hydraulic connections.	
4				Completely empty the washing tank by turning the valve.	
5				Press on the locking system of the tank, manually remove it and perform necessary maintenance.	
End of procedure					

Cleaning the station

Clean the print head washing station once a week, and eliminate ink residues ([P.7-10](#)).

Maintenance around the print head

Clean around the print head once a week using a dedicated cloth. During this operation, move the carriage to the left side of the machine.

For more information on maintaining the print head, see the dedicated manual.



- Mimaki assumes no responsibility for any injury or property damage caused by negligence in carrying out the scheduled maintenance operations of the print head.
For the maintenance of the print head, see the manual provided by the manufacturer.

Summary Table for Maintenance Work

The table below shows maintenance work and the relative frequency (expressed in working hours).

Table	Hour	Operation
▶	8	Checking safety device
▶	8	General cleaning of the machine
▶	8	Checking the cleaning solution tank
▶	8	Checking ink level
▶	8	Check the belt washing tank
▶	8	Checking belt adhesive layer
▶	40	Cleaning print head washing station
▶	40	Cleaning print head (attached manual)
▶	50	Checking pneumatic system
▶	336	Replacing wiper blade
▶	500	Checking condensate level in air filter
▶	500	Cleaning filter element in air filter
▶	500	Checking air supply pressure
▶	500	Checking fittings and pipes



- Mimaki assumes no responsibility for any injury or property damage caused by negligence in carrying out the maintenance work described in this manual.

Special Maintenance

Special maintenance work for equipment is performed in case of breakdown or breakage or when predictable technical update is done.

Scope of special maintenance

- Repair the damage.
- Adapt the machinery to Safety Regulations that come into force after the installation.
- By applying technological changes such as attaching accessories and units, adapt the machine to the planned state at design time (but limited to work that does not reduce the safety level at the design stage).



- Consider the following suggestions as appropriate means, before starting maintenance work:

- Check the training level of the operator involved in the work to be performed.
- Verify the need to use special tools and equipment to perform the disassembly, reassembly and any adjustment.
- Verify the availability or the existence of commercial parts that may be replaced by consulting the spare parts list.
- Verify the possibility to repair worn or broken parts with the aid of means internal or external to the company.
- Establish the power connection required for the operation.
- Evaluate the possible residual risks.
- Take the necessary precautions against residual risks.
- Assess emergency situations that may arise during the operation.
- Establish the checks to be carried out after the operation.
- Evaluate whether the support of Mimaki's technical staff is required. Or ensure a remote technical support for suggestions and precautions to be taken. For this purpose, contact Mimaki directly.



- Mimaki assumes no responsibility for injury or property damage and unnecessary changed at the design stage caused by maintenance work performed by an untrained operator or in the situation where safety precautions necessary for the maintenance work are not taken (or both).

We recommend that at the end of special maintenance work, the operator keeps a note of the reason, date of execution, and head of the intervention on the machinery as technical data.

Troubleshooting



- It is necessary to have accurate technical knowledge and professional skills to carry out any work of this machine. Required the operation by specialized staffs.
- The staff must create all conditions required by the laws in force concerning safety in permanent or temporary jobs, or both.

Error list (PLC)

Error No.	Error level	Error displayed	Cause	Measures
F372	0	Dryerjet Paper Dancing Bar out of reference position	The Dancing bar of Dryerjet Paper must be lower than the set position when performing reverse jog.	<ol style="list-style-type: none"> 1. Check the value of the air pressure adjustment valve that controls the weight of the dancing bar. With the feeding operation stopped, confirm that the air pressure measured on the valve is less than 1.5 Bar.
F373	0	Unwinder Paper Dancing Bar out of reference position	The Dancing bar of Unwinder Paper must be lower than the set position when performing reverse jog.	<ol style="list-style-type: none"> 2. Check if the shaft is not spinning idle. <ol style="list-style-type: none"> (1) Please insert pressured air into the shaft again. (2) Make sure that there is no air leakage from the shaft. (from a valve, etc.) (3) Please try changing the paper tube. 3. Check that the media surface treatment is not too sticky or old. Media may be not unwind properly because the coating adheres between the media windings. If necessary, replace the media. 4. Check if the media is not easily peeled off from the belt due to the excessive adhesive strength of the adhesive applied to the belt. In this case, when the media reaches the outside of the belt, it will not come off immediately and may adhere to the belt more than necessary. In that state, the media continues to be pulled by the weight of the dancing bar, so that the media suddenly comes off the belt causing the dancing bar to fall off at once.
F427	1 or 2	Unwinder big diameter Alarm	The diameter of the media installed on UNWINDER unit is too large.	<ol style="list-style-type: none"> 1. Check the diameter of the media installed in the UNWINDER. The maximum diameter is $\phi 1000\text{mm}$. If the diameter is over 1000mm, replace the roll. 2. If the dancing bar is lowered too much during a jog or feed and the media is slack, readjust it so that it does not slack. 3. Tap the [DETAIL] button in [SYSTEM ALARM], and tap the [CLEAR ALARM] button. 4. If the alarm appears again even after tapping the [Alarm Clear] button, turn off the power of the built-in PC and then the printer. After a while, turn on the power of the printer and then the PC. 5. If the Alarm appears again, contact your local distributor, our sales office, or service center.
F431	2	Dryerjet Hot Door Alarm	Media entrance door error on DRYERJET	<ol style="list-style-type: none"> 1. Close the cover of the DRYERJET media entrance. 2. Tap the [DETAIL] button in [SYSTEM ALARM], and tap the [CLEAR ALARM] button. 3. If the alarm appears again even after tapping the [Alarm Clear] button, turn off the power of the built-in PC and then the printer. After a while, turn on the power of the printer and then the PC. 4. If the Alarm appears again, contact your local distributor, our sales office, or service center.

Error No.	Error level	Error displayed	Cause	Measures
F432	1 or 2	DRYERJET Winder big diameter Alarm	The diameter of the wound media on the DRYERJET is too large.	<ol style="list-style-type: none"> 1. Check the diameter of the wound media. The maximum diameter is $\phi 500\text{mm}$. If the diameter is over 500mm, replace the roll. 2. If the dancing bar is lowered too much during a jog or feed and the media is slack, readjust it so that it does not slack. 3. Tap the [DETAIL] button in [SYSTEM ALARM], and tap the [CLEAR ALARM] button. 4. If the alarm appears again even after tapping the [Alarm Clear] button, turn off the power of the built-in PC and then the printer. After a while, turn on the power of the printer and then the PC. 5. If the Alarm appears again, contact your local distributor, our sales office, or service center.
F437	2	DRYERJET Communication Alarm	Communication error between DRYERJET and the machine	<ol style="list-style-type: none"> 1. Tap the [DETAIL] button in [SYSTEM ALARM], and tap the [CLEAR ALARM] button. 2. If the alarm appears again even after tapping the [Alarm Clear] button, turn off the power of the built-in PC and then the printer. After a while, turn on the power of the printer and then the PC. 3. If the Alarm appears again, contact your local distributor, our sales office, or service center.
F440	2	Purge not started Alarm	PLC Parameter Error	
F445	1	Current heater MIN	Belt heater current error (Lower than the set lower limit)	
F446	2	Current heater MAX	Belt heater current error (Higher than the set upper limit)	
F452	3	Belt generic Fault	Belt control error	
F453	3	Carriage generic Fault	Carriage control error	
F454	3	Carriage thermoswitch Alarm	Linear motor error	
F456	3	Emergency ON	Emergency switch or area sensor error	

Error No.	Error level	Error displayed	Cause	Measures
F457	3	Carriage sensor UP position Alarm	Carriage height sensor error	<ol style="list-style-type: none"> 1. Tap the [DETAIL] button in [SYSTEM ALARM], and tap the [CLEAR ALARM] button. 2. If the alarm appears again even after tapping the [Alarm Clear] button, turn off the power of the built-in PC and then the printer. After a while, turn on the power of the printer and then the PC. 3. If the Alarm appears again, contact your local distributor, our sales office, or service center.
F458	3	Carriage Up Motor Alarm	Carriage up/down motor error	
F459	3	Carriage Down Motor Alarm		
F460	3	Carriage Homing sensor Alarm	Carriage initial position check error	
F461	3	Motors Thermic Alarm	Motor or power breaker error	
F462	3	Washing device in maintenance position (FC S27.1)	Washing unit error	<ol style="list-style-type: none"> 1. Take the washing unit in and out, and tap the [DETAIL] button in [SYSTEM ALARM], and then tap the [CLEAR ALARM] button to check whether the error can be reset. 2. If the alarm appears again even after tapping the [Alarm Clear] button, turn off the power of the built-in PC and then the printer. After a while, turn on the power of the printer and then the PC. 3. If the Alarm appears again, contact your local distributor, our sales office, or service center.
F463	3	Cleaning Station sensors Alarm	Cleaning station sensor error	<ol style="list-style-type: none"> 1. Tap the [DETAIL] button in [SYSTEM ALARM], and tap the [CLEAR ALARM] button. 2. If the alarm appears again even after tapping the [Alarm Clear] button, turn off the power of the built-in PC and then the printer. After a while, turn on the power of the printer and then the PC. 3. If the Alarm appears again, contact your local distributor, our sales office, or service center.
F464	3	Cleaning Station Forward motor Alarm	Cleaning station motor error	
F465	3	Cleaning Station Backwards motor Alarm		
F466	1	Cleaning Solution LOW level Alarm	Error of the remaining amount of cleaning solution	<ol style="list-style-type: none"> 1. Check the remaining amount of cleaning solution. 2. Add the cleaning solution if necessary. 3. Tap the [DETAIL] button in [SYSTEM ALARM], and tap the [CLEAR ALARM] button. 4. If the alarm appears again even after tapping the [Alarm Clear] button, turn off the power of the built-in PC and then the printer. After a while, turn on the power of the printer and then the PC. 5. If the Alarm appears again, contact your local distributor, our sales office, or service center.
F467	2	Muting - Printing AREA doors	The cover sensor detection exclusion key is on.	<ol style="list-style-type: none"> 1. Turn Off the "EXCLUSION SAFETY DOOR" key on the right front side of the machine. 2. Tap the [DETAIL] button in [SYSTEM ALARM], and tap the [CLEAR ALARM] button. 3. If the alarm appears again even after tapping the [Alarm Clear] button, turn off the power of the built-in PC and then the printer. After a while, turn on the power of the printer and then the PC. 4. If the Alarm appears again, contact your local distributor, our sales office, or service center.
F468	2	Compressed Air LOW pressure Alarm	Air pressure error	<ol style="list-style-type: none"> 1. Check the air pressure supplied to the machine. Required pressure: 6 to 8 bar 2. After checking, tap the [DETAIL] button in [SYSTEM ALARM], and tap the [CLEAR ALARM] button. 3. If the alarm appears again even after tapping the [Alarm Clear] button, turn off the power of the built-in PC and then the printer. After a while, turn on the power of the printer and then the PC. 4. If the Alarm appears again, contact your local distributor, our sales office, or service center.

Error No.	Error level	Error displayed	Cause	Measures
F469	1 or 2	UNITECH HEATER Generic Alarm	Alarm generated in UNITECH HEATER	<ol style="list-style-type: none"> 1. Remove the cause of alarm of UNITECH HEATER. 2. Tap the [DETAIL] button in [SYSTEM ALARM], and tap the [CLEAR ALARM] button. 3. If the alarm appears again even after tapping the [Alarm Clear] button, turn off the power of the built-in PC and then the printer. After a while, turn on the power of the printer and then the PC. 4. If the Alarm appears again, contact your local distributor, our sales office, or service center.
F471	3	Printing position settings Alarm	Carriage print position setting error	<ol style="list-style-type: none"> 1. Tap the [DETAIL] button in [SYSTEM ALARM], and tap the [CLEAR ALARM] button.
F472	3	Carriage printing height setting Alarm	Carriage print height setting error	<ol style="list-style-type: none"> 2. If the alarm appears again even after tapping the [Alarm Clear] button, turn off the power of the built-in PC and then the printer. After a while, turn on the power of the printer and then the PC. 3. If the Alarm appears again, contact your local distributor, our sales office, or service center.
F473	0 or 2 or 3	Folds Alarm	The media floated The carriage jam sensor has responded.	<ol style="list-style-type: none"> 1. Set again so that the media does not float off the belt. 2. Tap the [DETAIL] button in [SYSTEM ALARM], and tap the [CLEAR ALARM] button. <p>If the media continues to float :</p> <ol style="list-style-type: none"> 3. Adjust the pressure of the pressure roller. 4. Turn on the belt heater. 5. Replace the adhesive. <ol style="list-style-type: none"> 6. If the above measures do not resolve the error, tap the [DETAIL] button from [SYSTEM ALARM], and then tap the [CLEAR ALARM] button. 7. If the alarm appears again even after tapping the [Alarm Clear] button, turn off the power of the built-in PC and then the printer. After a while, turn on the power of the printer and then the PC. 8. If the Alarm appears again, contact your local distributor, our sales office, or service center.
F474	3	Carriage lateral folds safety device Alarm	Carriage crashed into the media.	<ol style="list-style-type: none"> 1. Remove the contact media and set it again. 2. Tap the [DETAIL] button in [SYSTEM ALARM], and tap the [CLEAR ALARM] button. 3. If the alarm appears again even after tapping the [Alarm Clear] button, turn off the power of the built-in PC and then the printer. After a while, turn on the power of the printer and then the PC. 4. If the Alarm appears again, contact your local distributor, our sales office, or service center.
F475	3	Purge quote too low (3[mm])	Purge position setting error	<ol style="list-style-type: none"> 1. Tap the [DETAIL] button in [SYSTEM ALARM], and tap the [CLEAR ALARM] button.
F476	3	Cycle doesn't START - Maintenance Enable reason	Under maintenance	<ol style="list-style-type: none"> 2. If the alarm appears again even after tapping the [Alarm Clear] button, turn off the power of the built-in PC and then the printer. After a while, turn on the power of the printer and then the PC.
F487	3	Carriage movement Safety PX Alarm	PLC parameter error or Carriage up / down operation error	<ol style="list-style-type: none"> 3. If the Alarm appears again, contact your local distributor, our sales office, or service center.
F488	2	Belt Heater Alarm	Belt heater error	

Error No.	Error level	Error displayed	Cause	Measures
F489	1 or 2	MEDIA END Alarm	The media end was detected in the UNWINDER unit.	<ol style="list-style-type: none"> 1. Check if there is a hole in the media coming out of the UNWINDER unit. If there is a hole, feed the media until it comes out of the print area, then tap the [DETAIL] button in [SYSTEM ALARM], and tap the [CLEAR ALARM] button. 2. If the alarm appears again even after tapping the [Alarm Clear] button, turn off the power of the built-in PC and then the printer. After a while, turn on the power of the printer and then the PC. 3. If the Alarm appears again, contact your local distributor, our sales office, or service center.
F512	2	Unwinder Dancer Roll Up Alarm	Dancing bar of the feeding unit has reached its upper limit.	<p>[For Unwinder Paper]</p> <ol style="list-style-type: none"> 1. Level the dancing bar in the local mode. (Manual feed etc.) 2. Check that the operation mode of the UNWINDER unit is set to Auto. 3. Tap the [DETAIL] button in [SYSTEM ALARM], and tap the [CLEAR ALARM] button. 4. If the alarm appears again even after tapping the [Alarm Clear] button, turn off the power of the built-in PC and then the printer. After a while, turn on the power of the printer and then the PC. 5. If the Alarm appears again, contact your local distributor, our sales office, or service center. <p>[For Unwinder Fabric]</p> <ol style="list-style-type: none"> 1. In the local mode, move the dancing bar to the approx. center of the movement range.(Manual feed etc.) 2. Check that the operation mode of the UNWINDER unit is set to Auto. 3. Tap the [DETAIL] button in [SYSTEM ALARM], and tap the [CLEAR ALARM] button. 4. If the alarm appears again even after tapping the [Alarm Clear] button, turn off the power of the built-in PC and then the printer. After a while, turn on the power of the printer and then the PC. 5. If the Alarm appears again, contact your local distributor, our sales office, or service center.

Error No.	Error level	Error displayed	Cause	Measures
F513	0 or 1 or 2	Unwinder Dancer Roll Down Alarm	Dancing bar of the feeding unit has reached its lower limit.	<p>[For Unwinder Paper]</p> <ol style="list-style-type: none"> 1. Level the dancing bar in the local mode. (Manual feed etc.) 2. Check that the operation mode of the UNWINDER unit is set to Auto. 3. Tap the [DETAIL] button in [SYSTEM ALARM], and tap the [CLEAR ALARM] button. 4. If the alarm appears again even after tapping the [Alarm Clear] button, turn off the power of the built-in PC and then the printer. After a while, turn on the power of the printer and then the PC. 5. If the Alarm appears again, contact your local distributor, our sales office, or service center.
				<p>[For Unwinder Fabric]</p> <ol style="list-style-type: none"> 1. In the local mode, move the dancing bar to the approx. center of the movement range.(Manual feed etc.) 2. Check that the operation mode of the UNWINDER unit is set to Auto. 3. Tap the [DETAIL] button in [SYSTEM ALARM], and tap the [CLEAR ALARM] button. 4. If the alarm appears again even after tapping the [Alarm Clear] button, turn off the power of the built-in PC and then the printer. After a while, turn on the power of the printer and then the PC. 5. If the Alarm appears again, contact your local distributor, our sales office, or service center.
F514	2	Unwinder Drive FAULT	UNWINDER unit inverter error	<ol style="list-style-type: none"> 1. Tap the [DETAIL] button in [SYSTEM ALARM], and tap the [CLEAR ALARM] button. 2. If the alarm appears again even after tapping the [Alarm Clear] button, turn off the power of the built-in PC and then the printer. After a while, turn on the power of the printer and then the PC. 3. If the Alarm appears again, contact your local distributor, our sales office, or service center.
F515	3	Unwinder Thermal protection	Malfunction of power supply or breaker of UNWINDER unit	<ol style="list-style-type: none"> 1. Set the operation mode to AUTO on the touch panel of the UNWINDER unit. 2. Tap the [DETAIL] button in [SYSTEM ALARM], and tap the [CLEAR ALARM] button. 3. If the alarm appears again even after tapping the [Alarm Clear] button, turn off the power of the built-in PC and then the printer. After a while, turn on the power of the printer and then the PC. 4. If the Alarm appears again, contact your local distributor, our sales office, or service center.
F516	0	WARNING Unwinder in MANUAL mode	UNWINDER unit is set to manual mode.	<ol style="list-style-type: none"> 1. Set the operation mode to AUTO on the touch panel of the UNWINDER unit. 2. Tap the [DETAIL] button in [SYSTEM ALARM], and tap the [CLEAR ALARM] button. 3. If the alarm appears again even after tapping the [Alarm Clear] button, turn off the power of the built-in PC and then the printer. After a while, turn on the power of the printer and then the PC. 4. If the Alarm appears again, contact your local distributor, our sales office, or service center.

Error No.	Error level	Error displayed	Cause	Measures
F517	3	DRYERJET in Emergency Alarm	Emergency stop occurs in DRYERJET	<ol style="list-style-type: none"> 1. Check the following items. <ol style="list-style-type: none"> (1) Check that the DRYERJET emergency switches (2 places) are released. At this time also check whether the emergency switch on the main unit is released. (2) Make sure that there is no clogging near the media insertion slot of DRYERJET. (3) Check that the area sensor of the DRYERJET is not shielded. (4) Check if all of Dryerjet doors are closed. 2. Tap the [DETAIL] button in [SYSTEM ALARM], and tap the [CLEAR ALARM] button. 3. If the alarm appears again even after tapping the [Alarm Clear] button, turn off the power of the built-in PC and then the printer. After a while, turn on the power of the printer and then the PC. 4. If the Alarm appears again, contact your local distributor, our sales office, or service center.
F518	2	DRYERJET Thermal protection Alarm	DRYERJET's power supply or breaker error	<ol style="list-style-type: none"> 1. Tap the [DETAIL] button in [SYSTEM ALARM], and tap the [CLEAR ALARM] button. 2. If the alarm appears again even after tapping the [Alarm Clear] button, turn off the power of the built-in PC and then the printer. After a while, turn on the power of the printer and then the PC.
F519	2	DRYERJET Inverter Alarm	DRYERJET's inverter error	<ol style="list-style-type: none"> 3. Turn off the power of DRYERJET, wait a while and then turn it on again. 4. If the Alarm appears again, contact your local distributor, our sales office, or service center.
F521	2	Unwinder FC Cardan Alarm	Cardan joint error of Big Roll UNWINDER	<ol style="list-style-type: none"> 1. Check the connection part of the Big Roll Cardan joint. If the cardan joint is not connected to the trolley, connect it. 2. Tap the [DETAIL] button in [SYSTEM ALARM], and tap the [CLEAR ALARM] button. 3. If the alarm appears again even after tapping the [Alarm Clear] button, turn off the power of the built-in PC and then the printer. After a while, turn on the power of the printer and then the PC. 4. If the Alarm appears again, contact your local distributor, our sales office, or service center.
F533	1	Pressing Roller Operated on the Back Side	Pressure roller is operated from the operation panel on the UNWINDER side or the pressure roller switch on the back.	<ol style="list-style-type: none"> 1. After finishing the work you are currently doing, tap the [Details] button of [SYSTEM ALARM] in MPC, and then tap the [Alarm Clear] button. 2. If the alarm appears again even after tapping the [Alarm Clear] button, turn off the power of the built-in PC and then the printer. After a while, turn on the power of the printer and then the PC. 3. If the Alarm appears again, contact your local distributor, our sales office, or service center.
F542	1 or 2	Seam detected alarm	Detected a media seaming at the Small Roll UNWINDER.	<ol style="list-style-type: none"> 1. Check if there is a seam near the Small Roll Seam Detector sensor. If there is a joint, feed the media until the joint comes out of the print area. 2. Tap the [DETAIL] button in [SYSTEM ALARM], and tap the [CLEAR ALARM] button. 3. If the alarm appears again even after tapping the [Alarm Clear] button, turn off the power of the built-in PC and then the printer. After a while, turn on the power of the printer and then the PC. 4. If the Alarm appears again, contact your local distributor, our sales office, or service center.

Error No.	Error level	Error displayed	Cause	Measures
F544	2	DRYERJET Breaking Paper Alarm	Media error on DRYERJET	<ol style="list-style-type: none"> 1. Check the following items. <ol style="list-style-type: none"> (1) Reset the media. (2) Level the tension bar in the local mode. 2. Tap the [DETAIL] button in [SYSTEM ALARM], and tap the [CLEAR ALARM] button. 3. If the alarm appears again even after tapping the [Alarm Clear] button, turn off the power of the built-in PC and then the printer. After a while, turn on the power of the printer and then the PC. 4. If the Alarm appears again, contact your local distributor, our sales office, or service center.
F545	2	DRYERJET Dancer UP Alarm	Dancing bar of the DRYERJET has reached its upper limit.	<ol style="list-style-type: none"> 1. Level the dancing bar in the local. 2. Tap the [DETAIL] button in [SYSTEM ALARM], and tap the [CLEAR ALARM] button.
F546	1 or 2	DRYERJET Dancer DOWN Alarm	Dancing bar of the DRYERJET has reached its lower limit.	<ol style="list-style-type: none"> 3. If the alarm appears again even after tapping the [Alarm Clear] button, turn off the power of the built-in PC and then the printer. After a while, turn on the power of the printer and then the PC. 4. If the Alarm appears again, contact your local distributor, our sales office, or service center.
F547	2	DRYERJET Paper Temperature Alarm	Media temperature error on DRYERJET	<ol style="list-style-type: none"> 1. Check if the heater set temperature is 80 degree C or less.
F548	2	DRYERJET Heating generic Alarm	Heater error on DRYERJET	<ol style="list-style-type: none"> 2. Tap the [DETAIL] button in [SYSTEM ALARM], and tap the [CLEAR ALARM] button. 3. If the alarm appears again even after tapping the [Alarm Clear] button, turn off the power of the built-in PC and then the printer. After a while, turn on the power of the printer and then the PC. 4. If the Alarm appears again, contact your local distributor, our sales office, or service center.
F549	2	By Pass DRYERJET Alarm	Bypass of DRYERJET is enabled by WinGP.	<ol style="list-style-type: none"> 1. Contact your local distributor, our sales office, or service center.
F550	2	DRYERJET Heather Timeout Alarm	The heater operation of DRYERJET timed out.	<ol style="list-style-type: none"> 1. While the printer is waiting, turn off DRYERJET [DRYER] switch. 2. Tap the [DETAIL] button in [SYSTEM ALARM], and tap the [CLEAR ALARM] button. 3. If the alarm appears again even after tapping the [Alarm Clear] button, turn off the power of the built-in PC and then the printer. After a while, turn on the power of the printer and then the PC. 4. If the Alarm appears again, contact your local distributor, our sales office, or service center.

Error No.	Error level	Error displayed	Cause	Measures
F592	0	Unwinder Bypass	The feeding unit is bypassed.	<p>[For Unwinder Paper]</p> <p>It will be displayed if Unwinder bypass is enabled in MPC, so follow the steps below to disable the bypass:</p> <ol style="list-style-type: none"> 1. Disable [MPC] > [Settings] > [Machine] > [Winder - Unwinder] -> [Unwinder Bypass]. 2. Tap the [DETAIL] button in [SYSTEM ALARM], and tap the [CLEAR ALARM] button. 3. If the alarm appears again even after tapping the [Alarm Clear] button, turn off the power of the built-in PC and then the printer. After a while, turn on the power of the printer and then the PC. 4. If the Alarm appears again, contact your local distributor, our sales office, or service center. <p>* If this page is displayed:</p> <ul style="list-style-type: none"> - Unwinder Paper cannot be used. (Cannot operate, does not work) - [Unwinder Disable] is displayed on the operation panel screen. - The following alarm does not occur. (Bypassed) <ul style="list-style-type: none"> • Unwinder Dancer Roll Down • Media End • Unwinder Drive Fault • Warning Unwinder in Manual mode • Unwinder big diameter <p>* The area sensor and emergency switch are still movable even if the Unwinder bypass is enabled.</p>
F592	0	Unwinder Bypass	The feeding unit is bypassed.	<p>[For Unwinder Fabric]</p> <p>It will be displayed if Unwinder bypass is enabled in MPC, so follow the steps below to disable the bypass:</p> <ol style="list-style-type: none"> 1. Disable [MPC] > [Settings] > [Machine] > [Winder - Unwinder] -> [Unwinder Bypass]. 2. Tap the [DETAIL] button in [SYSTEM ALARM], and tap the [CLEAR ALARM] button. 3. If the alarm appears again even after tapping the [Alarm Clear] button, turn off the power of the built-in PC and then the printer. After a while, turn on the power of the printer and then the PC. 4. If the Alarm appears again, contact your local distributor, our sales office, or service center. <p>* If this page is displayed:</p> <ul style="list-style-type: none"> - Unwinder Fabric cannot be used. (Cannot operate, does not work) - [Unwinder Disable] is displayed on the operation panel screen. - The following alarm does not occur. (Bypassed) <ul style="list-style-type: none"> • Unwinder Dancer Roll Up • Unwinder Dancer Roll Down • Media End • Seam detected • Warning Unwinder in Manual mode • Unwinder FC Cardan <p>* The area sensor and emergency switch are still movable even if the Unwinder bypass is enabled.</p>

Error No.	Error level	Error displayed	Cause	Measures
F594	0	Winder Bypass	The Take-up unit is bypassed.	<p>It will be displayed if Winder bypass is enabled in MPC, so follow the steps below to disable the bypass:</p> <ol style="list-style-type: none"> 1. Disable [MPC] > [Settings] > [Machine] > [Winder-Unwinder] -> [Winder Bypass]. 2. Tap the [DETAIL] button in [SYSTEM ALARM], and tap the [CLEAR ALARM] button. 3. If the alarm appears again even after tapping the [Alarm Clear] button, turn off the power of the built-in PC and then the printer. After a while, turn on the power of the printer and then the PC. 4. If the Alarm appears again, contact your local distributor, our sales office, or service center. <p>* If this page is displayed:</p> <ul style="list-style-type: none"> - The automatic operation of the dryerjet paper is disabled. (Manual operation is possible) - The following alarm does not occur. (Bypassed) <ul style="list-style-type: none"> • Unitech Heater Generic Alarm • Dryerjet Dancer Down • Dryerjet Dancer Up • Dryerjet Winder big diameter • Dryerjet Heater Timeout • Dryerjet Breaking Paper <p>* The area sensor and emergency switch are still movable even if the Winder bypass is enabled.</p>
F599	3	Carriage Safety Switch Alarm	Carriage left/right limit switch error	<ol style="list-style-type: none"> 1. Tap the [DETAIL] button in [SYSTEM ALARM], and tap the [CLEAR ALARM] button. 2. If the alarm appears again even after tapping the [Alarm Clear] button, turn off the power of the built-in PC and then the printer. After a while, turn on the power of the printer and then the PC. 3. If the Alarm appears again, contact your local distributor, our sales office, or service center.
F600	2	PLC alarm of Type3	An alarm that requires the print to stop depending on the machine state has occurred. (Type3)	<ol style="list-style-type: none"> 1. Tap the [DETAIL] button in [SYSTEM ALARM], and tap the [CLEAR ALARM] button. 2. If the alarm appears again even after tapping the [Alarm Clear] button, turn off the power of the built-in PC and then the printer. After a while, turn on the power of the printer and then the PC. 3. If the Alarm appears again, contact your local distributor, our sales office, or service center. <p>* This alarm always occurs at the same time as other errors depending on the machine state.</p> <ul style="list-style-type: none"> - If it occurs during printing: <ul style="list-style-type: none"> • The print operation (scan) is stopped. • The carriage returns to parking. • The machine will be in a standby state. - If it occurs during the jog, the jog may be stopped. - If this occurs while the machine is waiting, printing cannot be started.

Error No.	Error level	Error displayed	Cause	Measures
F601	2	PLC alarm of Type4	An alarm that requires the outage and the machine reset depending on the machine state has occurred. (Type4)	<ol style="list-style-type: none"> 1. Tap the [DETAIL] button in [SYSTEM ALARM], and tap the [CLEAR ALARM] button. 2. If the alarm appears again even after tapping the [Alarm Clear] button, turn off the power of the built-in PC and then the printer. After a while, turn on the power of the printer and then the PC. 3. If the Alarm appears again, contact your local distributor, our sales office, or service center. <p>* This alarm always occurs at the same time as other errors under certain conditions.</p> <ul style="list-style-type: none"> - If a Type4 alarm occurs in any machine state: <ul style="list-style-type: none"> • All cycles of the machine are stopped. • Machine is reset. • The carriage returns to parking. • The machine will be in a standby state.
F602	1	PLC alarm of Type2	An alarm that requires the print to stop depending on the machine state has occurred. (Type2)	<ol style="list-style-type: none"> 1. Tap the [DETAIL] button in [SYSTEM ALARM], and tap the [CLEAR ALARM] button. 2. If the alarm appears again even after tapping the [Alarm Clear] button, turn off the power of the built-in PC and then the printer. After a while, turn on the power of the printer and then the PC. 3. If the Alarm appears again, contact your local distributor, our sales office, or service center. <p>* This alarm always occurs at the same time as other errors during printing (it does not occur except during printing).</p> <ul style="list-style-type: none"> - If it occurs during printing: <ul style="list-style-type: none"> • The carriage returns to parking. • The machine will be in a paused state.
F603	3	PLC alarm of Type5	An alarm that requires an emergency stop depending on the machine state has occurred. (Type5)	<ol style="list-style-type: none"> 1. Check the following items. <ol style="list-style-type: none"> (1) Are all 4 emergency switches on the machine released? (2) Are the machine covers (6 places) completely closed? (3) Whether the maintenance cover is completely closed. (4) If you are using an optional unit, confirm that all emergency stop switches on the unit side are released. (5) Whether there is something shading the area sensor. 2. Press the emergency reset switch. 3. Tap the [DETAIL] button in [SYSTEM ALARM], and tap the [CLEAR ALARM] button. 4. Turn off the power of the internal PC and then the main power of the machine in this order, and then turn on again after a while. 5. If the Alarm appears again, contact your local distributor, our sales office, or service center. <p>* An alarm that occurs at the same time when a specific alarm occurs.</p> <ul style="list-style-type: none"> - If a Type5 alarm occurs in any machine state: <ul style="list-style-type: none"> • The machine will make an emergency stop for all cycles. • The machine will be in an emergency-like state. <p>* [SYSTEM]-> [Power]-> [Reset machine] is required.</p>

Error No.	Error level	Error displayed	Cause	Measures
F796	2	Big Roll Unwinder Inverter Alarm	Inverter error of Big Roll UNWINDER	<ol style="list-style-type: none"> 1. Tap the [DETAIL] button in [SYSTEM ALARM], and tap the [CLEAR ALARM] button. 2. If the alarm appears again even after tapping the [Alarm Clear] button, turn off the power of the built-in PC and then the printer. After a while, turn on the power of the printer and then the PC. 3. If the Alarm appears again, contact your local distributor, our sales office, or service center.
FF01	2	PLC Connection Error	PLC AP PLC disconnection occurred	<ol style="list-style-type: none"> 1. Check the LAN cable connection on the back of the internal PC. 2. Tap the [DETAIL] button in [SYSTEM ALARM], and tap the [CLEAR ALARM] button. 3. If the alarm appears again even after tapping the [Alarm Clear] button, turn off the power of the built-in PC and then the printer. After a while, turn on the power of the printer and then the PC. 4. If the Alarm appears again, contact your local distributor, our sales office, or service center.
FF10	0	PLC AP Error Occurred	PLC AP PLC occurred	<ol style="list-style-type: none"> 1. Tap the [DETAIL] button in [SYSTEM ALARM], and tap the [CLEAR ALARM] button.
FF30	0	PLC AP Initialization Failure	PLC AP Initialization failure	<ol style="list-style-type: none"> 2. If the alarm appears again even after tapping the [Alarm Clear] button, turn off the power of the built-in PC and then the printer. After a while, turn on the power of the printer and then the PC.
FF31	0	PLC AP Uninitialization	Processing cannot be continued because PLC AP is not initialized.	<ol style="list-style-type: none"> 3. If the Alarm appears again, contact your local distributor, our sales office, or service center.
FF32	0	PLC AP Failed To Connect	PLC AP Failed to connect	<ol style="list-style-type: none"> 1. Check the LAN cable connection on the back of the internal PC. 2. Tap the [DETAIL] button in [SYSTEM ALARM], and tap the [CLEAR ALARM] button. 3. If the alarm appears again even after tapping the [Alarm Clear] button, turn off the power of the built-in PC and then the printer. After a while, turn on the power of the printer and then the PC. 4. If the Alarm appears again, contact your local distributor, our sales office, or service center.

Error list (Analysis Application “NZCApp”)

Error No.	Message	Error description Cause	Corrective action Solution
4610	No indication	Abnormal pattern analysis	<ol style="list-style-type: none"> 1. Execute cleaning to improve the firing condition. 2. Set the pattern correctly and scan the scanner. 3. Check the scanner for dirt on the reading surface.
4611	No indication		
4612	No indication		
4614	No indication		
4615	No indication		
4616	No indication		
4617	No indication		
4618	No indication		
4619	No indication		
4620	No indication		
No number	ErrorInclination="Inclination detection error."		
No number	ErrorFile="Could not open file."	Image file reading loading error	<ol style="list-style-type: none"> 1. Check that there are files loaded by the scanner. 2. Scan the pattern again and select the file.
No number	ErrorMatch="Incorrect file."	Image file error	<ol style="list-style-type: none"> 1. Make sure that the files captured loaded by the scanner are in BMP format. 2. Scan the pattern again and select the file.
No number	ErrorMemImage="Image memory error."	Internal processing error	<p>Restart the PC. If it appears again, contact your local distributor, our sales office, or service center.</p>
No number	ErrorMemWork="Work memory error."		
No number	ErrorMemLayer="Layer memory error."		
No number	ErrorSaveFile="Could not save file."		
No number	ErrorSavePath="Invalid path."	Setting file error	<p>Restart the nozzle analysis application. If it appears again, contact your local distributor, our sales office, or service center.</p>
No number	ErrorOffset="Offset error."		
No number	ErrorOffB="OffsetB error."		
No number	ErrorINI="parameter %s is invalid."		

Error list (Other)

Error No.	Error level	Error displayed	Cause	Measures	
CPU					
1	04	2	0104:YY(_____) +35V RECVR	An error occurred in the control PCB.	Turn off the power of the internal PC and then the main power of the machine in this order, and then turn on again after a while. If it appears again, contact your local distributor, our sales office, or service center.
1	0E	2	010E:YY(_____) FROM CLEAR		
1	0F	2	010F:YY(_____) FROM WRITE		
1	1F	2	011F:YY(_____) PCB SLIDER		
1	15	2	0115:YY(_____) PCB MAIN-F1		
1	16	2	0116:YY(_____) PCB MAIN-F2		
1	22	2	0122:YY(_____) CHECK :SDRAM		
1	23	2	0123:YY(_____) PRAM DATA		
1	24	2	0124:YY(_____) PRAM ADDR		
1	27	2	0127:YY(_____) POWER OFF		
1	28	2	0128:YY(_____) ZZ) HDC FIFO OVER ZZ indicates a head number. 1 : Head 1 (rear) 2 : Head 2 (front)	Detected battery running out of internal clock.	Contact your local distributor, our sales office, or service center.
1	28	2	0128:YY(_____) ZZ) HDC FIFO UNDER ZZ indicates a head number. 1 : Head 1 (rear) 2 : Head 2 (front)		
1	29	2	0129:YY(_____) BATTERY EXCHANGE	Head heater power fuse blown.	Contact your local distributor, our sales office, or service center.
1	2A	2	012A:YY(_____) ZZ) HD HEATER FUSE ZZ indicates a head number. 1 : Head 1 (rear) 2 : Head 2 (front)		
1	2D	2	012D:YY(_____) PCB MAIN-F4	The fuse on the main PCB has blown.	An error has occurred in the power supply.
1	51	2	0151:YY(_____) Main PCB V1R2		
1	52	2	0152:YY(_____) Main PCB V2R5		
1	53	2	0153:YY(_____) Main PCB V3R3		
1	54	2	0154:YY(_____) Main PCB V05		
1	55	2	0155:YY(_____) Main PCB V36-1		
1	56	2	0156:YY(_____) Main PCB V5B		
1	57	2	0157:YY(_____) Main PCB VTT		
1	58	2	0158:YY(_____) Main PCB V36-2		
1	6E	2	016E:YY(_____) Main PCB V3R3B		
1	71	2	0171:YY(_____) ZZ) NEW HEAD CONNECT ZZ indicates a head number. 1 : Head 1 (rear) 2 : Head 2 (front)	Recognized a new head connection.	Turn off the power of the internal PC and then the main power of the machine in this order, and then turn on again after a while. If it appears again, contact your local distributor, our sales office, or service center.
1	72	2	0172:YY(_____) Main PCB Q6 Check	An error has occurred in the power supply.	
1	8A	2	018A:YY(_____) Main PCB V_CORE		
1	8B	2	018B:YY(_____) Main PCB V1R5B		
1	8C	2	018C:YY(_____) Main PCB V12		

Error No.	Error level	Error displayed	Cause	Measures	
1	8E	2	018E:YY(_____)ZZ)FLS NOT COMP ZZ indicates a head number. 1 : Head 1 (rear) 2 : Head 2 (front)	Ink ejection control error	Turn off the power of the internal PC and then the main power of the machine in this order, and then turn on again after a while. If it appears again, contact your local distributor, our sales office, or service center.
1	8F	2	018F:YY(_____)ZZ)OFFSET START ZZ indicates a head number. 1 : Head 1 (rear) 2 : Head 2 (front)		
1	90	0	0190:YY(_____)Main PCB V_V1	An error has occurred in the power supply.	
1	9E	2	019E:YY(_____)HDC*-F1	The fuse on the head has blown.	
1	BF	2	01BF:YY(_____)PCB MAIN-F2/F3	The fuse on the main PCB has blown.	
1	E7	2	01E7:09(_____)PCB INKCTRL1	An error occurred in the control PCB.	
1	E8	2	01E8:09(_____)PCB INKCTRL2		
1	EB	2	01EB:09(_____)PCB BIO		
Command					
2	01	1	0201:YY(_____)COMMAND	Communication error between PC and printer	Turn off the power of the internal PC and then the main power of the machine in this order, and then turn on again after a while. If it appears again, contact your local distributor, our sales office, or service center.
2	02	1	0202:YY(_____)PARAMETER		
2	03	2	0203:YY(_____)Ment Command		
Communication					
3	0C	2	030C:YY(_____)SCAN DATA TIMEOUT	Communication error between PC and printer	Turn off the power of the internal PC and then the main power of the machine in this order, and then turn on again after a while. If it appears again, contact your local distributor, our sales office, or service center.
Sensor					
5	09	2	0509:YY(_____)HDC POSCNT	HDC position counter error occurred. An error occurred in the linear scale or Y motor.	Turn off the power of the internal PC and then the main power of the machine in this order, and then turn on again after a while. If it appears again, contact your local distributor, our sales office, or service center.
5	19	2	0519:09(_____)NEGATIVE PRESS SENSOR	Negative pressure sensor error	
5	1A	2	051A:09(_____)POSITIVE PRESS SENSOR	Positive pressure sensor error	

Error No.	Error level	Error displayed	Cause	Measures	
5	31	2	0531:09(ZZZZZZZZ)INKTANK SENSOR ZZZZZZZZ indicates a path number. 1 : Path 1 2 : Path 2 : 8 : Path 8	Error in the balance of the ink supply unit	Check that the ink tank is correctly set, that there is no impact, and that there is no load. Turn off the power of the internal PC and then the main power of the machine in this order, and then turn on again after a while. If the problem persists even after performing the above operations, contact your local distributor, our sales office, or service center.
5	4A	2	054A:YY(_____)PDC POSINT:1234	PDC position interrupt does not occur. An error occurred in the linear scale or Y motor.	Turn off the power of the internal PC and then the main power of the machine in this order, and then turn on again after a while. If it appears again, contact your local distributor, our sales office, or service center.
Ink					
6	01	0	0601:09(ZZZZZZZZ)INK NEAR END ZZZZZZZZ indicates a path number. 1 : Path 1 2 : Path 2 : 8 : Path 8	Ink in the ink tank is low.	Ink is low. Replace it with a new ink tank according to the following procedure. 1. Pull out the tank tray. 2. Replace with a new ink tank. 3. Return the tank tray. 4. Execute [CLEAR ALARM].
6	02	1	0602:09(ZZZZZZZZ)INK END ZZZZZZZZ indicates a path number. 1 : Path 1 2 : Path 2 : 8 : Path 8	Ink in the ink tank is run out.	1. Pull out the tank tray. 2. Replace with a new ink tank. 3. Return the tank tray. 4. Execute [CLEAR ALARM].
6	03	1	0603:09(ZZZZZZZZ)INK TANK SET ZZZZZZZZ indicates a path number. 1 : Path 1 2 : Path 2 : 8 : Path 8	Ink tank is not detected.	Follow the steps below to set the ink tank. 1. Pull out the tank tray. 2. Set the ink tank. 3. Return the tank tray. 4. Execute [CLEAR ALARM]. If the above does not solve the problem, contact your local distributor, our sales office, or service center.
6	17	2	0617:09(ZZZZZZZZ)WRONG SUBTANK SENSOR ZZZZZZZZ indicates a path number. 1 : Path 1 2 : Path 2 : 8 : Path 8	Detected an abnormality of the sub-tank liquid level sensor.	Turn off the power of the internal PC and then the main power of the machine in this order, and then turn on again after a while. If it appears again, contact your local distributor, our sales office, or service center.

Error No.	Error level	Error displayed	Cause	Measures	
6	1A	2	061A:09(ZZZZZZZZ)INK OVERFLOW ZZZZZZZZ indicates a path number. 1 : Path 1 2 : Path 2 : 8 : Path 8	Detected sub-tank sensor Limit.	Air may have been aspirated. Check the remaining ink level in the ink tank and execute [CLEAR ALARM]. If the Alarm appears again, contact your local distributor, our sales office, or service center.
6	1B	2	061B:09(ZZZZZZZZ)INK SUPPLY ZZZZZZZZ indicates a path number. 1 : Path 1 2 : Path 2 : 8 : Path 8	Ink can not be supplied to the sub-tank.	Check the remaining ink level in the ink tank and execute [CLEAR ALARM]. If the Alarm appears again, contact your local distributor, our sales office, or service center.
6	1C	2	061C:09(_____)NEGATIVE PRESS CONTROL	Abnormal start of negative pressure control	Turn off the power of the internal PC and then the main power of the machine in this order, and then turn on again after a while. If it appears again, contact your local distributor, our sales office, or service center.
6	1D	2	061D:09(_____)NEGATIVE PRESS NOT ENOUGH	The proper range of negative pressure can not be maintained.	
6	1E	2	061E:09(_____)NEGATIVE PRESS OVER		
6	1F	2	061F:09(_____)POSITIVE PRESS CONTROL	Abnormal start of positive pressure control	
6	20	2	0620:09(_____)POSITIVE PRESS NOT ENOUGH	The proper range of positive pressure can not be maintained.	
6	21	2	0621:09(_____)POSITIVE PRESS OVER		
6	37	2	0637:09(_____)ZZ)INK LEAK ZZ indicates an ink leak sensor. 1 : Supply unit right side Ink leak Sensor 2 : Supply unit left side Ink leak sensor	Ink leakage occurred near the ink tank.	
6	5D	2	065D:09(_____)ZZ)Overflownk ZZ indicates the chamber bottle. 1 : Chamber bottles for paths 1 to 4 2 : Chamber bottles for paths 5 to 8	Ink has entered the air tank.	
6	6B	2	066B:09(ZZZZZZZZ)SUBTANK EMPTY ZZZZZZZZ indicates a path number. 1 : Path 1 2 : Path 2 : 8 : Path 8	There is no ink in the sub-tank.	Check the remaining ink level in the ink tank and execute [CLEAR ALARM]. If the Alarm appears again, contact your local distributor, our sales office, or service center.
6	6D	1	066D:09(_____)1)INKTANK PULL OUT	Ink tank tray is pulled out.	Return the ink tank tray. Execute [CLEAR ALARM] after returning the ink tank tray.
6	77	0	0677:09(_____)DEGAS CONTROL	An abnormality was detected in the degassing control.	Turn off the power of the internal PC and then the main power of the machine in this order, and then turn on again after a while. If it appears again, contact your local distributor, our sales office, or service center.

Error No.	Error level	Error displayed	Cause	Measures	
6	78	0	0678:09(ZZZZZZZZ)INK CIRCULATION WARN ZZZZZZZZ indicates a path number. 1: Route 1 2: Route 2 : 8: Route 8	An abnormality was detected in the ink circulation control.	Make sure that the fitting of the tube connected to the ink tank is securely connected, and then perform [CLEAR ALARM]. If the Alarm appears again, contact your local distributor, our sales office, or service center.
6	7D	0	067D:09(ZZZZZZZZ)INK SUPPLY WARN ZZZZZZZZ Indicates the route number. 1: Route 1 2: Route 2 : 8: Route 8	An error has been detected in the ink supply status. The supply filter may be starting to clog.	Check the remaining ink level in the ink tank and execute [CLEAR ALARM]. If the Alarm appears again, contact your local distributor, our sales office, or service center.
Heater					
7	3E	2	073E:YY(____ZZ)HD HEATER BREAK ZZ indicates a head number. 1 : Head 1 (rear) 2 : Head 2 (front)	The head heater is disconnected.	Turn off the power of the internal PC and then the main power of the machine in this order, and then turn on again after a while. If it appears again, contact your local distributor, our sales office, or service center.
7	3F	2	073F:YY(____ZZ)HD HEATER CTRL ERR ZZ indicates a head number. 1 : Head 1 (rear) 2 : Head 2 (front)	The head heater cannot be controlled.	
7	40	2	0740:YY(____ZZ)HD HEATER TEMP HIGH ZZ indicates a head number. 1 : Head 1 (rear) 2 : Head 2 (front)	The head heater temperature is high	
FW					
1	1F	2	011F:YY(____)PCB SLIDER	An error occurred in the control PCB.	Turn off the power of the internal PC and then the main power of the machine in this order, and then turn on again after a while. If it appears again, contact your local distributor, our sales office, or service center.
1	90	0	0190:YY(____)Main PCB V_V1	An error has occurred in the power supply.	
1	E7	2	01E7:09(____)PCB INKCTRL1	An error occurred in the control PCB.	
1	E8	2	01E8:09(____)PCB INKCTRL2		
1	EB	2	01EB:09(____)PCB BIO		
6	78	0	0678:09(ZZZZZZZZ)INK CIRCULATION WARN ZZZZZZZZ indicates a path number. 1: Route 1 2: Route 2 : 8: Route 8	An abnormality was detected in the ink circulation control.	Make sure that the fitting of the tube connected to the ink tank is securely connected, and then perform [CLEAR ALARM]. If the Alarm appears again, contact your local distributor, our sales office, or service center.
6	7D	0	067D:09(ZZZZZZZZ)INK SUPPLY WARN ZZZZZZZZ Indicates the route number. 1: Route 1 2: Route 2 : 8: Route 8	An error has been detected in the ink supply status. The supply filter may be starting to clog.	Check the remaining ink level in the ink tank and execute [CLEAR ALARM]. If the Alarm appears again, contact your local distributor, our sales office, or service center.

Error No.	Error level	Error displayed	Cause	Measures	
8	01	2	0801:YY(____)(C)OPCODE	An error occurred in the control PCB.	Turn off the power of the internal PC and then the main power of the machine in this order, and then turn on again after a while. If it appears again, contact your local distributor, our sales office, or service center.
8	02	2	0802:YY(____)(C)SWI		
8	03	2	0803:YY(____)(C)PFTCH ABRT		
8	04	2	0804:YY(____)(C)DATA ABRT		
8	06	2	0806:YY(____)FW/SIO bit		
8	07	2	0807:YY(____)FW/SIO wbsy		
8	0E	2	080E:YY(____)FW/FROM prm		
8	0F	2	080F:YY(____)FW/SIO vch		
8	11	2	0811:YY(____)FW/SIO read		
8	15	2	0815:YY(____)FW/SIO rsrc		
8	16	2	0816:YY(____)FW/FROM WRC		
8	17	2	0817:YY(____)FW/SaveArea		
8	1B	2	081B:YY(____)FW/STACK OV		
8	26	2	0826:YY(____)FW/PrmSaveBuf		
8	28	2	0828:YY(ZZZZZZZ)PRG ERR L***** Z indicates the program address where the error occurred.		
8	29	2	0829:YY(____)FW/ERASE TIMEOV	Control data is not registered / invalid (Tiger).	Turn off the power of the internal PC and then the main power of the machine in this order, and then turn on again after a while. If it appears again, contact your local distributor, our sales office, or service center.
8	3A	2	083A:YY(ZZZZZZZ)PARAMETER ERROR ZZZZZZZZ indicates the control data number (information for developers).		
User					
9	16	2	0916:YY(____)ROM MISSMATCH	-	Make sure that the ROM is for the target model. If the error occurs in the target model ROM, contact your local distributor, our sales office, or service center.

Error No.	Error level	Error displayed	Cause	Measures
CPU2				
B 25	2	0B25:YY(____)HDC DIRECTION	Scan control error	Turn off the power of the internal PC and then the main power of the machine in this order, and then turn on again after a while. If it appears again, contact your local distributor, our sales office, or service center.
B 27	2	0B27:YY(____)HD LOGIC FUSE	Print head control PCB error	
B 28	2	0B28:YY(____)HD DRIVER FUSE		
B 29	2	0B29:YY(____)HD VLT ERR		
B 2A	2	0B2A:YY(____ZZ)HD HEATER FUSE		
B 35	2	0B35:YY(____ZZ)HD VLT ERR ZZ indicates a head number. 1 : Head 1 (rear) 2 : Head 2 (front)	HD driver voltage 26V abnormal	
B 38	2	0B38:YY(____ZZ)HD DRV V26 ZZ indicates a head number. 1 : Head 1 (rear) 2 : Head 2 (front)	HD driver voltage 26V ± 5% error	
B 3E	2	0B3E:09(ZZZZZZZ)PCB LOADCELL AD ZZZZZZZZ indicates a path number. 1 : Path 1 2 : Path 2 : 8 : Path 8	Load cell AD PCB error	
Head				
D 0B	2	0D0B:YY(____ZZ)HD CONNECT ZZ indicates a head number. 1 : Head 1 (rear) 2 : Head 2 (front)	Head connection error	Turn off the power of the internal PC and then the main power of the machine in this order, and then turn on again after a while. If it appears again, contact your local distributor, our sales office, or service center.
D 0C	2	0D0C:YY(____ZZ)HD THERMIS ZZ indicates a head number. 1 : Head 1 (rear) 2 : Head 2 (front)	Head temperature error The head temperature specified in the head connection check is an invalid value.	
D 0D	2	0D0D:YY(____)HDC SPEED	Head control error	
D 1C	2	0D1C:YY(____ZZ)HD BUSY ZZ indicates a head number. 1 : Head 1 (rear) 2 : Head 2 (front)	Cannot communicate with the print head.	
D 1D	2	0D1D:YY(____ZZ)HD CMD ZZ indicates a head number. 1 : Head 1 (rear) 2 : Head 2 (front)		
D 1E	2	0D1E:YY(____ZZ)HD DRIVE HOT ZZ indicates a head number. 1 : Head 1 (rear) 2 : Head 2 (front)	The print head detected a temperature error.	Turn off the power of the internal PC and then the main power of the machine in this order, and then turn on again after a while. If it appears again, contact your local distributor, our sales office, or service center.











Error No.	Error level	Error displayed	Cause	Measures
MDC Mode_Error				
C0	51	0	C051:00(ZZZZZZZ)PRINT MODE ERROR(1)	Turn off the power of the internal PC and then the main power of the machine in this order, and then turn on again after a while. If it appears again, contact your local distributor, our sales office, or service center.
C0	52	0	C052:00(ZZZZZZZ)PRINT MODE ERROR(2)	
C0	53	0	C053:00(ZZZZZZZ)PRINT MODE ERROR(3)	
C0	54	0	C054:00(ZZZZZZZ)PRINT MODE ERROR(4)	
C0	55	0	C055:00(ZZZZZZZ)PRINT MODE ERROR(5)	
MDC Processing Error				
CC	10	0	CC10:00(ZZZZZZZ)Auto Cleaning Failure	Cleaning cannot be performed, or an error occurred during cleaning. Please check the following. <ol style="list-style-type: none"> 1. Carriage is not in parking position 2. Ink supply system error occurred during cleaning 3. Clear all the errors that have occurred.
CC	11	0	CC11:00(ZZZZZZZ)Auto Flushing Failure	
MDC Connection_Error				
C1	01	0	C101:00(ZZZZZZZ)Command Format ERROR	Turn off the power of the internal PC and then the main power of this unit, check the connection status of the LAN cable on the back of the internal PC, and then turn on the power again. If it appears again, contact your local distributor, our sales office, or service center.
C1	02	0	C102:00(ZZZZZZZ)Notify receive ERROR ZZZZZZZ indicates the command code (information for developers).	
C1	03	0	C103:00(ZZZZZZZ)Respons receive ERROR ZZZZZZZ indicates the command code (information for developers).	
C1	04	0	C104:00(ZZZZZZZ)Parameter read ERROR(1)	
C1	05	0	C105:00(ZZZZZZZ)Parameter read ERROR(2)	
C1	06	0	C106:00(ZZZZZZZ)Respons set ERROR	
C1	07	0	C107:00(ZZZZZZZ)Notice Respons ERROR ZZZZZZZ indicates the command code (information for developers).	
C1	10	2	C110:00(ZZZZZZZ)Communication ERROR(MDL)	
C1	11	2	C111:00(ZZZZZZZ)Communication ERROR(MRL)	

Error No.	Error level	Error displayed	Cause	Measures	
MDC Command_Error					
C2	01	0	C201:00(ZZZZZZZZ)MG Command ERROR	Received undefined MG command	Turn off the power of the internal PC and then the main power of the machine in this order, and then turn on again after a while. If it appears again, contact your local distributor, our sales office, or service center.
MDC Print_Error					
C3	01	2	C301:00(ZZZZZZZZ)File read ERROR	Cannot read the specified file.	Turn off the power of the internal PC and then the main power of the machine in this order, and then turn on again after a while. If it appears again, contact your local distributor, our sales office, or service center.
C3	02	0	C302:00(ZZZZZZZZ)Parameter is not set	Operating parameter does not exist.	
C3	03	0	C303:00(ZZZZZZZZ)Parameter illegal ERROR	Invalid operation parameter	
C3	04	2	C304:00(ZZZZZZZZ)TIFF read ERROR	TIFF file reading failure	Data created with RIP software may be corrupted. Check the output target model and printing conditions, and create the data again.
C3	05	2	C305:00(ZZZZZZZZ)Mask ERROR	Mask creation failure	
C3	06	2	C306:00(ZZZZZZZZ)PSTUS file read ERROR	Invalid print condition value	
MDC Prm_Error					
C4	01	2	C401:00(ZZZZZZZZ)Control Data read ERROR	Error reading control data	Turn off the power of the internal PC and then the main power of the machine in this order, and then turn on again after a while. If it appears again, contact your local distributor, our sales office, or service center.
C4	02	2	C402:00(ZZZZZZZZ)Control Data download ERROR	Control data download error	
MDC Config_Error					
C8	01	2	C801:00(Z)Target does not exist Z indicates the number of the Firmware that could not be detected. 1 ~ 8 : PEFW 9 : IOFW	Target does not exist.	The machine settings are not correct. Contact your local distributor, our sales office, or service center.
C8	02	2	C802:00(Z)PCB composition ERROR Z indicates the configuration error Firmware number. 1 ~ 8 : PEFW 9 : IOFW	Machine configuration error	
C8	03	2	C803:00(ZZZZZZZZ)Version ERROR	Version error	The version of the units that configures this machine is incorrect. Contact your local distributor, our sales office, or service center.

Error No.	Error level	Error displayed	Cause	Measures
MDC System_Error				
C9	01	2	C901:00(ZZZZZZZZ)Program ERROR	Turn off the power of the internal PC and then the main power of the machine in this order, and then turn on again after a while. If it appears again, contact your local distributor, our sales office, or service center.
C9	98	2	C998:00(ZZZZZZZZ)EXCEPTION(1)	
C9	99	2	C999:00(ZZZZZZZZ)EXCEPTION(2)	
MDC FW_Error				
CA	01	2	CA01:00(ZZZZZZZZ)Calibration Value is Not Stable	The AD value during calibration is not stable for a certain period of time.
F5	33	1	Pressing Roller Operated on the Back Side	The pressure roller is operated from the operation panel on the Unwinder side or from the pressure roller switch on the back. <ol style="list-style-type: none"> 1. After finishing the work you are currently doing, tap the [Details] button of [SYSTEM ALARM] in MPC, and then tap the [Alarm Clear] button. 2. . If the alarm is displayed again after tapping the [Alarm Clear] button, turn off the power of the built-in PC and then the printer. After a while, turn on the power of the printer and then the PC 3. If the alarm still appears even after performing [Alarm Clear], contact your local distributor, our sales office, or the service center.

Dismantling

To move this machine to another location during the service life of it, proceed as follows:

Procedure		Dismantling			
S	Mode	Key	Indication	Feature	Reference
1				Turn off the machine and disconnect from all power sources.	
2				Clean the machine and protect the parts subject to corrosion, using appropriate products.	
3				For transporting and installing to a new location, follow the means and methods described in this manual.	
4				Use lubricant or grease in this machine. Use an approved degradable solvent to neutralize unrepairable lubricant adhering to parts of this machine.	
5				Move recoverable waste oil to an empty tank and consign it to a waste oil processing company.	
6				Properly dispose of any batteries, accumulators, battery of the electronic boards and conditioner that may be present on the machine.	
7				Once the machine reaches its end of the service life, it must be taken out of service as it cannot be used for the purposes for which it was designed and built; however, its parts and raw materials are reusable.	
8				However, such reuse shall be subject to conditions and functions different from the design and construction of individual parts and the entire machine.	
9				Mimaki assumes no responsibility for injury or property damage caused by reuse of each part of this machine in a function different from the original one or the assembling situation.	
10				Mimaki will not approve the adaptability of the parts to be reused after the final removal of this machine, either explicitly or implicitly.	
End of procedure					

ML Tiger-1800B MK III Operation Manual

March 2021

MIMAKI ENGINEERING CO.,LTD.

2182-3 Shigeno-otsu, Tomi-shi, Nagano 389-0512 JAPAN

D203491-11-25032021



IG
MM