

# Safety Precautions

## UV INKJET PRINTER *JFX200-2513 EX*

### Safety Precautions

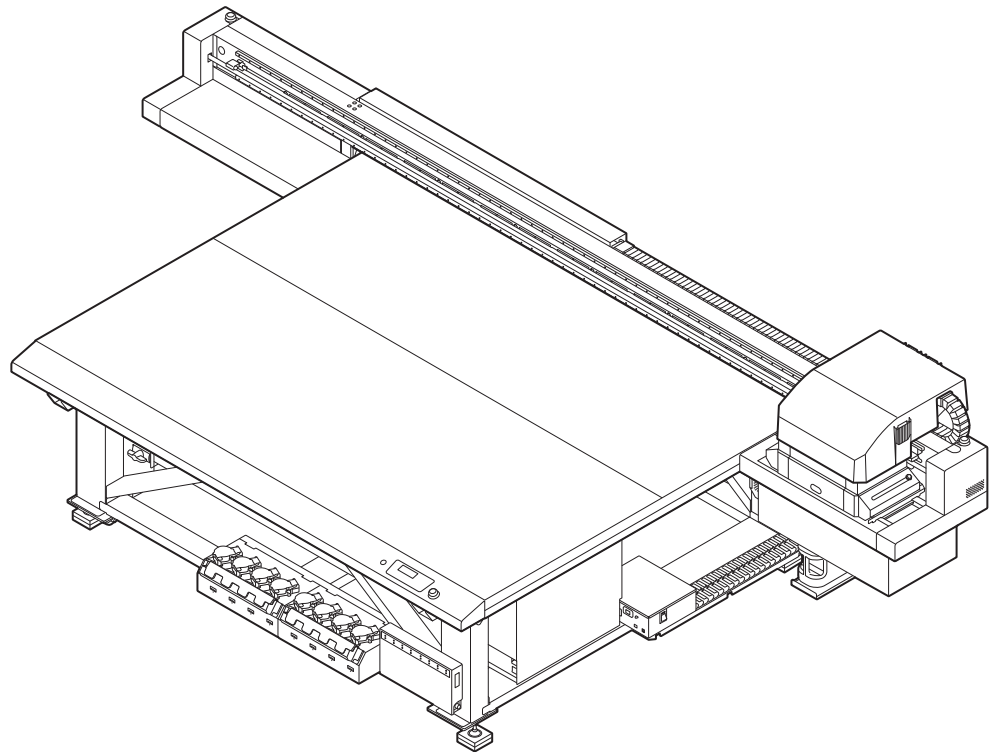

You can also download the latest manual from official website.

MIMAKI ENGINEERING CO., LTD.

<https://mimaki.com/>

D203453-11  
Original instructions

# TABLE OF CONTENTS

---

Introduction .....	3
For safe use .....	5
Symbols .....	5
Usage Warnings and Precautions .....	6
Cautions on Installation .....	12
Warning Labels .....	13
1. Usage Restrictions.....	16
Usage Restrictions.....	16
User Restrictions .....	16
Area Restrictions .....	16
2. Avoid These While Operating the Printer .....	17
Confirmation for agreement.....	23

# Introduction

Congratulations on your purchase of UV inkjet printer JFX200-2513EX.

JFX200-2513EX is a Large Flatbed UV Inkjet Printer that supports high speed and high image quality, printing with UV ink.

## ● DISCLAIMER OF WARRANTY

THIS LIMITED WARRANTY OF MIMAKI SHALL BE THE SOLE AND EXCLUSIVE WARRANTY AND IS IN LIEU OF ALL OTHER WARRANTIES, EXPRESS OR IMPLIED, INCLUDING, BUT NOT LIMITED TO, ANY IMPLIED WARRANTY OF MERCHANTABILITY OR FITNESS.

AND MIMAKI NEITHER ASSUMES NOR AUTHORIZES DEALER TO ASSUME FOR IT ANY OTHER OBLIGATION OR LIABILITY OR MAKE ANY OTHER WARRANTY OR MAKE ANY OTHER WARRANTY IN CONNECTION WITH ANY PRODUCT WITHOUT MIMAKI'S PRIOR WRITTEN CONSENT.

IN NO EVENT SHALL MIMAKI BE LIABLE FOR SPECIAL, INCIDENTAL OR CONSEQUENTIAL DAMAGES OR FOR LOSS OF PROFITS OF DEALER OR CUSTOMERS OF ANY PRODUCT.

## ● Requests

- This Operation Manual explains how to operate and maintain "UV inkjet printer JFX200-2513EX" (hereafter called "this machine").
- Please read and fully understand this Operation Manual before using the printer. It is also necessary to keep this Operation Manual in an easy to reach location.
- Make arrangements to deliver this Operation Manual to the person in charge of the operation of this printer.
- This Operation Manual has been carefully prepared for your easy understanding. However, if you have any inquiries, contact your local distributor, our sales office, or service center.
- The contents of this Operation Manual are subject to change for improvement without notice.
- In the case where this Operation Manual should be illegible due to destruction or breakage, contact our sales office.
- You can also download the latest manual from our website.

## ● FCC Statement (USA)

This equipment has been tested and found to comply with the limits for a Class A ITE, pursuant to Part 15 of the FCC Rules. These limits are designed to provide reasonable protection against harmful interference when the equipment is operated in a commercial environment.

This equipment generates, uses and can radiate radio frequency energy and, if not installed and used in accordance with the operation manual, may cause harmful interference to radio communications.

Operation of this equipment in a residential area is likely to cause harmful interference in which case the user will be required to correct the interference at his/her own expense.



- In the case where MIMAKI-recommended cable is not used for connection of this machine, limits provided by FCC rules can be exceeded.  
To prevent this, use of MIMAKI-recommended cable is essential for the connection of this machine.
- 

## ● Interference to televisions and radios

The printer described in this manual generates low radio waves while it is in operation. This printer can interfere with the reception of radios and televisions if set up or used under improper conditions. This printer is not guaranteed against any damage to specific-purpose radios and televisions.

If you feel that this printer might be causing reception interference with your radio or television, check by turning the power switch on and off. If the interference disappears when the power is turned off, this product is likely to be the cause of the interference.

Try any of the following solutions or combinations of these solutions:

- Change the orientation of the TV or radio antenna to find a position where interference does not occur.
- Move the TV or radio away from this product.
- Plug the TV or radio into a power outlet on a different power circuit to this product.

Reproduction of this manual is strictly prohibited. All Rights Reserved.











© 2019 MIMAKI ENGINEERING Co., Ltd.

# For safe use

## Symbols

In this document, symbols are used for explaining the contents of cautions on operation. The symbol to be displayed differs depending on the caution content. Please understand the meaning of each symbol and use this machine safely and correctly.

### ● Examples of symbols

Meaning		
 <b>WARNING</b>	WARNING	Failure to observe the instructions given with this symbol can result in death or serious injuries to personnel. Be sure to read it carefully and use the printer properly.
 <b>CAUTION</b>	CAUTION	Failure to observe the instructions given with this symbol can result in minor or medium injuries to personnel.
	GENERAL WARNING	This symbol indicates that the items shown need to be noted. Specific notes are drawn in the figure  .
	GENERAL MANDATORY ACTION	This symbol indicates that the action shown must be executed. Specific instruction is drawn in the figure  .
	GENERAL PROHIBITION	This symbol indicates that the action shown is prohibited. Specific action that is prohibited is drawn in the figure  .
 <b>Important!</b>	IMPORTANT	Important notes for the use of this printer are given with this symbol. Understand the notes thoroughly to operate the printer properly.
	HINT	Useful information is given with this symbol. Understand the notes thoroughly to operate the printer properly.
	REFERENCE	This symbol indicates the reference page for related contents. Click the text to display the corresponding page.

## Usage Warnings and Precautions

### ● In the event of abnormal conditions

#### WARNING



- If someone swallows ink or cleaning solution by mistake, keep him or her quiet and take them to see a doctor immediately. Do not let allow the person to swallow the vomit.
- If you inhale a great deal of vapor and feel ill, immediately move to a location with plenty of fresh air, and keep yourself warm and quiet. Consult a doctor as soon as possible.
- In the unlikely event that a foreign object such as metal, water, liquid enters the inside of this machine, turn off the power immediately. Afterwards be sure to unplug the power plug from the outlet. If used as it is, it may cause fire or electric shock.
- If ink leaks, turn off the main power switch and unplug the power cable. After that, contact your local distributor, our sales office, or service center.



- Immediately turn off the main power supply and disconnect the power cable from the machine if a problem such as an abnormal smell, smoke, or sign of spark occurrence is detected in the machine. If used as it is, it may cause fire or electric shock. Check first that the machine no longer produces smoke, and contact your distributor or a sales office of MIMAKI for repair.
- Never repair your printer by yourself since it is very dangerous to do so.

### ● Handling of ink and cleaning solution

#### WARNING



- Make sure to read the Safety Data Sheet (SDS) before handling ink and washing liquid.
- Some constituents are toxic to aquatic life. Prevent leakage into natural water systems or domestic wastewater.
- If ink adheres to the skin or clothing, immediately rinse with soap and water. If you get the ink in your eyes, wash them immediately with water and consult a doctor.
- Discard the waste ink according to the local regulations of the area where this printer is used.
- Be sure to store the ink and cleaning solution in a cold dark location. Store the cleaning solution in a location that is out of the reach of children.



- When handling ink and washing liquid, pay close attention to ventilation and be sure to wear the included safety glasses and gloves. The ink or washing liquid may get in your eyes.



#### CAUTION



- Use of ink other than that specified will damage this printer. Malfunctions caused due to the use of alternative ink are out of the scope of warranty. Please understand that the cost of repairs in this case is to be borne by the customer.
- Never refill an ink bottle with ink. Malfunctions caused due to refilling of the ink bottle are out of the scope of warranty, and our company does not assume any responsibility for the same.
- Do not use the ink designed for this printer with other printers. Doing so may cause damage to the printer.

### ● Handling of ink bottles

#### WARNING



- Precautions regarding ink are indicated on the Ink bottle. Read these carefully and make sure you understand the contents before using the product.
- Store ink bottles and the waste ink tank in a location that is out of the reach of children.

### CAUTION



- If the ink bottle is moved from a cold to a warm place, leave it for more than 3 hours before use.
- Open the ink bottle just before use and be sure to use it promptly. If the bottles are left open for a long time, the printing quality may degrade.
- For device protection, do not use any ink other than the dedicated ink.



- Do not strike the ink bottle with great force nor shake it violently. Doing so may cause ink to leak out of the bottle.

## ● Be Careful with Moving Parts

### WARNING



- Do not place your fingers or other parts of body close to dangerous moving parts. There is a danger of injury.

## ● Warning Labels

### CAUTION



- Warning labels are affixed to this printer. Be sure to fully understand the warnings indicated on the labels. If any of the warning labels has become so soiled that the warning message is illegible or has come off, purchase a new one from your local distributor.

## ● Ultraviolet Rays (UV), UV-LED

### WARNING



- The LED UV unit becomes hot inside. Turn off the LED UV unit and perform maintenance once the device cools down adequately. It may cause burns.



- A small amount of UV light leaks out around the LED UV unit. Wear gloves, long-sleeved clothes, light-shielding mask, light-shielding glasses, and similar protection so that your skin and eyes will not be exposed to UV light.

(1) Direct exposure of skin or eyes to UV light may result in inflammation or skin cancer.

(2) Even if UV light is weak and not likely to cause inflammation, repeated exposure to it may result in a chronic disease.

(3) Viewing a lit UV lamp with the naked eye may cause eye pain or visual impairment.

(4) There is a danger of eye damage due to UV light.

- Acute impairment: sensation of having a foreign body in the eye, pain, flowing tears

- Chronic impairment: cataract, etc.



- Never look at the LED UV with your naked eyes when lit up. Doing so may cause pain in your eyes or visual impairment. Be sure to wear the included safety glasses.



- Do not apply ultraviolet (UV) light directly to your skin. Doing so may irritate your skin.

### CAUTION



- Touching hot parts such as the LED UV with combustible materials may cause fire or smoke to be emitted. Leaving combustible materials under the LED UV unit for a couple of minutes may also cause fire or smoke emittance.



- Be sure to wear the included gloves when handling the glass on the bottom of the LED UV unit, and never touch it with bare hands. Doing so may significantly lower the UV ink curing level. If the glass becomes dirty, wipe it with clean gauze moistened with ethanol. (Do not use ethanol for cleaning the exterior cover. Doing so will cause the paint to peel off.)



- Always use only a LED UV device and UV power supply unit recommended by Mimaki. The use of any product other than our recommended products may lead to fire or machine damage. Malfunctions caused due to the use of non-recommended products is out of the scope of warranty, and our company does not assume any responsibility for the same.
- Do not drop the glass components, bump them against things, use excessive force on them or scratch them.

## ● Grounding Work

### WARNING



- Increasing the number of power outlets requires installation work to provide grounding to protect against electric shock.
- Carry out the grounding work.
- Always perform grounding to prevent electrocution accidents.

## ● Installation Location and Operating Environment

### WARNING



- To prevent ignition of the ink, do not allow any open flames in the place where the unit is used.



- Be sure to set up an appropriate ventilation system if using this printer in a closed room or a room with poor ventilation.
- This machine is not an explosion-proof type. Do not use the machine in a flammable atmosphere. There is a danger of explosion.
- When constructing an exhaust outlet, please observe the following cautions to prevent malfunctioning of this printer.
  - (1) The extractor outlet must be installed in accordance with applicable local EHS (environmental, health, and safety) guidelines.
  - (2) If the extractor outlet is fitted with a shutoff valve, the valve must be open when this product is in use.



- Do not use the machine in a flammable atmosphere (such as gasoline, flammable sprays, thinners, lacquers, dust, etc.). It may cause a fire or electric shock by ignition.
- Do not bring paper or cloth close to the LED UV unit or cover LED UV unit with it. Doing so may cause fire.



- Do not use in humid places. Do not splash water onto this machine. It may cause fire, electric shock or malfunctioning.



- Keep children away from this machine.

### CAUTION





- Use the printer in a room with as little dust as possible.
- Keep children away from this machine.
- If dust adheres around the head, it may cause ink droplets to fall. Execute head cleaning.
- Maintain this printer in a level horizontal position.

## ● Do Not Climb on the Table



- Never climb on the table where the machine is placed. Doing so may cause the board surface accuracy to go wrong.

## ● Power supply and voltage



- This machine has parts that generate high voltage. Get the electrical work done only from a licensed electrician.



- The set of power cables provided with this machine is for use with this machine only. Cannot be used with other electrical devices. Also, please do not use the power cable set other than the enclosed. Doing so may result in fire or electric shocks.
- Do not use extension cords. Doing so may result in fire or electric shocks.
- Keep the power plug prong clear of any foreign object such as a piece of metal. Failure to do so may result in a fire or electric shocks.
- Do not plug too many leads into a single socket. Doing so may result in fire or electric shocks.
- Do not use the machine if the power cable or plug is damaged. Using the machine with damaged power cable may result in fire or electric shocks. Contact your service representative for replacement of the cable.
- Do not handle the power plug with wet hands. Doing so may result in electric shocks.
- Grasp by holding the plug itself when removing the power plug from wall outlet. Holding and pulling the power cable may damage the cable, leading to fire or electric shocks.
- Do not use the device at a power supply frequency other than the one indicated. Doing so may result in fire or electric shocks.
- Do not use the device at a power supply frequency other than the one indicated. Doing so may result in fire or electric shocks.



- Use this printer with the indicated power specifications. Be sure to connect the power cable plug to a grounded socket in order to prevent fire and electric shock. Failure to do so may result in fire or electric shocks.



- Take care not to damage, break or work upon the power cable. If a heavy material is placed on the power cable, or if it is heated or pulled, the power cable can break, thus resulting in fire or electric shocks.
- The main power circuit breaker should be turned on only by personnel with sufficient knowledge about operating this printer.

## ● Power Supply



- Make sure the breaker is always on.

## ● Power Cable





- Use the power cable provided.

## ● Disposal

### WARNING



- If you want to dispose of this machine, please contact your local distributor or service center. If you want to dispose the machine by yourself, please contact an industrial waste processor.
- Give the waste ink or the ink bottles that you no longer to your local distributor or service center. If you want to dispose of them by yourself, please contact an industrial waste processor or dispose them according to local regulations.

## ● Handling Vacuum

### WARNING



- Never disassemble or modify the vacuum. Also, do not touch the relief valve (pressure regulating valve) or block the vacuum exhaust port. This can cause a decrease in suction force, heat generation or malfunctions. (The vacuum is directly below the table.)

### CAUTION



- Using this machine in a low temperature environment can sometimes cause the vacuum to emit a highpitched sound, but this is not a malfunction.

## ● Handling the antifreeze liquid

### WARNING



- Use the antifreeze liquid recommended by Mimaki. There is a risk of cooling device failure if other antifreez liquids is used. Malfunctions caused due to the use of other anti freezing liquids is out of the scope of warranty, and our company does not assume any responsibility for the same.
- Do not directly touch the antifreeze liquid.  
In case of touching skin or clothing, use soap and immediately flush it with running water.  
If you get antifreeze liquid in your eyes, immediately and thoroughly wash your eyes with clean water. Then, consult a doctor as soon as possible.
- Be sure to read the Safety Data Sheet (SDS) before using the antifreeze liquid.
- If someone accidentally swallows antifreeze liquid, try to get the person to vomit, and then consult a doctor as soon as possible.
- Avoid causing ignition due to static electricity, impact sparks, and similar causes.
- If you accidentally touch hot anti freeze mixture, immediately rinse it off with soap and water, cool adequately with ice water and then consult a doctor as soon as possible.
- Use the following methods to dispose of unneeded anti freezing liquid.
  - (1) Absorb them into such materials as sawdust or a waste cloth, and then incinerate in an incinerator
  - (2) Clearly indicate the contents of the waste to be disposed of and subcontract the treatment of the waste to a licensed industrial waste disposal company



- When handling the anti freezing liquid, be sure to wear the included safety glasses and gloves.



### CAUTION



- Be sure to store the antifreeze liquid in a cold and dark place. Also keep it out of the reach of children.

## ● Do not disassemble or modify this printer

### WARNING



- Never disassemble or modify this machine or ink bottle. Disassembling or modifying will result either in electric shock or malfunction of this machine.

## ● Handling Media

### WARNING



- Do not leave the media set on the machine when returning home for the night. This can cause dust to adhere to the media.

### CAUTION



- Use our recommended media to ensure stable and high-quality printing.
- Be careful about the expansion and contraction of the media. Do not use media immediately after removing from the packaging. Media may expand or shrink depending on the temperature and humidity of the room. After opening the package, let the media sit for at least 30 minutes at the place of use before installing it in the device.
- Do not use curled media. This not only causes media jams, but also affects image quality. Straighten the media before using if it is severely curled. When storing coated fix-sized paper in rolls, make sure the coated surface is on the outside.
- Keep the media away from dust. Wiping dust off the media creates static electricity, which has a counterproductive effect.

## ● Maintenance

### WARNING



- To prevent electric shocks during maintenance, always turn the main power switch off, and remove the power plug. Capacitors of some units may take one minute to discharge. Accordingly, start maintenance work three minutes after turning off the main power circuit breaker and disconnecting the power plug.



- Never touch the areas around where high temperature caution plaques are affixed. Otherwise, you may burn yourself. If you need to touch the high temperature area, wear heat-insulating gloves to protect your hands.



- When cleaning the head, wiper or cap, be sure to wear the included safety glasses and gloves.





- Using the printer in a place exposed to water will increase the possibility of electric leakage. Avoid using the printer in places exposed to water. Electrical leakage may lead to electric shock of personnel or fire.

### CAUTION



- Foreign materials and dust may accumulate on the conductive and insulating parts after using this printer for an extended period, resulting in electrical leakage. Periodically clean such parts.
- Do not blow compressed air. Foreign materials and dust may be scattered, get inside the conductive parts and cause malfunction. Be sure to use a vacuum cleaner to vacuum off foreign materials and dust.
- To prevent accidents, be sure to carry out periodic inspection and replace parts requiring periodic replacement.
- There are parts to be replaced periodically on this machine. We recommend concluding a maintenance contract.
- After this printer is used long time, foreign materials or dust gathered on the stabilizer or other parts may cause electrical leakage or insulation deterioration, resulting in fire or smoke emittance. Periodically clean this printer and replace the deteriorated parts detected by insulation resistance measurement.
- Screws of conductive or other parts may become loose after extended use of this printer, resulting in fire or smoke emittance. Periodically tighten the screws.

## Cautions on Installation

When installing this machine, take the following precautions.

### WARNING



- This machine should be installed in a dedicated private room, in a location where it can be reliably isolated by physical means such as an enclosure. The isolated area should be set up so that no one can easily reach the printer and ink supply unit.
- This isolated area should be prohibited for everyone except the trainees of our safety education program or those who have been trained by such a trainee.  
If an untrained person enters the restricted area while the machine is in operation, there is a risk of accidental contact with the Y-bar that is in the process of printing, resulting in injury.
- This machine should only be operated by the trainees of our safety education program or those who have been trained by such a trainee.

### CAUTION



Use the printer under the following environmental conditions:

- Operating environment: 15 to 30°C (59 to 86°F) 35 to 65% Rh (without condensation)
- Accuracy assurance temperature: 18 to 25°C (64.4 to 77°F)



Do not use the printer in the following environments:





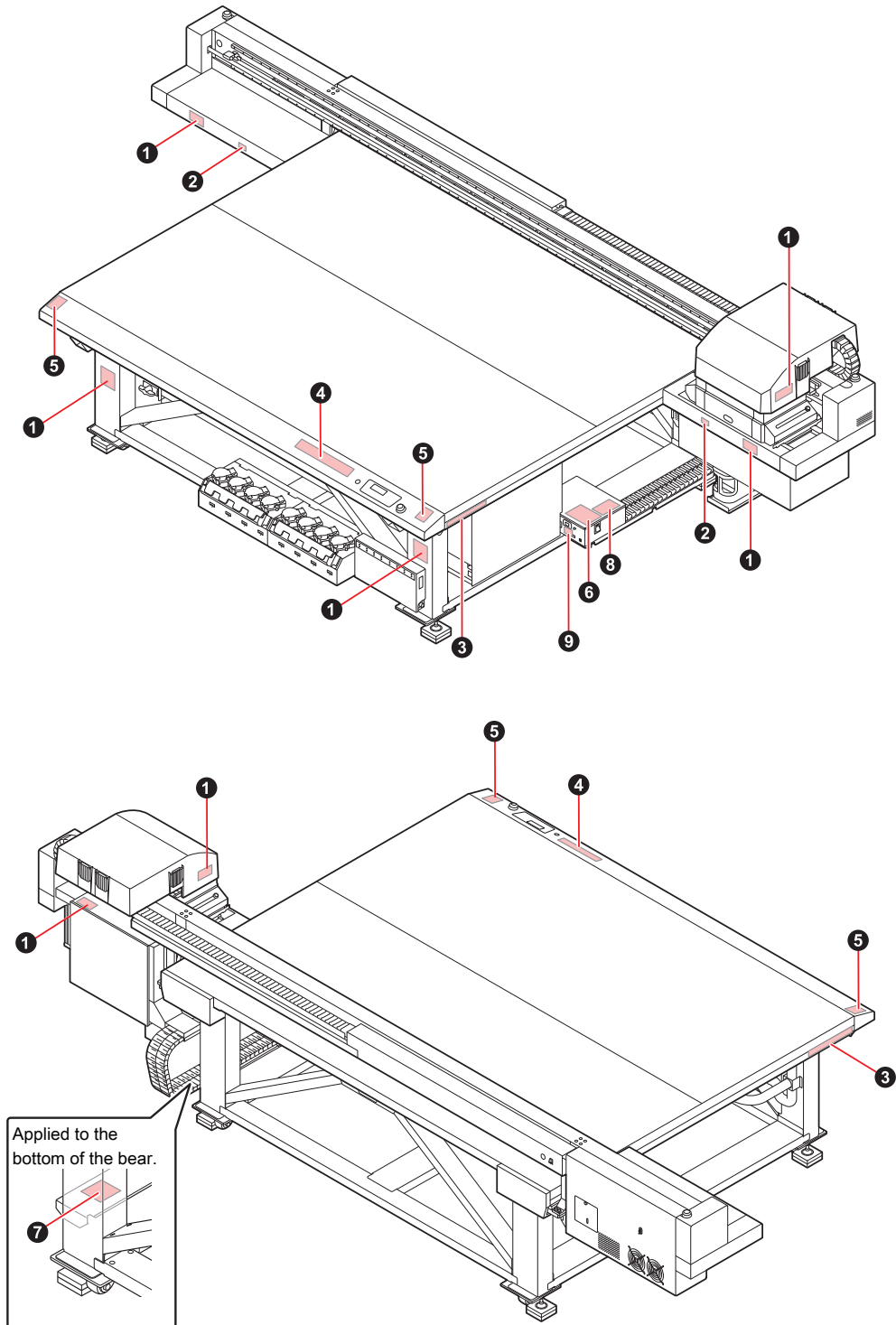

- Exposed to direct sunlight
- Places that are not level  
(If the machine is not level, it may cause poor image quality)
- Where vibration occurs
- Exposed to direct air flow from an air conditioner or similar location
- Near where fire is used
- Places with lots of dust
- Places where there are chemicals

# Warning Labels

Warning labels are affixed to this printer. Be sure to fully understand the warnings indicated on the labels.

If a warning label becomes illegible due to dirt or peels off, purchase a new one from your local distributor or our sales office.

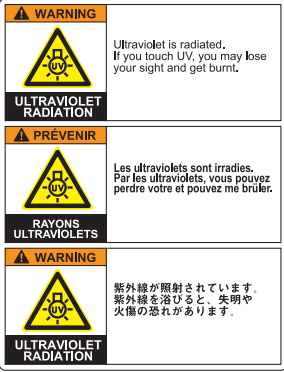

No.	Order No.	Label
1	M909381	
2	M903330	
3	M906115	
4	M902663	
5	M905980	
6	M916117	
7	M909385	
8	M903281	<p>See SET UP GUIDE before connecting to the supply.</p> <p>電源を接続する前に、必ずセットアップガイドを読むこと。</p> <p>在接通电源之前请一定阅读安装说明书。</p>

No.	Order No.	Label
9	M907935	

# 1. Usage Restrictions

## Usage Restrictions

This machine can be dangerous due to parts that move at high speeds, parts with high temperature and UV curing units. This machine is to be used only by those having complete understanding of dangers associated with these parts.

## User Restrictions

This machine should only be operated by the trainees of our safety education program or those who have been trained by such a trainee.

## Area Restrictions

- Only adequately trained and versed individuals are allowed to come closer to the equipment. Set area restrictions within the range shown in the following figure. As for the method of area restriction, the machine should be installed in a dedicated room, and it should be enclosed for everyone to understand that it is a danger zone.
- The danger zone should be prohibited for everyone except the trainees of our safety education program or those who have been trained by such a trainee. If an untrained person enters the restricted area while the machine is in operation, there is a risk of accidental contact with the Y-bar that is in the process of printing, resulting in injury.
- Follow EN ISO13857 standards when securing the area with safety trellis.
- When installing the setup in a dedicated room, install locks and interlocks on the door of the room, and lastly conduct risk assessment at the installation site before use.

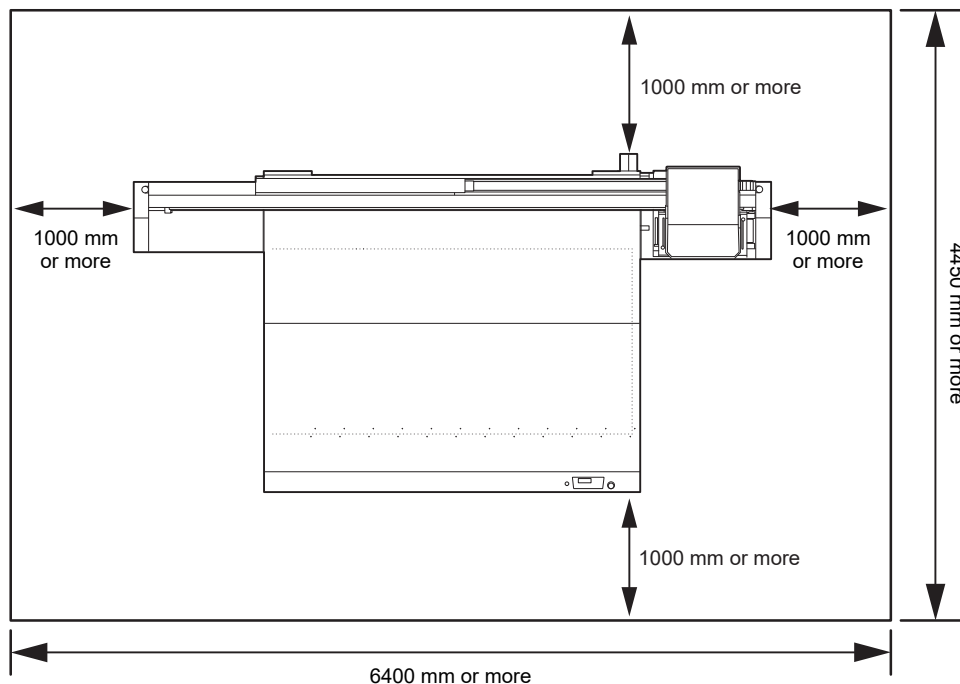



## 2. Avoid These While Operating the Printer

Doing the things mentioned below when the printer is in operation might result in an injury.

- **Do not put your hands or any object on the table**

Do not put your hands on the movement channel of the carriage when the power is on. Also, do not put anything on the table other than the printing paper. Make sure that the thickness of the paper is 50 mm (1.97 inch) or less.



- **Do not disturb the carriage operation**

Do not manually move the carriage during operation (during printing or cleaning). If the carriage is manually moved during operation, an operational error message is displayed.



- **Do not put your hands or any object on the bearing part**

Do not put your hands, feet or any object on the Y-bar or on the bearing part on the right side of the main body.



- **Be careful not to get your hands pinched in the gap between the Y-bar and the carriage**

There is a risk of a person getting handicapped due to crushing or shearing if their hands or other body parts get caught between the Y-bar and the carriage.  
Do not put your hands in the gap between the Y-bar and the carriage when the power is on.



- **Be careful not to get your hands pinched in the gap between the carriage and the table**

Do not put your hands in the gap between the carriage and the table when the power is on.



- **Do not put your hands or any object in the moving range of the carriage**

If the carriage moves too fast, your hands may get caught in it.



- **Keep your hands away from the Y-bar and the carriage when the power is on**

There is a risk of hands getting crushed due to the movements of Y-bar and carriage.  
Keep your hands or other body parts away from this area and the printing range when the power is on.



- **Be careful not to get your hands caught in the carriage or the maintenance station portion**

Do not put your hands in the carriage or the maintenance station portion.



- **Be careful not to get your hands pinched in the gap between the Y-bar and the table**

Do not put your hands in the gap between the Y-bar and the table when the power is on.



- **Be careful about belt winding malfunction**

Be careful not to get your hands dragged into the Y-bar belt. There is a risk of hurting your hands or objects getting sucked.



- **Do not place any object in front of the exhaust port of suction vacuum**

The object may get deformed due to the heat released from the exhaust port.

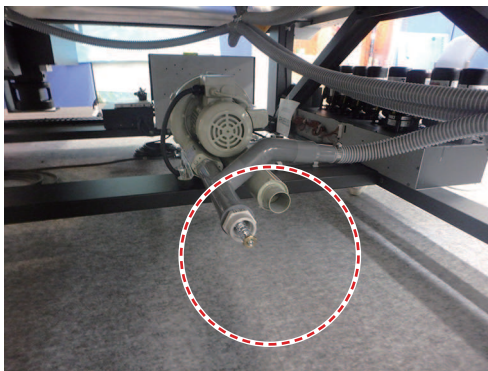

- **Do not crawl under the table when the power is on**

It is extremely dangerous as you may get caught in the fixed parts or the movable parts under the table.

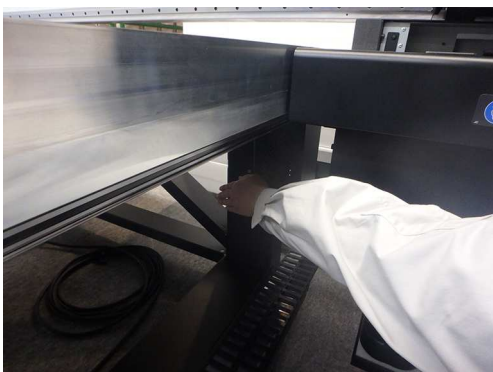

- **Do not bring your hands anywhere near the rack gear and the motor cover under the table**

You may get your hands caught in the gears resulting in injury.

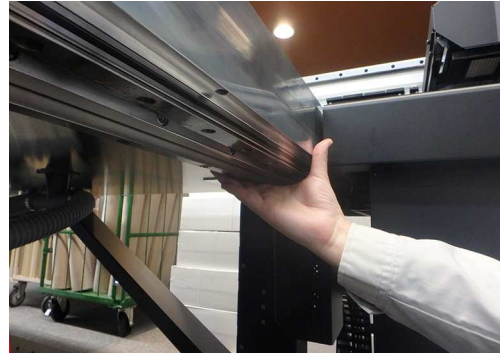
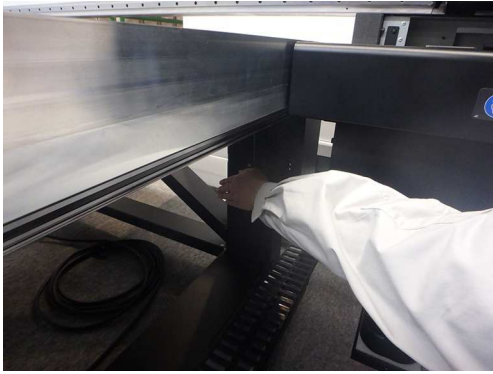

● **Be careful not to accidentally press the key panel switch by mistake**

Pressing this switch accidentally may cause sudden operation leading to an unexpected accident.

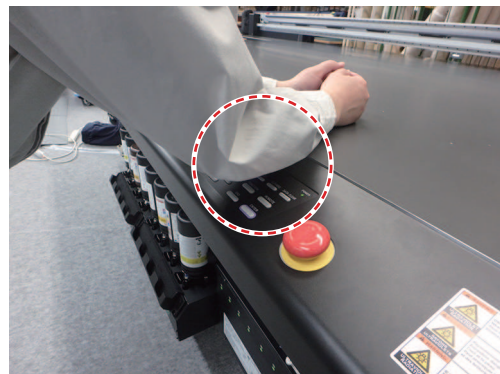

● **Be careful not to look directly at the UV light**

Do not directly look at the UV light.

- Be careful when your head and carriage are at the same level; for example when you are sitting on a chair while working.  
Be particularly careful of UV light leakage when setting carriage and thick media.
- Be careful about UV light leakage at each of the following spots when printing.  
Edge of the table  
Back side of the carriage (behind Y-bar)  
Top of the carriage part

Also, you may burn yourself from the LED UV unit and the parts around it, that have turned hot. Be careful not to touch.



● **Wear safety glasses when using the machine**

It is recommended to wear safety glasses when using the machine to prevent eye damage due to UV light leakage.

## ● Pay attention to following when replacing the ink

- To prevent the ink from sticking to your hands or eyes when it splashes, be sure to wear the included safety glasses and gloves.
- Do not pull the ink cover too much.  
Pulling it too much might damage the tubes and cables.
- Replace the ink bottle after cleaning the surroundings with a waste cloth, etc. The portion around the bottle becomes dirty as the ink oozes from the float part.

## ● Wear safety glasses and gloves when performing maintenance

When performing maintenance such as ink replacement, be sure to wear the included safety glasses and gloves.

Also, wear a gas mask if necessary.

# Confirmation for agreement

Copy for customer

## Confirmation for agreement

I agree to make my employees take proper safety training course performed by your company at installing this machine in accordance with the document "Safety Precautions" (D203453) of this machine (JFX200-2513EX). I also agree that only the employees who took the relevant safety training course or those who took training from him/her can use this machine.

Date: \_\_\_\_\_

Company name: \_\_\_\_\_

Representative: \_\_\_\_\_

Cutoff line	Sign	Date	Cutoff line
-----			

Copy for maker

## Confirmation for agreement

I agree to make my employees take proper safety training course performed by your company at installing this machine in accordance with the document "Safety Precautions" (D203453) of this machine (JFX200-2513EX). I also agree that only the employees who took the relevant safety training course or those who took training from him/her can use this machine.

Date: \_\_\_\_\_

Company name: \_\_\_\_\_

Representative: \_\_\_\_\_









## **JFX200-2513EX Safety Precautions**

---

---

January, 2021

**MIMAKI ENGINEERING CO.,LTD.**

2182-3 Shigeno-otsu, Tomi-shi, Nagano 389-0512 JAPAN

---

---

D203453-11-20012021

